

Digital Photogrammetric System

PHOTOMOD

Version 8.0

USER MANUAL

Vectorization
(Windows x64)



Table of Contents

1. Purpose of the document	7
2. About vectorization	7
2.1. Main conventions and terms	7
2.2. Stereovectorization	8
3. Preparing to stereovectorization	8
3.1. Stereo image settings	8
3.2. Stereo modes	9
3.2.1. Anaglyph mode	9
3.2.2. Page-flipping mode	9
3.2.3. Polarization mode	9
3.2.4. Pseudo-stereo mode	10
3.3. Stereopair selection	12
3.3.1. Pass to adjacent stereopair	12
3.3.2. Pass to chosen stereopair	13
3.3.3. Automatic stereopair selection	16
3.4. The marker management	16
3.4.1. The “Marker” window	16
3.4.2. Marker modes	18
3.4.3. Snap-to-ground mode	20
3.4.4. Streamline mode	20
3.4.5. Fixation of Z	21
3.4.6. Snapping mode	21
3.5. Creation of “stereo quality” map	38
3.6. Measurements on images	42
4. Vector layer creation	44
4.1. Vector layer display settings	45
5. Vector objects	46
5.1. The “Vectors” toolbar	46
5.2. Types of vector objects	47
5.3. Creation of vector objects	48
5.3.1. Points creation	48
5.3.2. Polylines creation	48
5.3.3. Polygons creation	48
5.3.4. Creation of orthogonal objects	49
5.3.5. CAD-objects creation	50
5.3.6. Roofs creation	56
5.3.7. Building height calculation	83
5.3.8. Vector object properties	89
5.4. Vector objects loading	90
5.5. Vector objects saving	93
5.6. Displaying objects list	94
6. Classifier	96
6.1. The “Classifier” window	96
6.2. Classifier creation	98
6.3. Classifier editing	101
6.4. Classifier import	103
6.5. Labels creation	103
6.6. Association of vector objects with classifier	104
6.7. Conversion of vector objects types	105
7. Vector objects attributes	106
7.1. The “Attributes” menu	106
7.2. Creation of vector objects attributes	107
7.2.1. Attributes creating and editing	107

7.2.2. Creation attributes in layer without classifier	111
7.2.3. Adding required attributes of a layer	112
7.2.4. Arithmetic operations on attribute values	114
7.3. Vector objects labels	118
7.3.1. Labels creation	118
7.3.2. Labels attributes	119
7.4. Attributes assigning	121
7.4.1. Assigning of unique attribute value	121
7.4.2. Save the objects height in the attribute	122
7.4.3. Assigning height from attribute	123
7.4.4. Automatic filling layer's attributes	124
7.4.5. Objects collation	126
7.4.6. Using attributes when building 3D-objects	127
7.5. Operations with objects using attributes	129
7.5.1. Merging point objects by attribute	129
7.5.2. Object search using attribute value	130
7.5.3. Select by attribute value range	132
7.5.4. Custom object paint	133
7.6. Attribute value range	134
7.7. Attributes value interpolation	134
7.8. Layer's semantics check	135
7.9. Calculation canopy of forest	138
8. Operations with vector objects	141
8.1. The "Edit" menu	141
8.2. Vector objects selection	143
8.2.1. Objects selection tools	143
8.2.2. Objects selection modes	144
8.2.3. Selecting classifier layer object	145
8.3. Vector objects copying	146
8.4. Vector objects editing	147
8.4.1. Vertices editing	147
8.4.2. Adding vertices to a line segment	148
8.4.3. Polyline moving	148
8.4.4. Polyline deleting	149
8.5. Vector objects interpolation	149
8.5.1. Quick linear vector objects interpolation	149
8.5.2. Corners round off	150
8.5.3. Vertices thinning out	153
8.5.4. Interpolation by Bezier curve	153
8.5.5. Elevations interpolating	156
8.5.6. Convolution smoothing	157
8.5.7. Smoothing vector objects	158
8.5.8. Vertices densification	159
8.6. Editing of smooth curves	160
8.6.1. The "Curve transforms" menu	160
8.6.2. Smooth curves creation mode	160
8.6.3. Conversion of smooth curves	160
8.6.4. Automatic smoothing	161
8.6.5. Editing of curve line segments	161
8.6.6. Smoothing control	161
8.7. Undo editing operations	162
8.8. Additional coordinate system	163
9. Vector objects filtering	164
9.1. Points filtering by Z-range	164

9.2. Median points filtering by Z	165
9.3. Filter of adjacent point objects	166
9.4. Filtering of linear objects	166
9.5. Surface objects filter	167
10. Geometric transformations of vector objects	168
10.1. Transformation of vector objects	170
10.1.1. Vector objects moving	170
10.1.2. Converting polygons to points	171
10.1.3. Conversion of vector object to geometric shape	172
10.1.4. Correcting by residuals vectors	173
10.1.5. Cut vectors by selected polygons	174
10.1.6. Cutting objects around selected vectors	179
10.1.7. Splitting objects into layers depending on type	180
10.1.8. Vector objects transformation	180
10.1.9. Fast vector objects transformation	182
10.1.10. Alignment mode	183
10.1.11. Projective transform	191
10.2. Creation of additional vector objects	192
10.2.1. Adding intersection points	192
10.2.2. Creating a symmetric objects	193
10.2.3. Building buffer zone	199
10.2.4. Geometric figures around objects vertices	201
10.2.5. Creation of profiles through selected objects	202
10.2.6. Checking orthogonality of polygons corners	203
10.2.7. Extraction of vector objects by spatial relationship	204
10.3. Vector objects projecting	206
10.3.1. Projecting onto relief	206
10.3.2. Vectors projecting on a TIN	207
10.3.3. Vectors projecting on a DEM	208
10.4. Deleting point objects using a parameter	209
10.4.1. Delete points around linear objects	209
10.4.2. Deleting points inside polygons	210
10.5. Transformation of objects coordinates	211
10.5.1. Swap of X and Y coordinates	211
10.5.2. Change objects coordinate system	211
10.6. Transformation of CSV file	213
10.7. Elevation profile of a linear object	215
10.8. TIN area info	216
11. Topological operations	216
11.1. About topology	216
11.2. The "Topology" menu	217
11.3. Vertices connection	218
11.3.1. Topological connectivity mode	218
11.3.2. Joint points editing mode	219
11.4. Object editing	220
11.4.1. Polylines closing	220
11.4.2. Polygons unclosing	221
11.4.3. Merging of polylines/polygons	221
11.4.4. Splitting polylines/polygons	222
11.4.5. Cut out area from polygon	226
11.4.6. Duplication of vector objects	228
11.4.7. Filling the attributes after topological operations	229
11.5. Connecting to an object	230
11.6. Editing of object fragment	231

11.6.1. Adding/deleting object fragment	231
11.6.2. Fragment replacing	232
11.6.3. Segment deleting	232
11.6.4. Replacing an object's segment by an object's fragment from another layer	233
11.6.5. Reverting vertices order	234
11.6.6. Removing vertices together with adjacent segments	234
11.7. Creating common border	235
11.7.1. Continuing along polyline	235
11.7.2. Auto-close along polyline	236
11.8. Topology control	237
11.8.1. Topology verifying	237
11.8.2. Check polygons relative position errors	239
11.8.3. Search for polygons with coinciding points	239
11.9. Editing of polygonal layer	240
11.9.1. Layers intersection	240
11.9.2. Layers subtraction	241
11.9.3. Filling null areas	241
12. Vector data editing using *.x-mdata file	244
12.1. Vector data conversion to *.x-mdata	244
12.2. *.x-mdata editing	245
13. Import of vector objects	246
13.1. Import from ASCII	246
13.2. Import from ASCII-A	247
13.3. Import from CSV	250
13.4. Import from DGN	253
13.5. Import from DXF	255
13.6. Import from Generate	258
13.7. Import from ATLAS KLT	259
13.8. Import from KML / KMZ	261
13.9. Import from LAS	262
13.10. Import from LIG	263
13.11. Import from MIF / MID	264
13.12. Import from Shape	266
13.13. Import from Panorama	268
13.14. Using DBF file	271
13.15. Batch import	271
13.16. Import from GDAL formats	272
13.16.1. Import from GeoPDF	273
14. Export of vector objects	274
14.1. Export to ASCII	274
14.2. Export to ASCII-A	275
14.3. Export to CSV	276
14.4. Export to DGN	279
14.5. Export to DXF	281
14.6. Export to Generate format	288
14.7. Export to ATLAS KLT format	289
14.8. Export to KML / KMZ	290
14.9. Export to LAS	291
14.10. Export to LIG	291
14.11. Export to MIF / MID	292
14.12. Export to PLY	294
14.13. Export to Shape	295
14.14. Export to Panorama / SXF	297
14.15. Batch export of layers	299

- 14.16. Batch export of resources 301
- 15. Generators of splitting into sheets 303
 - 15.1. Standard orthomap sheet frames generator 303
 - 15.2. Custom orthomap sheet frames generator 305
 - 15.3. Standard orthomap sheet frames importer 308
- 16. Co-editing vector layers 312
 - 16.1. Co-editing topologically connected vector objects 314
- 17. ArcSync. Synchronized vector edition 314
 - 17.1. The main window of ArcSync 314
 - 17.2. Workflow 315

1. Purpose of the document

This document contains detailed information about vectorization in the *PHOTOMOD* system. It describes work with vector layers, including classifier, as well as features used for vector objects creation and editing, and topology check of created objects. The document also contains a description of all types of import and export in the *PHOTOMOD* system.

2. About vectorization

2.1. Main conventions and terms

This documentation uses the following concepts:

- *Vector graphics* – way of image objects presentation, based on using elementary geometric objects, such as points, lines, broken lines, splines, polygons, described by mathematical functions in contrast to raster graphics, where each object is a set of points (pixels);
- *Vector object* – 2D or 3D-object of vector graphics, described by mathematical function and belongs to one of the following objects types in the system: point, polyline, polygon;
- *Point* – a point object, which is determined by XY coordinates in the plane and by XYZ coordinates in space;
- *Polyline* – a broken line or a curve, containing a set of vertices, joined by straight or curve line pieces called segments;
- *Polygon* – an areal object, which boundaries are closed polyline;
- *CAD-objects* - standard geometric figures, for example, ellipse, circle, rectangle, arc, that are polylines or polygons (see [Section 5.3.5](#));
- *Vertex* – a point, connecting polyline or polygon segments;
- *Segment* – a straight line, connecting two vertices;
- *Fragment* – a part of polyline/polygon, a set of adjacent vertices/segments of polyline/polygon;
- *Vectorization* – an operation of vector objects creation on a vector layer, for example, for generation of digital maps.

2.2. Stereovectorization

Stereovectorization – an operation of terrain objects vectorization in stereo mode using stereo model, that allows to create digital elevation models and 3D topographic maps.

Stereomodel builds by stereopairs during block adjustment (see the “[Block adjustment](#)” User Manual).

Stereopair – two images for the same terrain acquired from different points of view that have overlap area.

When viewing a stereopair in such a way that each eye can see only one of the images, user can imagine three-dimensional (stereoscopic) picture, reproducing depth of the real object. Stereopairs formed by airborne and space borne images are used to create digital maps and DEM.

During survey images can have *in-strip* (inside a strip) and *inter-strip* (between strips) *overlap*. For stereo effect of optimal quality images have to have the following overlap size: in-strip overlap – at least 60% of image width, inter-strip – at least 20% of image height.

Stereo mode – a mode when each eye can see only one of two images, with stereoscopic effect as a result. It is used for stereo viewing of stereo model, and it is provided by hardware devices and monitor technical features.



Prior to start vectorization operation it is necessary to perform block adjustment in free or non-free model (see the “[Block adjustment](#)” User Manual).

3. Preparing to stereovectorization

3.1. Stereo image settings

When working in stereo mode to obtain the best stereo effect in created vector object area it is recommended to tune stereo image depth. This is important when working with “deep” images, i.e. images with a large Y-parallax difference in stereoscopic viewing area.

To tune stereo place marker to necessary area and project it on object or relief surface (see [Section 3.4](#)). Click the  button or press the **F2** key. Images are moved in such a way that parallax gets zero value in marker position, and the best stereo is obtained in this point vicinity or in its “depth”.



In order to activate *Automatic adjusting parallax in stereo mode* choose **Service > Settings** or click  button of the main toolbar. In **Settings** window select **Control** tab and in the section **Automatically adjust parallax in stereo mode** set the **Activate, with threshold** checkbox. *Threshold of changing marker height* is a value with which automatic adjusting parallax in stereo mode is performed. Threshold value is specified in pixels in corresponding field.

To restore basic stereoscopic effect “depth” click the  button of 2D window toolbar or use the **F3** hotkey.

To change stereo mode phase (i.e. to switch between left and right images) click the  button of 2D window toolbar or use the **F11** hotkey.

To change stereo image depth use the **Shift+Page Up/Page Down** or **Shift+mouse wheel** hotkeys.

3.2. Stereo modes

3.2.1. Anaglyph mode

In anaglyph mode a stereo image is formed using digital coding of stereopair images, that are intended for the right and left eyes, by the “red” and “blue” colour filters correspondingly. To view and measure in anaglyph stereo mode it is necessary to use dedicated spectral anaglyph glasses with the same filters.

Anaglyph mode for stereo measurements does not depend on monitor and graphics card parameters. The main disadvantage of anaglyph mode is inability to work with full color images.



Anaglyph mode of stereoscopic visualization is used in HighColor or TrueColor monitor graphic mode only.

3.2.2. Page-flipping mode

Page-flipping stereo mode provides quality stereo image using full frames. The left and right images are shown on the screen synchronously with frames changing. Synchronization of shutter glasses with vertical interlace of monitor allows to view two images at the same time and to perform stereo measurements on them. A prerequisite of the page-flipping mode is the presence of an appropriate video adapter, and monitor with stereo mode support.

To work in page-flipping mode it is necessary to use shutter stereo glasses. Shutter glasses are glasses with liquid crystals, which are synchronized with vertical interlace of monitor. The system supports page-flipping stereo measurements mode using shutter glasses. To learn more about using the stereo glasses and other special equipment for stereo measurements.

3.2.3. Polarization mode

To view stereo image on stereo monitor screen, which use polarization effect to divide the right and left images of stereopair superimposed on the screen or on a special translucent mirror, there are special polarized glasses. Polarized 3D-glasses (in contrast to shutter 3D-glasses) not fitted with wires and looks very similar to normal vision glasses.



Polarized 3D-glasses are included to stereo monitor delivery set, that supports this mode.

Polarized stereo glasses contain special polarized lenses with transparent polarizing film (polarization filter) inside. This film has the ability not to pass the light rays having a certain direction of transverse vibrations (certain direction of polarization), and does not prevent the passage of the rays with the other polarization directions. Polarized 3D-stereo glasses polarizing filters in the left and right lenses are orthogonally rotated relative to each other. That is why combination on the screen or on a special mirror of orthogonally polarized left and right stereo pair images are divided in the polarizing filter glasses to separate images for the left and right eyes.

3.2.4. Pseudo-stereo mode

The system allows to work in pseudo-stereo mode in the block scheme window.

Pseudo-stereo – is a stereo mode, where orthogonal projection is used for left eye, and for right eye – parallel projection with some angle to normal line. This mode allows to display to raster layers as one stereo image.



Pseudo-stereo mode has no metric characteristics and couldn't be used for stereo measurements.

In order to turn on the pseudo-stereo mode perform the following actions:

1. Choose **Service** › **Settings (Ctrl+Alt+P)**. The **Settings** window opens.
2. On the **Windows** tab set the **Allow pseudo-stereo in block scheme window** checkbox.
3. [optional] To define an angle of projection to normal line, specify the **Separation** parameter.
4. Click OK. To apply the changes, close block 2D-window and then open it again. To do this choose **Window** › **2D-window (block)**.
5. The buttons are the same as buttons in stereopair 2D-window. Buttons used to turn on and setup stereomode are added in 2D-window toolbar.
6. Choose **Raster** › **Load georeferenced image (files)** or **Raster** › **Load georeferenced image (resources)** and select two images to be loaded from file system or from projects resources. The **Load georeferenced image** window opens.



See more in the “Georeferenced external data” chapter of the “[Aerial triangulation](#)” User Manual.

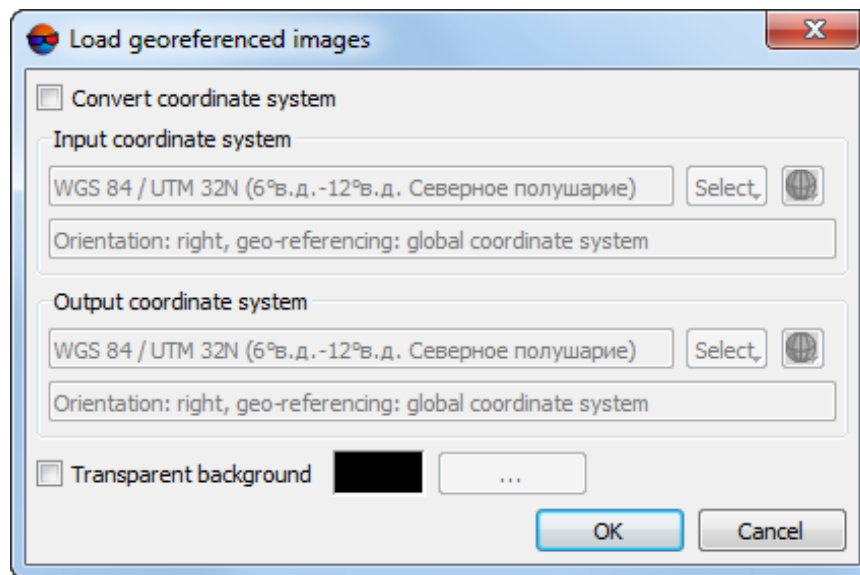

Fig. 1. Loading images

7. [optional] To change image coordinate system set the **Convert coordinate system** checkbox on (see the [Section 10.5.2](#)).
8. [optional] When loading multiple images at once the **Load** window opens. Select **Create separate layer for each file**. After that the images loads to two separate raster layers.

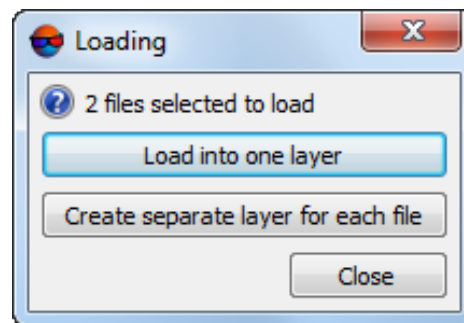

Fig. 2. Loading more than one image

9. Right click the layer with the “left” image in the Manager. In the context menu choose the **Raster layer parameters** item. The **Raster layer parameters** window opens.

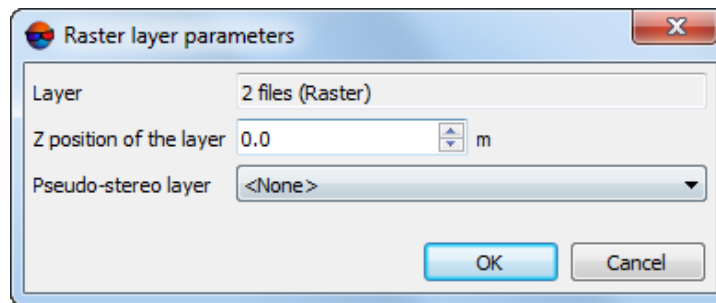

Fig. 3. Raster layer parameters



10. [optional] To set the layer Z level, specify a value in the **Z position of the layer** field.



This value is used as a elevation of stereo zero-parallax (not only for stereoscopic image formed with the other layer, but for a usual raster layer when the stereo is on in block scheme window). If current layer contains stereoscopic image formed with the other layer, then the layer Z position, specified in the window, is applied to both layers.

11. In the **Pseudo-stereo layer** list select the layer with the “right” image. Raster layer with the “left” images becomes stereo layer.

In order to estimate a result of obtained pseudo-stereo image perform the following actions:

1. Turn on the stereo mode in the block scheme window. To do this click the  button.
2. Turn off visibility of layer with image, selected as the “right” one, by clicking the  button next to the layer name in the Manager.

3.3. Stereopair selection

3.3.1. Pass to adjacent stereopair

The system provides possibility to pass to the adjacent stereopair when working in 2D-window.





In the navigation window displays the left image of the stereopair.



When vectorizing lengthy objects – for example, roads or rivers, that passes through the whole images block – it is recommended to perform vectorization by sequential passage of stereopairs. At that the system allows to preserve marker position, zoom, parallax value and vector objects activity during smooth continuation of 3D vectorization (see the “[General system’s parameters](#)” User Manual).

To pass to another stereopair use the following menu items in 2D-window **Window > Stereopairs** and buttons of the **Change stereopair** additional toolbar.

Table 1. Brief description of the “Stereopairs” menu

Buttons and menu items	Function
➔ Next stereopair (Ctrl+Alt+RIGHT)	to open a stereopair with next image in the strip
➔ Previous stereopair (Ctrl+Alt+LEFT)	to open a stereopair with previous image in the strip
⬆ Stereopair up (Ctrl+Alt+UP)	to pass to a stereopair located on one strip up
⬇ Stereopair down (Ctrl+Alt+DOWN)	to pass to a stereopair located on one strip down
 Select stereopair	to select an arbitrary stereopair to pass to
 Auto change stereopair (Ctrl+J)	to choose the best next stereopair related to marker position and move to it
Open reverse stereopair	to swap images of opened stereopair and to rotate image by 180 degrees

3.3.2. Pass to chosen stereopair

To select an arbitrary stereopair to pass to, choose **Window > Stereopairs > Select stereopair** or click the  button on the **Change stereopair** toolbar. The **Select stereopair** window opens.

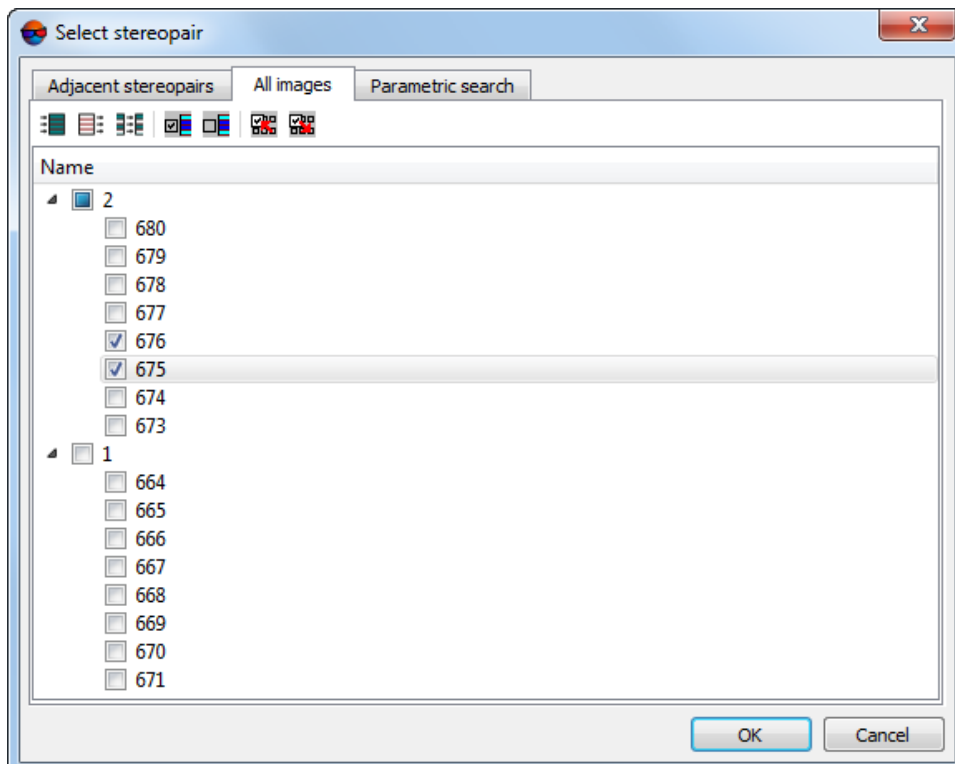









Fig. 4. The Select stereopair window

On the **Adjacent stereopairs** tab the system displays a list of all possible stereopairs, including those formed by non-adjacent images or images from different strips provided that all of them are overlapped.

On the **All images** tab a list of all project images displays. Images of the opened stereopair are marked by checkboxes.

The toolbar on the **All images** tab contains the following buttons:

-  – allows to select all images;
-  – allows to unselect all images;
-  – allows to reverse image selection in the table;
-  – allows to select highlighted images;
-  – allows to unselect highlighted images;
-  – allows to select images, highlighted on the block scheme;
-  – allows to highlight selected images on a block scheme.

The **Parametric search** tab is used to select a stereopair using parameters displayed in the table containing the following columns:

- **Score, %** – a score of stereo quality for block stereopairs;
- **Intersection angle, degrees** - an angle between photographing beams at the current terrain point (in marker position);
- **Distance to the boundary, pix.** - the shortest distance from the current marker position to the stereopair boundary;
- **Heading, degree.** - rotation angle of airframe in horizontal plane measured from the north direction (countdown of positive angles counter-clockwise when viewed from above);
- **Roll, degree.** - rotation angle (roll angle) of aircraft in relation to roll axis;
- **Pitch, degree.** - rotation angle of aircraft to main transverse axis of inertia or angle between aircraft roll axis and horizontal plane;
- **Basis angle, degree.** - angle between photographic image base and coordinate system plane;
- **Ray angle, degree.** - angle between ray and coordinate system plane;

- **Projection center height, left image, m** - projection center height for left image, in meters;
- **Projection center height, right image, m** - projection center height for right image, in meters;



Stereopair table displays a list of all stereopairs found in marker's position and the system automatically selects an optimal stereopair (active stereopair) there, i.e. block stereopair with the best quality of stereo. This stereopair is assigned the highest rating.

To select an optimal stereopair (by parameters) perform the following actions:



For VisionMap A3 projects it is not recommended to use parametric mode of stereopair selection.

1. In the **Selection mode** section specify one of the following ways of optimal stereopair selection:



Mode of active stereopair selection and configuring of selection parameters leads to recalculating of stereo quality score of all stereopairs in the table.

- **By stereo angle** - allows to select an active stereopair by optimal or specified stereo angle;
 - **By distance to the boundary** - allows to select an active stereopair by distance from current point in marker's position to stereopair's boundary;
 - **Advanced** - allows to find an active stereopair which features satisfy extended set of specified parameters values.
2. [optional] Specify optimal parameters values for selected mode in the **Optimal value** section. To configure parameters use calculated value from active stereopair or specify fixed value (with indication of weight percentage for the advanced mode).
 3. [optional] Define a range of acceptable values of specified parameters in the **Limits** section. The system suggests by default to specify limits (minimal and maximal values) for stereo angle. To define a range of acceptable values of other parameters set the **Show all limits** checkbox on.

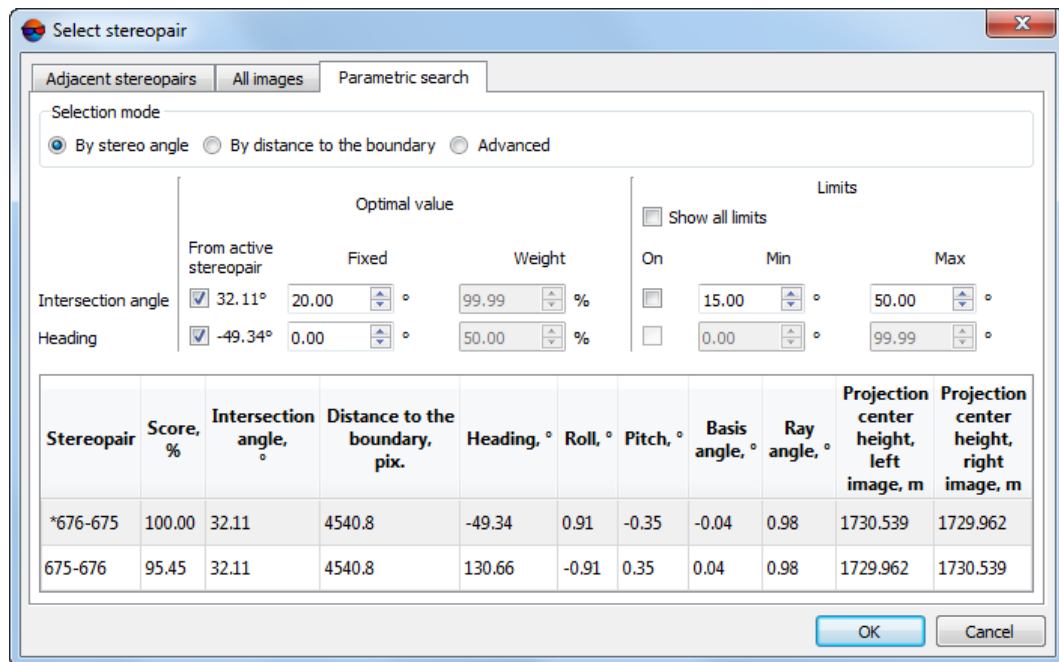



Fig. 5. Parametric stereopair search

To pass select a stereopair on one of the tabs and click OK.

3.3.3. Automatic stereopair selection

The system provides possibility to search for the best stereopair and to pass to it automatically during stereo vectorization.

To select the best stereopair automatically perform the following actions:

1. Place marker in the vicinity of the vectorization object.
2. Click the  button (**Ctrl+J**). The system calculate the best stereopair to pass to, using a value of intersection angle in relation to marker.

3.4. The marker management

3.4.1. The “Marker” window

The system provides possibility to display current marker coordinates both in project coordinate system and WGS-84 geodetic coordinate system, as well as marker move to a point with specified coordinates. The **Marker** window is used for this purpose.

To display current marker coordinates in the project coordinate system choose **Window > Marker window** or click the  button of the main toolbar. The **Marker** window opens.

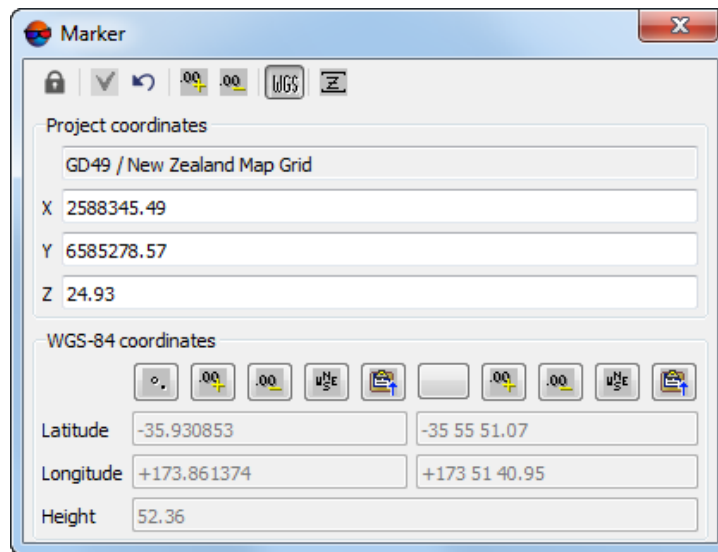

Fig. 6. The Marker window

The top toolbar contains the following buttons:

- - allows to change marker's position just after input of coordinates values without clicking the button or press **Enter**.
- - allows to move marker in accordance with specified coordinates;
- – allows to cancel changes and return to initial coordinates;
- - allows to increase number of displayed decimal places by one;
- - allows to decrease number of displayed decimal places by one;
- – allows to show/hide bottom part of the window to display geodetic marker coordinates in WGS-84;
- – allows to fix the marker value by Z coordinate (**Alt+Z**). Is used on vectorization and editing of lines on a constant Z (see the [Section 3.4.5](#)).

The bottom part of the window displays geodetic marker coordinates (latitude/longitude/height). The toolbox contains the following buttons:

- - allows to change display format of geodetic coordinates;
- - allows to increase number of displayed decimal places by one;
- - allows to decrease number of displayed decimal places by one;
- - allows to turn on display format of units and hemispheres;

-  allows to copy coordinates to clipboard (**Ctrl+C**).



Only plane coordinates copies by default. To copy all coordinates, click the button while holding **Alt** key.

In order to change marker position in project coordinate system perform the following actions:

1. Choose the **Window > Marker window** or click the  button of the main toolbar. The **Marker** window opens.

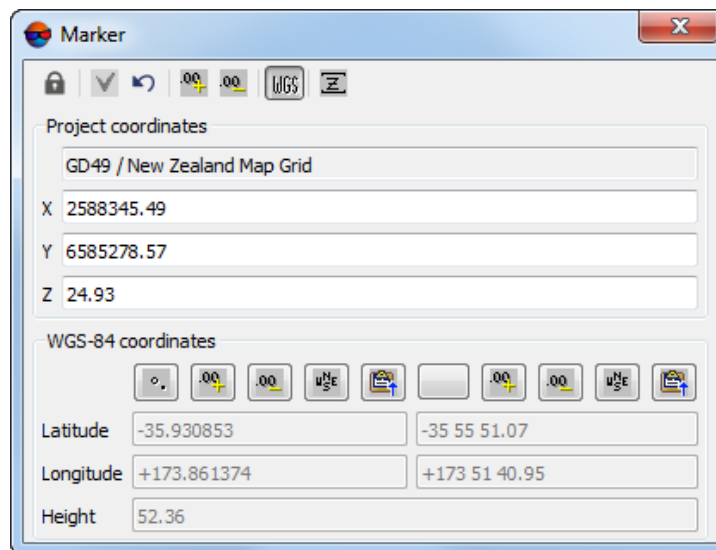



Fig. 7. The Marker window

2. Input coordinates of a point to move marker to in the **Project coordinates** section.



[optional] To change marker's position automatically just after input of coordinates values click the  button.

3. Click the  button or press the **Enter** key. After that marker is moved to the point with specified coordinates.

3.4.2. Marker modes

Depending on the object of vectorization for different stereo vectorization methods the system provides the following modes of marker work:

- *moving marker mode* – the marker moves arbitrarily by image “fixed” in XY plane.

Use arrow keys to move marker in XY plane. Use the **Page Up** and **Page Down** hotkeys or rotate mouse wheel to set marker by Z.



Moving marker mode is used in the system by default.

-  **fixed marker mode (F6)** – marker is always in the center of the screen, horizontal parallax on it is zero.



In fixed marker mode a step of model move by Z is defined arbitrarily.



Fixed marker mode is intended for users who have work experience on stereo devices. The advantage of the mode is the ability to vectorize extended objects continuously with a constant automatic moving of image.

To place the marker on the surface of relief model in stereomode use the **Page Up** and **Page Down** hotkeys (in XY plane) or mouse wheel rotation to move marker by Z. To move image in XY plane use mouse or arrow keys.

-  **marker=mouse mode (F4)** – mouse cursor is invisible, all mouse moves lead to marker moving without additional clicks of mouse buttons.



This mode is used for vectorization of extended objects breaklines.



The marker=mouse mode is not available if the [alignment mode](#) is enabled.

- [orthogonal mode](#) – allows to create orthogonal objects; in this mode marker moves at a right angle;
- [snap-to-ground mode](#) – marker is automatically positioned on the relief;
- [streamline mode](#) – points are added continuously by set distance while mouse button is pressed;
- [fixing by Z](#) – marker has fixed elevation value.



Step of marker moving along Z axis is discrete and inversely proportional to the current image increase when scaling. For fast marker moving along Z use mouse wheel rotation while holding pressed **Alt** key.

The system also allows to place marker on a model surface automatically using correlator. The **Space** key is used to do this.

- [optional] If the correlator failed to work the **Status** panel displays the Bad point message and the system produces warning audio signal;
- [optional] In case of successful correlator operation, correlation coefficient (Corr) and autocorrelation coefficient (AQ) values are displayed in the **Status** panel.



High autocorrelation coefficients may indicate that the marker is located in an area containing contrasting, but similar and adjacent objects, mainly of anthropogenic origin, for example sections of a railway track or road markings.



To configure threshold values of the correlation coefficient and autocorrelation coefficient, choose **Service > Settings**. The **Settings** window opens. Set the required values in the **Block scheme** section of the **Correlator** tab (see the “Correlator settings” in the “[General system’s parameters](#)” User Manual).

To set up marker parameters choose the **Service > Settings**. The **Settings** window opens. It is possible to configure shape, color and size of marker in the **Windows** section on the **Marker (stereopair)** tab (see the “[General system’s parameters](#)” User Manual).

To change horizontal parallax in stereo mode the system provides the **Shift+PgUp/PhDn** hotkeys, and **Shift+mouse wheel rotation**.



For fast parallax change for high values, move the mouse while holding **Alt+Shift+mouse middle button**.

To change horizontal parallax in *fixed marker mode* it is possible to use **Shift+mouse wheel rotation** and **Ctrl+Shift+mouse wheel rotation** hotkeys by X and Y accordingly. To set parallax to zero in marker position the **F3** hotkey is used.

3.4.3. Snap-to-ground mode

For automatic place marker on terrain relief during stereo vectorization the system provides the **snap-to-ground mode** – a mode of automatic marker following the relief. To enable the snap-to-ground mode choose **Edit > Snap-to-ground mode (T)** or click the  button of the **Vectors** toolbar.

In this mode marker moves on XY plane and automatically set by Z (with correlator).



If the correlator failed to work the **Status** panel displays the **Bad point** message and the system produces warning audio signal. In this case it is possible to place marker on the relief manually using mouse wheel or the **Page Up**, **Page Down** keys.

3.4.4. Streamline mode

The system provides possibility to vectorization in streamline mode. In this mode points add automatically by set distance.

To enable the streamline mode choose **Edit > Streamline mode (Y)** or click the  button of the **Vectors** toolbar. Press **Insert** to create first node. Next nodes add automatically when moving mouse with pressing left button. Nodes add through the distance set in the general system’s parameters (see the “[General system’s parameters](#)” User Manual).



To add a node in a distance closer than specified, use the **Insert** key.



In classifier layer the streamline mode is used with linear (L) or polygonal (P) code type.

3.4.5. Fixation of Z

To perform vectorization on a constant elevation (for example, during contour lines creation) the system provides fixation of marker by Z mode.

To fix vectorization elevation place marker to necessary position and click the  button in the **Marker** window (**Alt+Z**).

3.4.6. Snapping mode

Snapping called marker movement mode, when it “sticks” to the different elements of the vector objects on the screen (to points, midpoints, lines, etc). The mode is used for precise spatial matching of created objects elements with elements of existing ones.

It is possible to snap created objects not only to objects located in active layer, but to all objects on opened vector layers, as well as to elements of the object being created.

For the work in *snapping* and *multi-snapping* modes (see below) the system provides the **Edit > Snapping** menu items, hotkeys and **Vectors toolbar** buttons (partially).

Snapping types and modes

The system supports two *types* of snapping:

- 2D – XY-plane marker coordinates match to coordinates of object elements, Z-height of marker is not changed;



2D snapping is used while creation an object coinciding with existing one only in XY plane. If, for example, it is necessary to add an extension to building with different height.

- 3D – XYZ marker coordinates match to coordinates of object elements;

Both snapping *types* provide several *modes*, defining an interaction of marker with particular elements of vector objects (see below).





The system also provides *multi-snapping* functionality, which allows for using several snapping modes at once, to generate unique combinations of active snapping options.

Work in snapping mode



For work in snapping mode *only* the hotkeys are used (see the “[Hotkeys](#)” User Manual).

Table 2. Work in snapping mode

Hotkeys and “Snapping” menu items	Function
 3D snapping to vertices (V)	when the mode was enabled with hotkey, marker moves to the vertex nearest to the marker position
 2D snapping to vertices (B)	when the mode was enabled with hotkey, marker moves to the vertex nearest to the marker position without changing marker’s height value
 3D snapping to lines (N)	when the mode was enabled with hotkey, marker moves to the point on vector object segment, closest to the marker position, with exact match with XYZ coordinates
 2D snapping to lines (M)	when the mode was enabled with hotkey, marker moves to the point on vector object segment, closest to the marker position, without changing marker’s height value

Work in multi-snapping mode

The *multi-snapping* mode allows for using several snapping modes at once, to generate unique combinations of active snapping options.

It is recommended to set snapping parameters before work with vector objects in multi-snapping mode.

To specify snapping settings, select **Service** › **Settings**. Set snapping parameters at the **Snapping** section of **Vectors** tab (see the “Settings of work with vector objects” chapter of the “[General system’s parameters](#)” User Manual).

Set the following parameters:

- **Detect radius** (in pixels) – if marker is placed from the object element at the distance of less than **Detect radius**, this element is highlighted by grey colour with no snapping (moving marker);



An element is highlighted in gray, if the default **Show tips** checkbox is not cleared in the **Settings (Service › Settings › Vectors)** window.

- **Snap radius** (in pixels) – if marker is placed from the object element at the distance of less than **Snap radius**, a marker snapped to this element. A label of snapping mode used appears near it;



A snapping label appears if the default **Show labels** checkbox is not cleared in the **Settings (Service › Settings › Vectors)** window.

- **Cache for snapping to coordinates** – is used during [Snapping to coordinates](#) and [Manual snapping to coordinates](#);

The **Separate 2D and 3D modes** checkbox allows to generate unique combinations of active snapping options (to points, midpoints, lines, coordinates, as well as perpendicular mode) separately for 2D and 3D snapping modes. The **Create common vertices on snap to lines mode** checkbox allows to add vertices in snapping mode both on marker and source line height.





In the 3D-snapping mode vertices are also becomes topological connected. When editing vector objects (e.g. when [cutting with a polyline](#)), the topological connectivity of objects is not disrupted.







For the work in *multi-snapping* mode the system provides the **Edit > Snapping** menu items, hotkeys and **Vectors toolbar** buttons.

To start working in multi-snapping mode make active one of two multi-snapping types:

Table 3. Brief description of the multi-snapping types and modes

Hotkeys and “Snapping” menu items	Function
 2D multi-snapping (2)	Marker moves to vector object elements (vertices, medians etc.), XY-plane marker coordinates match to coordinates of object elements, Z-height of marker is not changed;
 3D multi-snapping (3)	Marker moves to vector object elements (vertices, medians etc.), XYZ marker coordinates match to coordinates of object elements;

Make active at least one of following snapping modes:

 Snap to points (4)	marker snaps to vertices of vector objects. Label End appears near that nodes
 Snap to midpoints (5)	marker snaps to medians of vector objects. In case of detecting object segment at the distance of lower than Detect radius , its median is highlighted by small grey circle symbol. Label Midpoint appears near that medians
 Snap to lines (6)	marker snaps to segments of vector objects. Label Nearest appears near segment point closest to the marker position
 Perpendicular snap (7)	allows to <i>edit</i> vector objects by moving their vertices in directions parallel or perpendicular to adjacent segments, as well as to move these vertices to the segments of the edited object (or the segments of neighboring objects) towards the perpendicular to these segments
 Snap to coordinates (8)	allows to <i>create</i> polylines/polygons orthogonal to the basic or additional coordinate system, as well as accurately orient drawing objects regarding vertices of existed vector objects



Menu item **Select a segment for a snapping (Ctrl+Space)** is used during [snapping to the selected segment's prolongation or parallel](#).



While activating a snapping mode with a hotkey, a highlighting of corresponding object element or marker move to element position take place automatically if the element is at the distance less than **Detect radius** or **Snap radius** respectively.







In snapping mode there is a possibility to draw a part of the created object over existing one (see [Section 11.7](#)).

Perpendicular snapping



The perpendicular snapping mode is used *only for editing* already created vector objects. To *create* orthogonal vector objects, use [snap to coordinates](#) or [orthogonal mode](#).

When the perpendicular snapping mode is activated, the system allows to edit vector objects by moving their vertices in directions parallel or perpendicular to adjacent segments:

1. Activate **Select vertices when marker moves over them** and **Move marker to selected vertex** modes by setting the appropriate checkboxes in the **Settings (Service > Settings > Vectors)** window, or click  and  buttons in the **Vectors additional toolbar**.
2. Make active one of two multi-snapping types –  **2D multi-snapping** or  **3D multi-snapping**;
3. Make active  **Perpendicular snap mode**;
4. Press and hold the **Ctrl** key;
5. Holding the **Ctrl** key move the *mouse cursor* to the needed vertice and press and hold the **left mouse button**. The vertice and the adjacent segments would be highlighted by white colour;

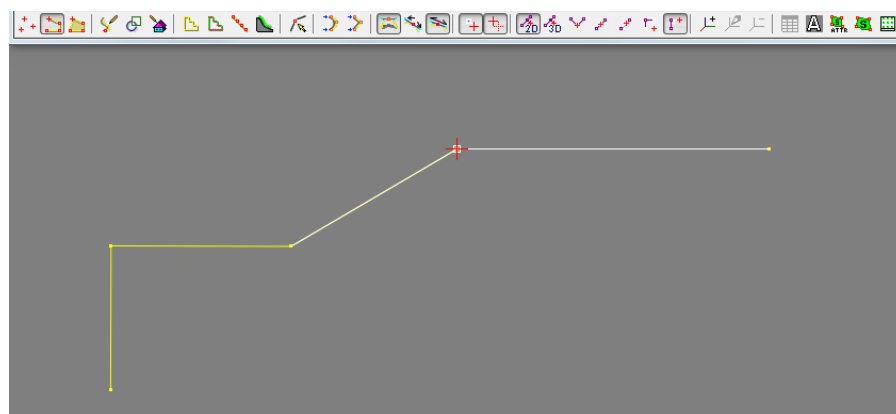

Fig. 8. The vertice and the adjacent segments are highlighted by white colour

- 6. Holding the **Ctrl** key and **left mouse button** move the marker to the different directions. Creation of guides is indicated by Perpendicular and Parallel labels in the vicinity of a vertex, respectively.

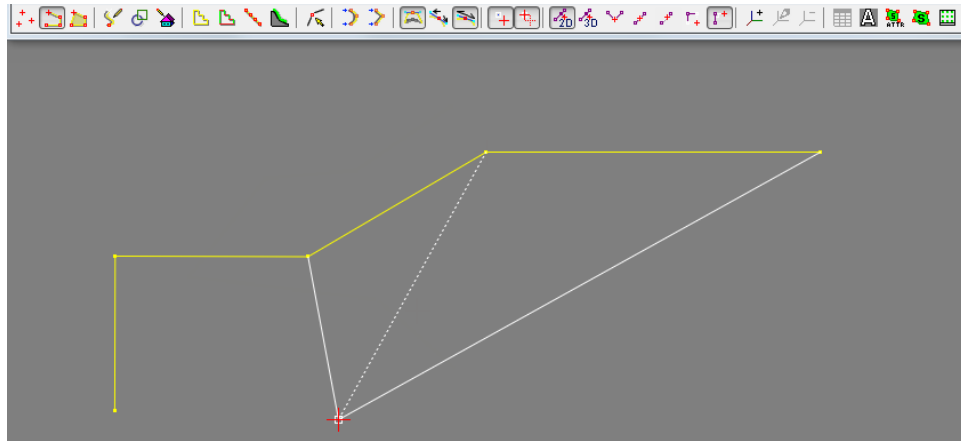

Fig. 9. Moving the vector object vertex to the arbitrary direction

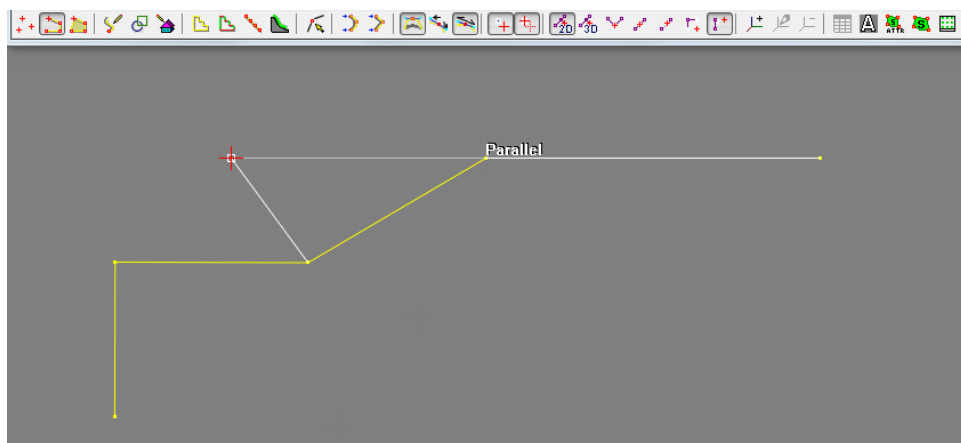

Fig. 10. Moving the vector object vertex parallel to the adjacent segment

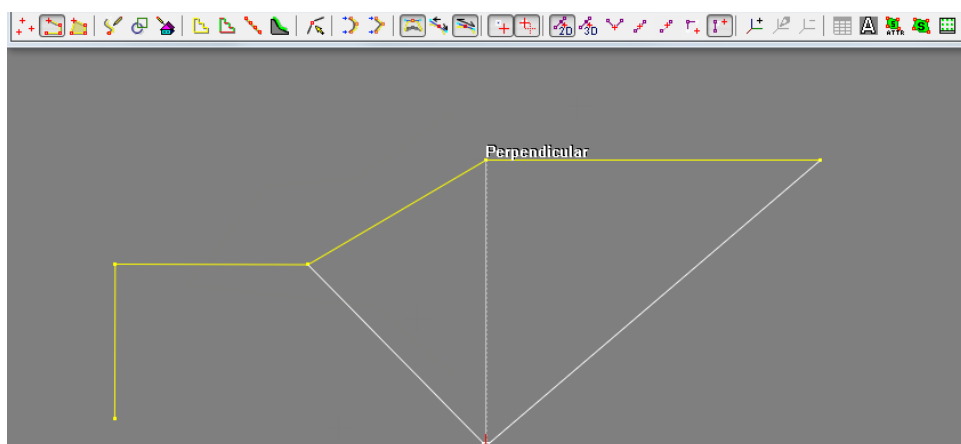







Fig. 11. Moving the vector object vertex perpendicular to the adjacent segment

When the perpendicular snapping mode is activated, the system also allows to move vertices of the edited object to the segments of this object (or the segments of neighboring objects) towards the perpendicular to these segments.

When moving an object's vertex to neighboring vector objects (or the edited object segments), "snap points" are created (indicated by a small gray square and a Perpendicular label) located at the intersection of segments and the *perpendicular* (gray dashed line) originating from the location of the moved vertex:

Perform the following:

1. Activate **Select vertices when marker moves over them** and **Move marker to selected vertex** modes by setting the appropriate checkboxes in the **Settings (Service > Settings > Vectors)** window, or click  and  buttons in the **Vectors additional toolbar**.
2. Make active one of two multi-snapping types –  **2D multi-snapping** or  **3D multi-snapping**;
3. Make active  **Perpendicular snap** mode;
4. Press and hold the **Ctrl** key;
5. Holding the **Ctrl** key move the *mouse cursor* to the needed vertice and press and hold the **left mouse button**.

The vertice and the adjacent segments would be highlighted by white colour.

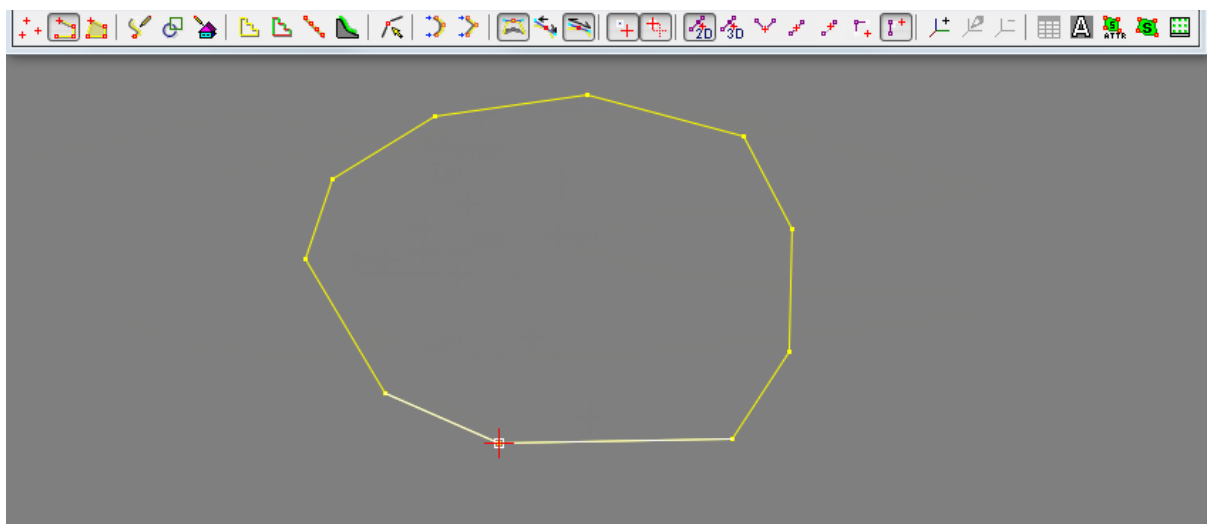

Fig. 12. The vertice and the adjacent segments are highlighted by white colour

Perform one of the following:

- [optional] Holding the **Ctrl** key and **left mouse button** move the marker to the direction of the edited object segments;

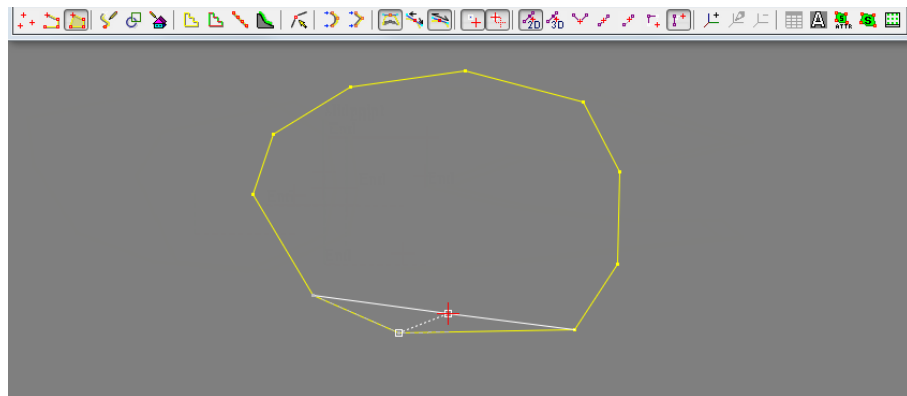

Fig. 13. Moving the vector object vertex to the arbitrary direction

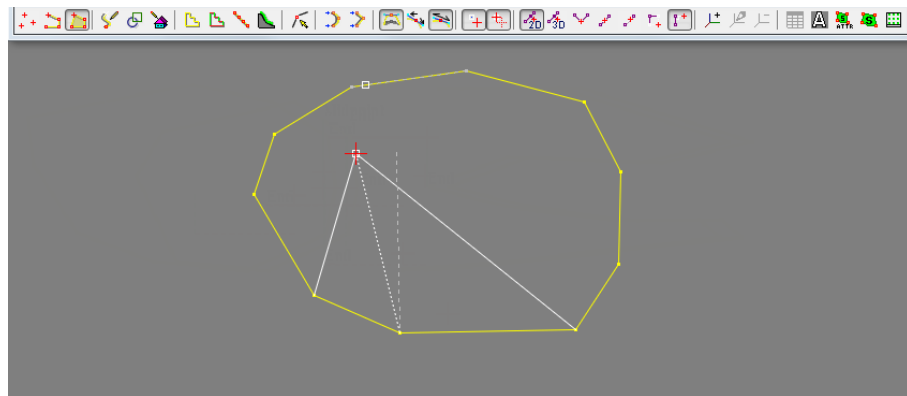

Fig. 14. Moving the vector object vertex to the arbitrary direction (the “snap point” is created – the marker is in **Detect radius**)

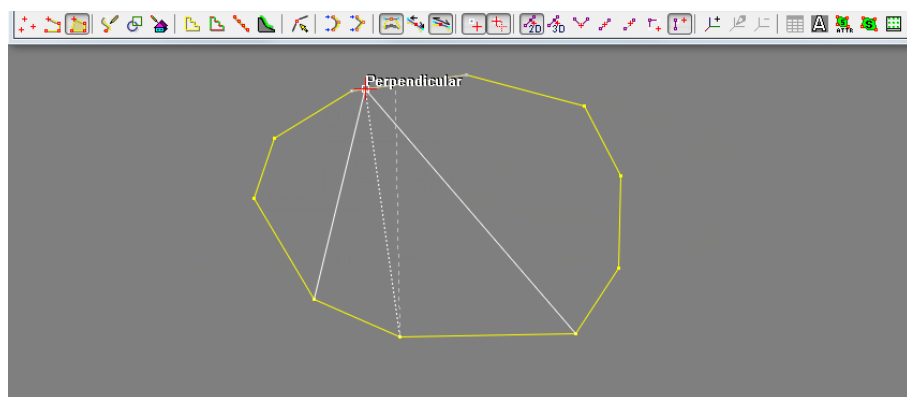

Fig. 15. The object's vertex snapping to the same object segment in the direction perpendicular to the segment

- [optional] Holding the **Ctrl** key and **left mouse button** move the marker to the direction of the neighboring vector objects segments;

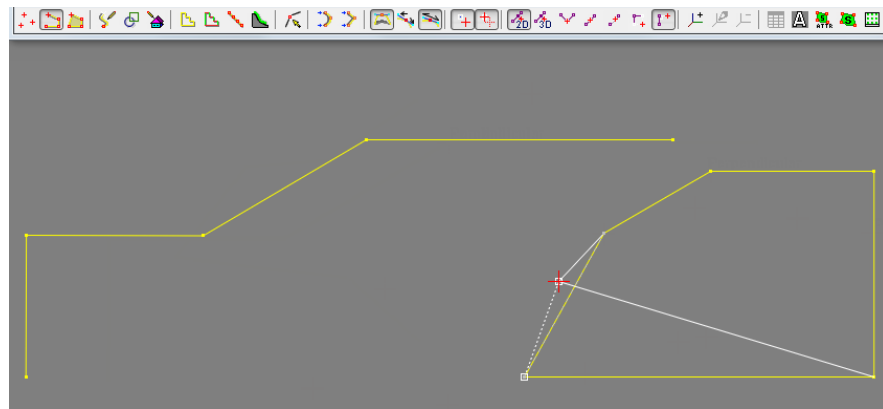

Fig. 16. Moving the vector object vertex to the arbitrary direction

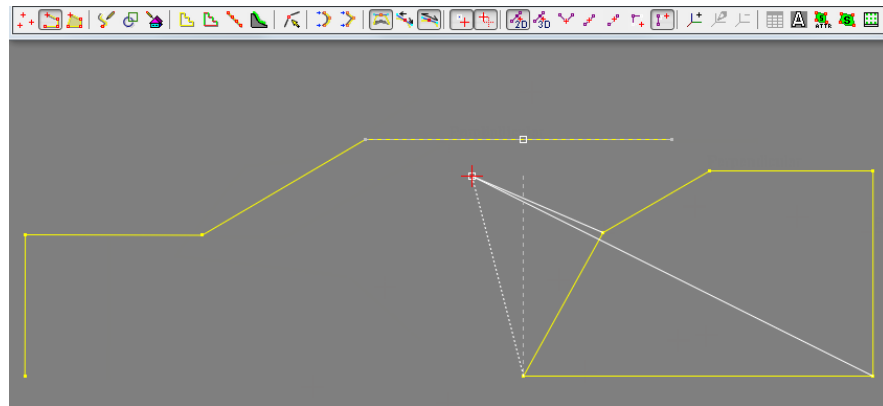

Fig. 17. Moving the vector object vertex to the arbitrary direction (the “snap point” is created – the marker is in **Detect radius**)

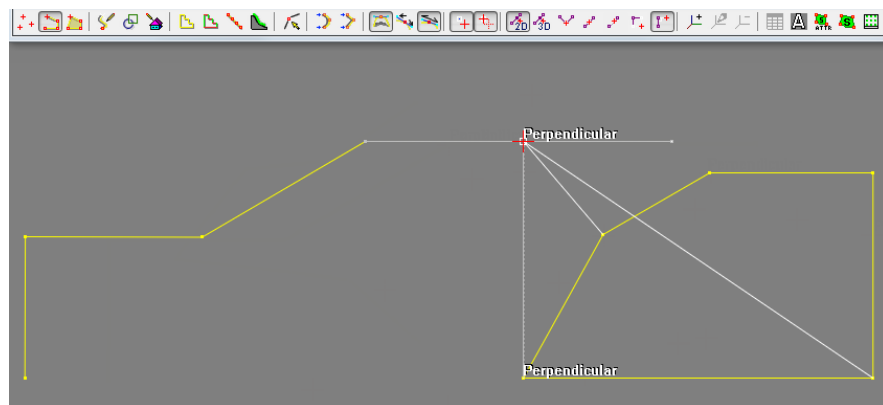

Fig. 18. The object's vertex snapping to the neighboring object segment in the direction perpendicular to the segment

Snap to coordinates

If **Snap to coordinates** mode is enabled, the system allows to build and edit polylines/polygons orthogonal to the basic or [additional coordinate system](#) as well as accurately orient drawing objects regarding vertices of existed vector objects.

- While creating polylines/polygons starting from the first vertice, a marker snaps to red and green dash line *guides*, outgoing from the vertices of the created object and co-directed with axes of basic or additional coordinate systems. Red guide is co-directed with X axis, green guide is co-directed with Y axis.

Guide is shown as a solid line if the marker was placed near the guide (at the distance shorter than **Snap radius**), was snapped to the guide, and drawing segment of polyline/polygon should be co-directed with corresponding axis of coordinate system. In neighbourhood of vertices from which guides outgo labels End appear.



Dashed *guides* are displayed only if default **Show tips** checkbox is not cleared in the **Settings (Service > Settings > Vectors)** window and if the distance between the previously created object's vertices and the marker position does not exceed the **Detect radius**.

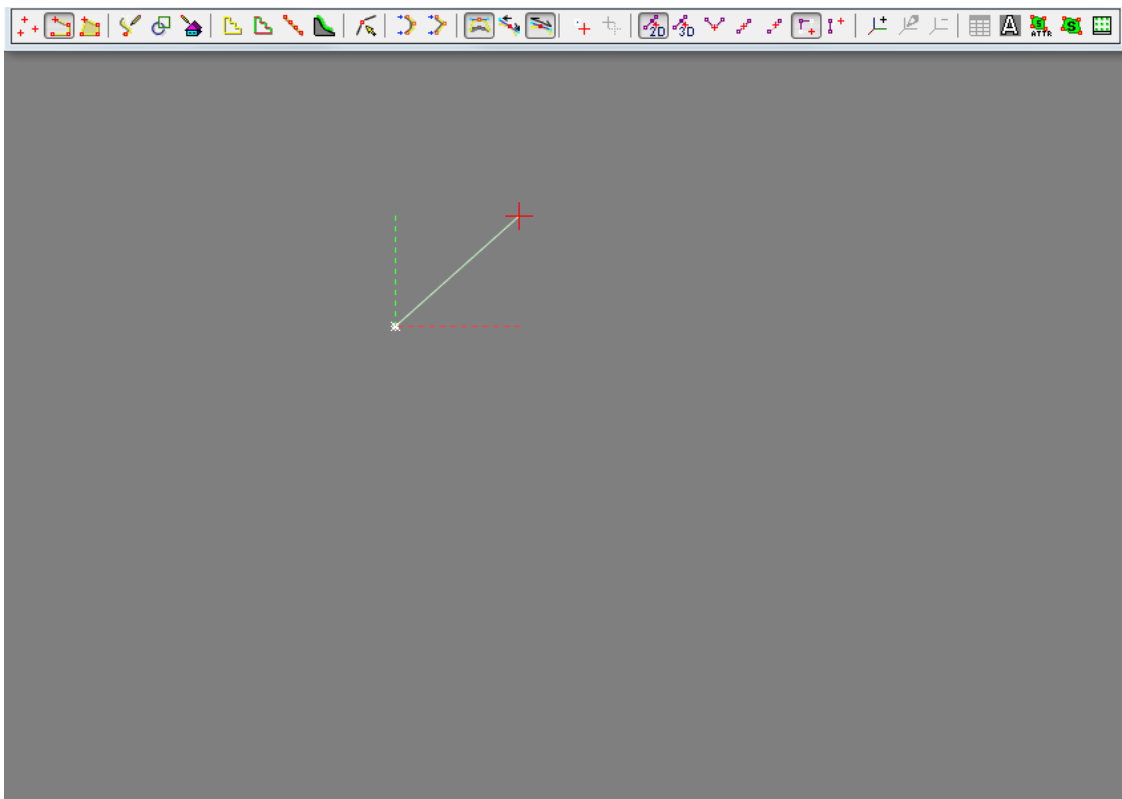

Fig. 19. The beginning of the vector object creation in **Snap to coordinates** mode.

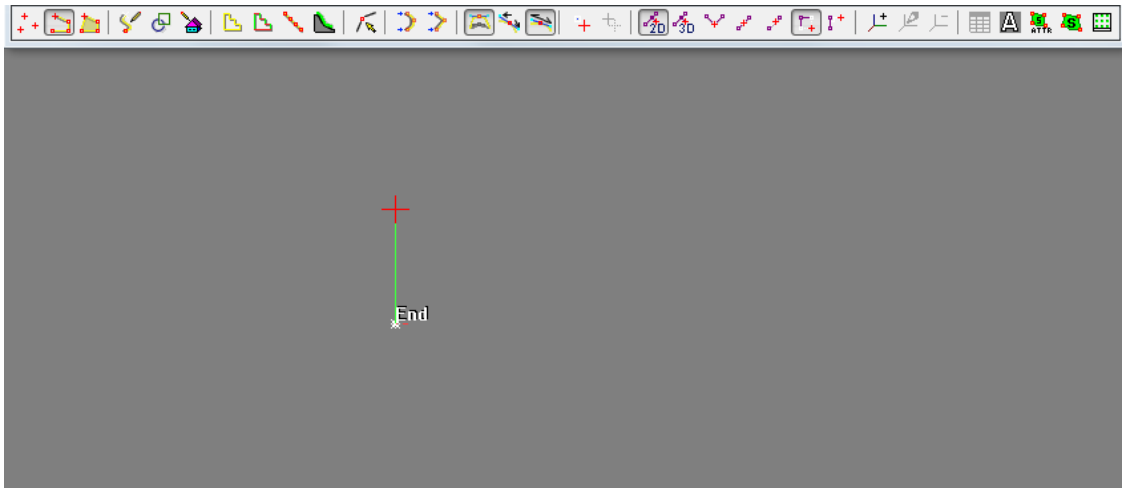

Fig. 20. Creation of the segment, co-directed with Y axis.

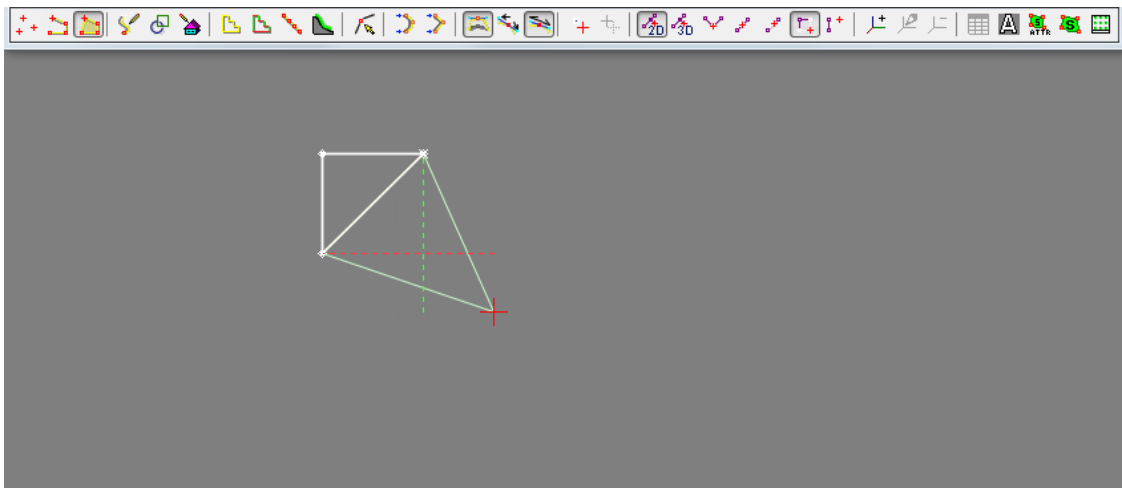

Fig. 21. Guides, outgoing from 2 previous created vertices

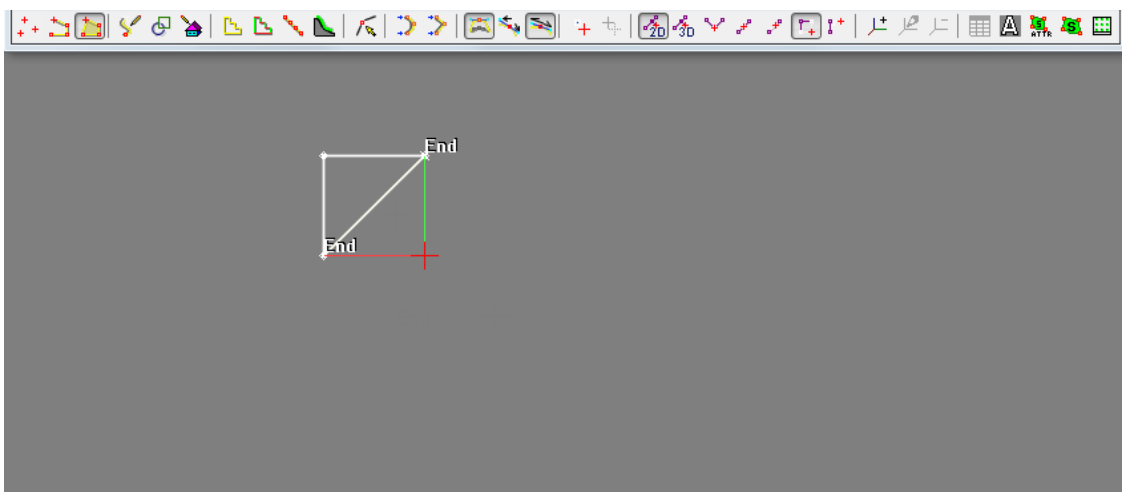

Fig. 22. Guides, outgoing from 2 previous created vertices

- If **Snap to points / Snap to midpoints** mode is enabled as well, while drawing polyline/polygon in the neighborhood of existed vector objects, the *guides* outgoing from the vertices (medians) of existed vector objects are also built.

To have guides from the vertices (medians) of an existing object (in the process of a new object creation), it is needed first snap to every needed vertice (median) of this object (see **Cache for snapping to coordinates** parameter above).

While snapping marker to intersection of guides, guides are shown like solid lines. In neighbourhood of vertices from which guides outgo labels End appear.



The system provides for memorizing the fixed number of selected vertices of existing objects to snap to coordinates which is determined by the **Cache for snapping to coordinates** option that can be set in the **Settings (Service > Settings > Vectors)** window.

Maximum value for **Cache for snapping to coordinates** is 100. If the value of **Cache for snapping to coordinates** is equal to 0, the selection of vector object's vertices (by snapping to them) will not result in appeared guides, and it will not be possible to set the marker on their intersection.



Snapping functions are active not only when creating new objects but when editing positions of the existing object's vertices.



In default while **Snap to coordinates** mode is enabled guides outgo just from the vertices of existed objects. If **Snap to medians** mode is enabled as well, additional guides outgoing from segment medians are built.

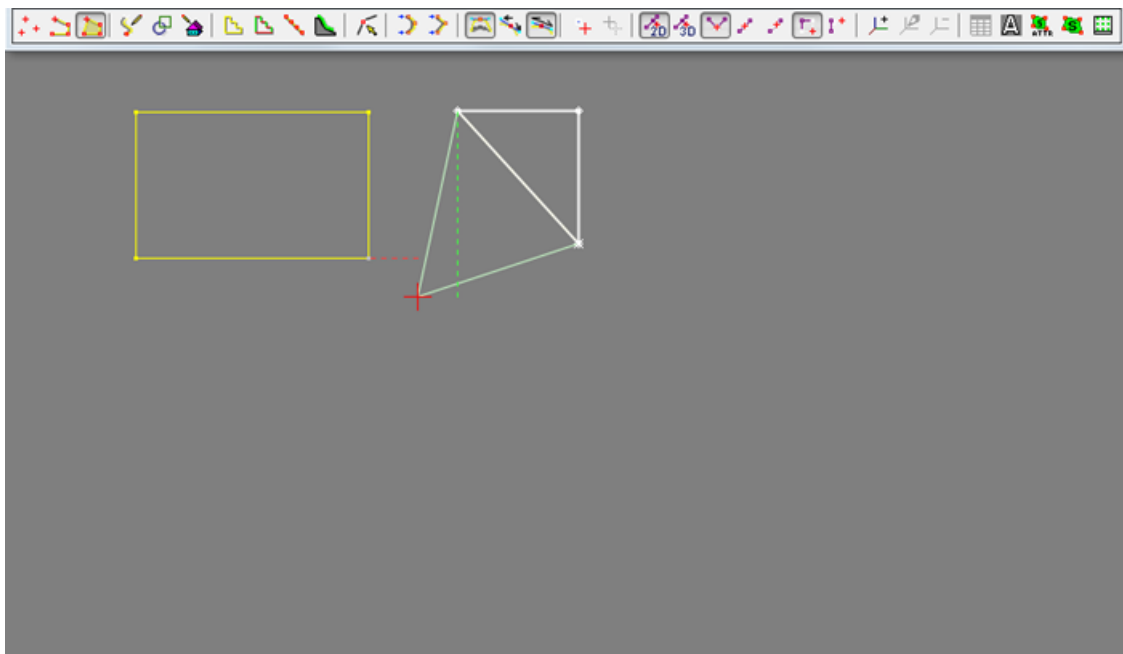

Fig. 23. Guides originating both from the vertex of the created object and the neighboring object's vertex (snapping to the vertex of the left object was performed previously)

“Manual” snapping to coordinates

With enabled snapping to coordinates mode, the system allows to create vertices of vector objects in so called “manual snapping to coordinates” mode at the points of intersection of the preset direction and the perpendicular from it to *guides* originating from the vertices of the created object, as well as from the vertices of the existing objects (if **Snap to points** is additionally activated) and the medians of object’s segments (if **Snap to midpoints** is additionally activated).

For manual snapping, perform the following:

1. Create at least one polygon/polyline vertex;
2. Press and hold the **left mouse button** and move the marker, thus setting the direction;

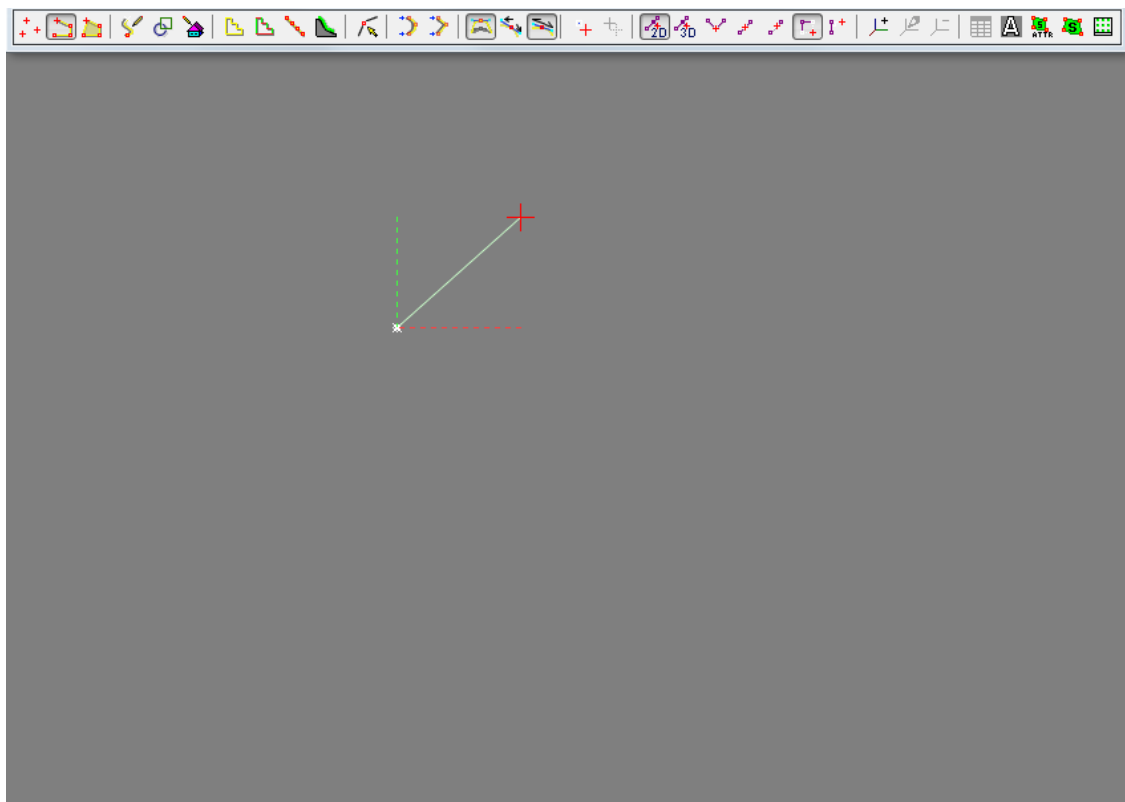

Fig. 24. Start of an object creation in the manual snapping to coordinates mode (when moving the marker, press the **left mouse button**)

3. Holding the **left mouse button**, press **Shift**;
4. Holding the **left mouse button** and the **Shift** key, keep moving the marker. The following will be created:

- A solid grey *guide* that prolongs the direction set in paragraph 2;
- A dashed grey *perpendicular* from this *guide* to the dashed red and green *guides* co-directed with the axes of main or additional coordinate systems which originate from the vertices of the created object (and from the vertices of the existing objects, their segments, and medians of their segments, depending on the snapping modes that are active)
- The point of intersection marking the place of the next vertex creation denoted with a small grey x-type cross.

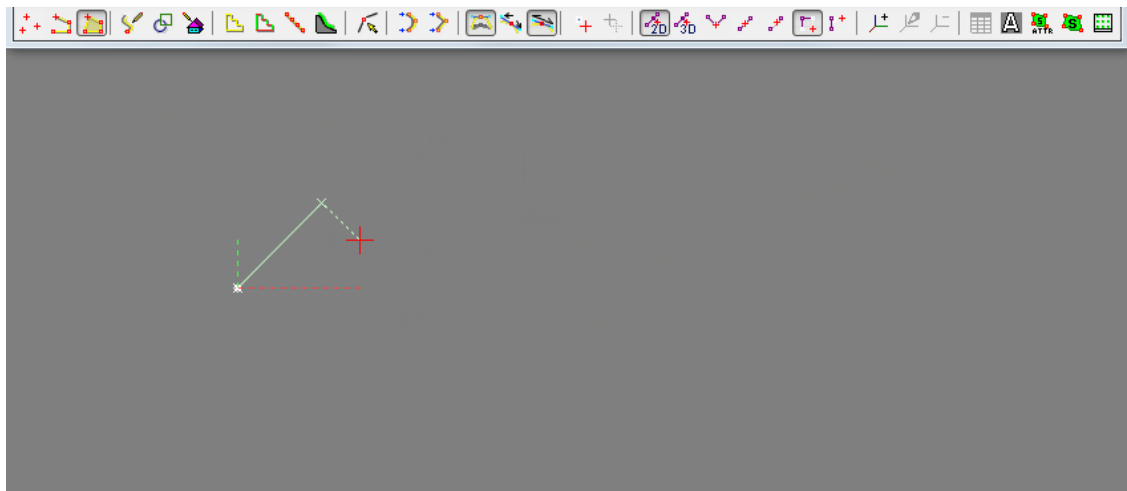

Fig. 25. Moving the point of the next vertex creation strictly in the direction set in paragraph 2 (both the **left mouse button** and **Shift** button are pressed)

5. Move the marker to the desired position, release the **left mouse button** and the **Shift** button, press the **Insert** button to create a new vertex at the intersection point denoted with a small grey x-type cross.

If **Snap to points / Snap to midpoints** mode is enabled as well, while drawing polyline/polygon in the neighborhood of existed vector objects, the *guides* outgoing from the vertices (medians) of existed vector objects are also built.

To have guides from the vertices (medians) of an existing object (in the process of a new object creation), you should first snap to every needed vertex (median) of this object (see **Cache for snapping to coordinates** parameter above).



The system provides for memorizing the fixed number of selected vertices of existing objects to snap to coordinates which is determined by the **Cache for snapping to coordinates** option that can be set in the **Settings (Service > Settings > Vectors)** window.

Maximum value for **Cache for snapping to coordinates** is 100. If the value of **Cache for snapping to coordinates** is equal to 0, the selection of vector object's vertices (by snapping to them) will not result in appeared guides, and it will not be possible to set the marker on their intersection.

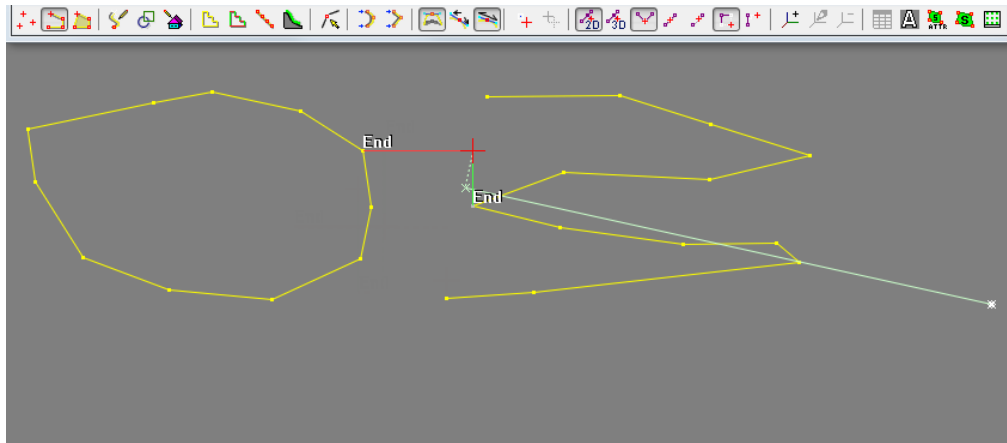

Fig. 26. Working in the manual snapping to coordinates mode (**Snap to points** is added)

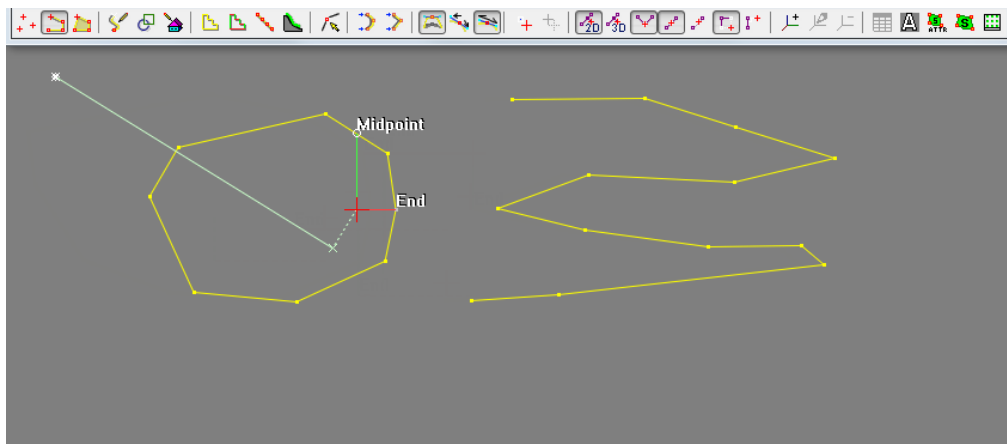

Fig. 27. Working in the manual snapping to coordinates mode (**Snap to points** and **Snap to midpoints** are added)

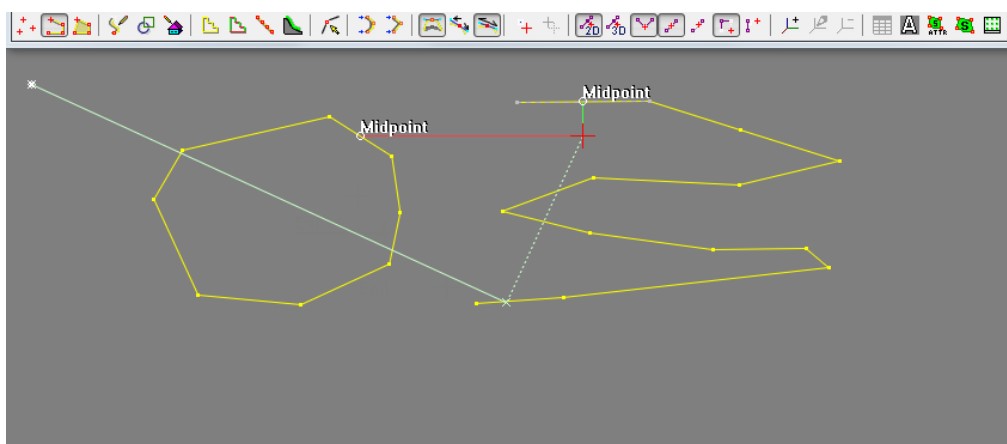

Fig. 28. Working in the manual snapping to coordinates mode (**Snap to points** and **Snap to midpoints** are added)

Snapping to the selected segment's prolongation or parallel

The system allows to snap to *guides* which are prolongations (or parallels) of the selected segments of existing vector objects.

To do this, perform the following:

1. Load or create a vector layer with polygons and/or polylines;
2. Activate the following modes of 2D or 3D mult snapping:
 - **Perpendicular snap;**
 - **Snap to lines.**
3. Start the creation of a new vector object entering the first vertex;
4. Move the marker to the vicinity of the desired segment of an existing object (the segment will be *highlighted* by grey colour).

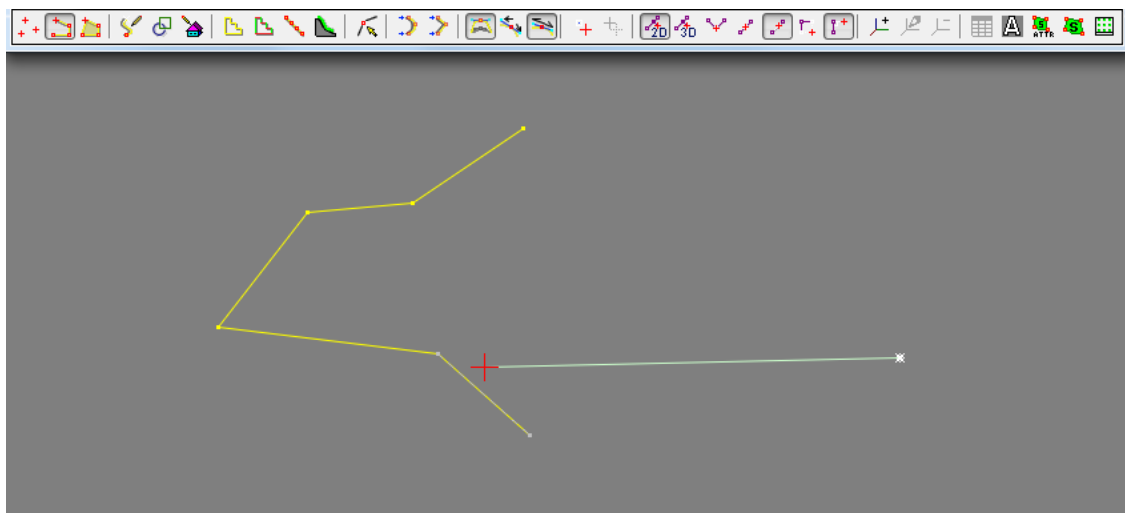

Fig. 29. The marker moved to the vicinity of the segment of an existing object, the segment is highlighted

5. Choose **Edit > Snapping > Select a segment for a snapping** (or use **Ctrl+Space** hotkeys) to *select* this segment;



Press **Esc** to disable this selection.

6. Perform one of the following actions:

- [optional] move the marker to the vicinity of the new vector object first vertex. A *guide* is created which is the parallel of the selected segment of the existing object. Use this *guide* to create a segment which is the parallel of the selected segment of the existing object;

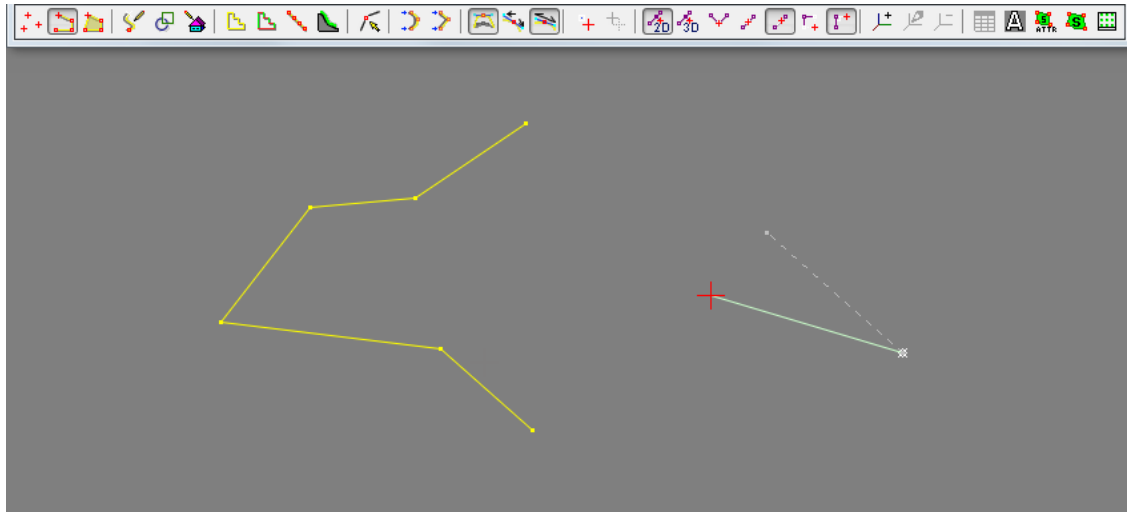

Fig. 30. A guide which is the parallel of the selected segment of the existing object

- [optional] move the marker to the vicinity of the desired segment of an existing object once more. A *guide* is created which is the prolongation of the selected segment of the existing object. The point where the guide and the created segment are decussate is indicated by a small gray square;

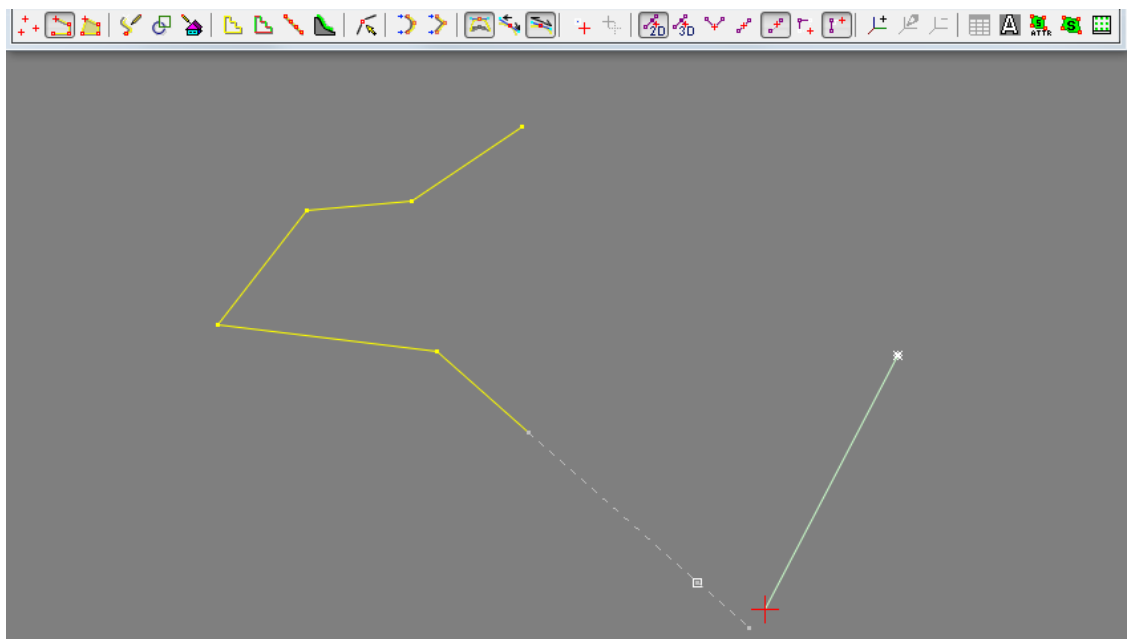

Fig. 31. The guide that is the prolongation of the selected segment of the existing object

Perform one of the following:

- [optional] To create a vertex of a new object at an arbitrary point of a *guide*, move the marker to the *guide* of interest (in the vicinity of the marker a label Nearest appears). Enter a new vertex.

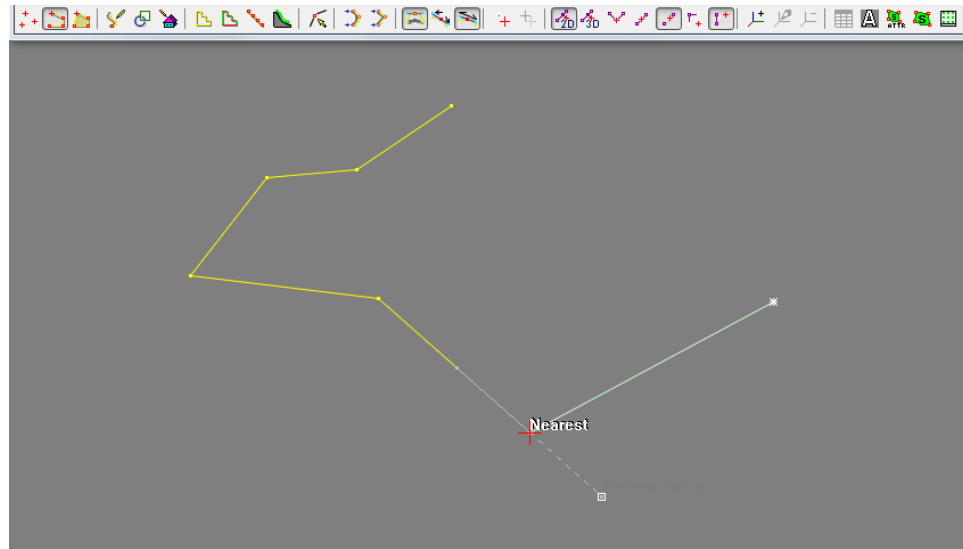

Fig. 32. Creating a new object vertex at an arbitrary point of the guide

- [optional] To create a new object segment perpendicular to a *guide*, move the marker in the final point of the *guide* (in the vicinity of the marker, the label Perpendicular appears). Enter a new vertex.

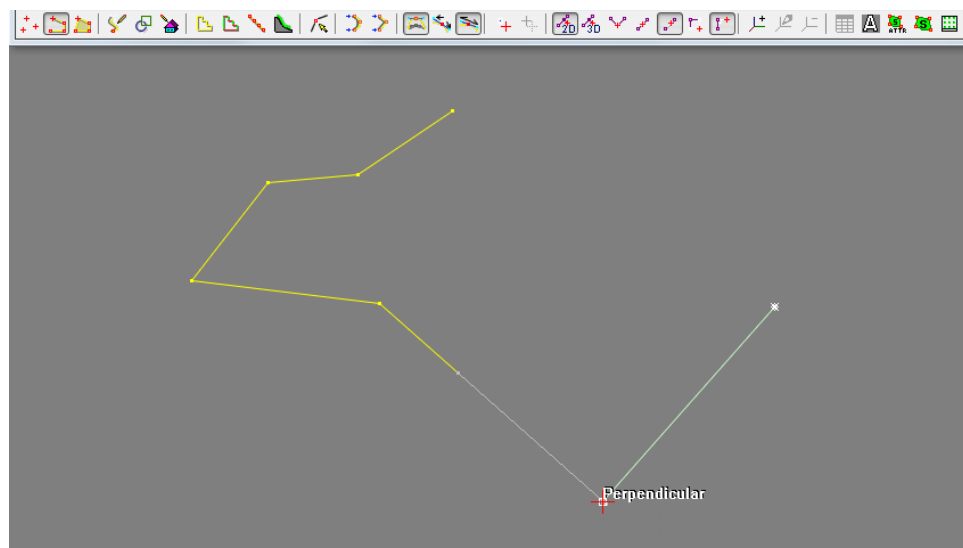

Fig. 33. Creating a segment perpendicular to the guide

3.5. Creation of “stereo quality” map

The system allows to estimate stereo quality for images block that contains stereopairs. The principle of building a stereo “quality maps” is as follows. Stereopair with the best stereo quality is automatically formed from images. This stereopair is then used by the system for evaluation of other characteristics of other stereopair, as well as their quality score.

Stereo “quality map” is a grid which nodes are colored in images overlap areas according to assigned score.



To create stereo “quality map” it is necessary to complete block adjustment step (see the “[Block adjustment](#)” User Manual).

To create stereo “quality map” perform the following actions:

1. Select **Grid › Properties** to create a grid. After that the **Grid** layer creates in the Manager and the **Grid properties** window opens.

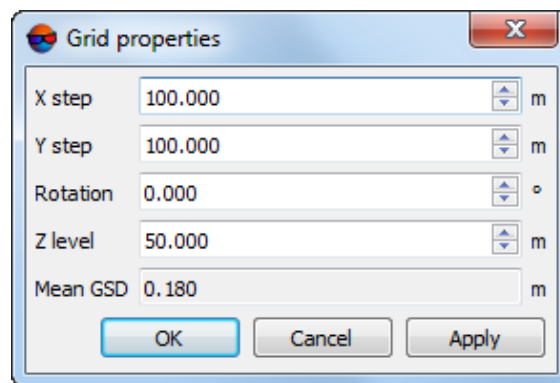

Fig. 34. Regular grid parameters

2. Set a grid step by X and Y in the **X step** and **Y step** fields.



The less the grid step, the more time is needed for creating the map of stereo quality.

3. Click OK. The grid is displayed in 2D-window on the images block as a set of nodes of the same colour according to specified step by X and Y.
4. Place marker to overlap area on any stereopair of images block in 2D-window.
5. Choose **Vectors › Create stereo quality map**. The **Select stereopair** window opens.

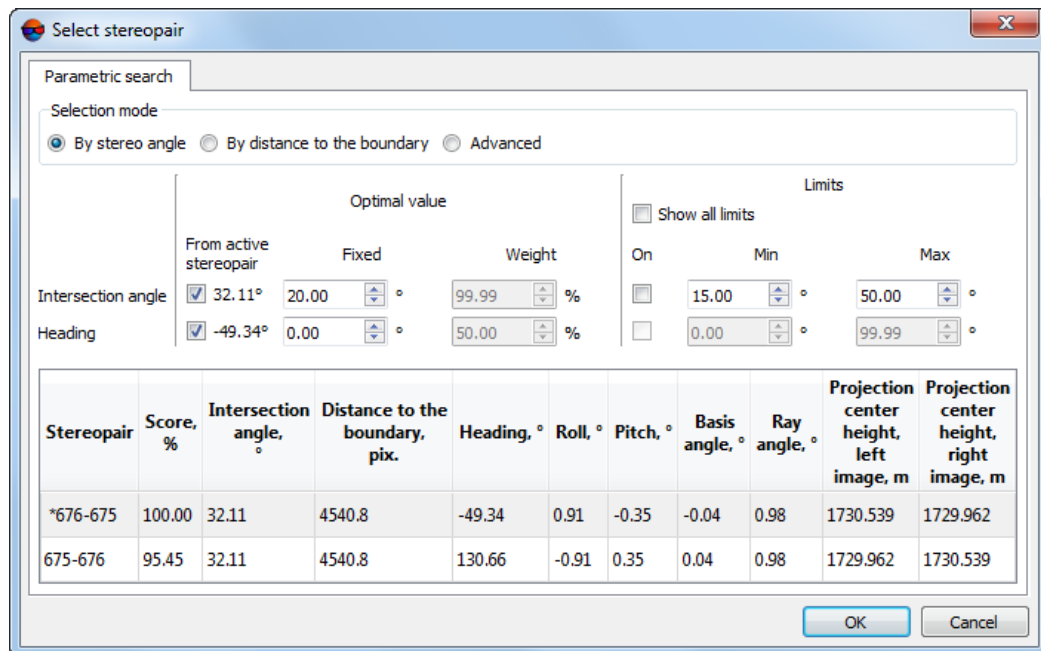

Fig. 35. Parametric method of stereopair selection

Stereopair table displays a list of all stereopairs found in marker position. The system selects automatically an optimal stereopair – block stereopair with the best stereoscopic effect. This stereopair is assigned the highest rating.

For each stereopair in the table the following parameters values are shown:

- **Score, %** – a score of stereo quality for block stereopairs;
- **Intersection angle, degrees** - an angle between photographing beams at the current terrain point (in marker position);
- **Distance to the boundary, pix.** - the shortest distance from the current marker position to the stereopair boundary;
- **Heading, degree.** - rotation angle of airframe in horizontal plane measured from the north direction (countdown of positive angles counter-clockwise when viewed from above);
- **Roll, degree.** - rotation angle (roll angle) of aircraft in relation to roll axis;
- **Pitch, degree.** - rotation angle of aircraft to main transverse axis of inertia or angle between aircraft roll axis and horizontal plane;
- **Basis angle, degree.** - angle between photographic image base and coordinate system plane;
- **Ray angle, degree.** - angle between ray and coordinate system plane;

- **Projection center height, left image, m** - projection center height for left image, in meters;
 - **Projection center height, right image, m** - projection center height for right image, in meters;
6. [optional] To select an optimal stereopair manually perform the following actions:



It is not recommended to select parameters manually for VisionMap A3 projects.

1. In the **Selection mode** section specify one of the following ways of optimal stereopair selection:



Mode of active stereopair selection and configuring of selection parameters leads to recalculating of stereo quality score of all stereopairs in the table.

- **By stereo angle** - allows to select an active stereopair by optimal or specified stereo angle;
 - **By distance to the boundary** - allows to select an active stereopair by distance from current point in marker's position to stereopair's boundary;
 - **Advanced** - allows to find an active stereopair which features satisfy extended set of specified parameters.
2. [optional] Specify optimal parameters values for selected mode in the **Optimal value** section. To configure parameters use calculated value from active stereopair or specify fixed value (with indication of weight percentage for the advanced mode).
 3. [optional] Define a range of acceptable values of specified parameters in the **Limits** section. The system suggests by default to specify limits (minimal and maximal values) for stereo angle. To define a range of acceptable values of other parameters set the **Show all limits** checkbox on.
7. Click OK. After that the system generates stereo quality map in 2D-window and the new *Stereo quality map* layer appears in the *Manager*.

The layer is a grid, which each node is assigned the following [attributes](#) values, corresponding to selected parameters of the table:

- **quality** – quality **score** assigned to the stereo, depending on which a node in images overlap areas is colored;
- **st_ang** – **angle of stereo** between photographing beams at the current terrain point (in marker position), corresponds to the table parameter;

- heading – **heading**, rotation angle of airframe in horizontal plane measured from the north direction (countdown of positive angles counter-clockwise when viewed from above);
- roll – **Roll**, degrees;
- pitch – **Pitch**, degrees;
- basis_roll – **Basis roll**, degrees;
- nadir_ang – **Ray angle**, degrees;
- bounds_dist_pix – **Distance to boundary**, pix;
- overlap_pix – overlap value, pix;
- [for central projection images only] z_l , z_r – **projection center elevation** for the left and right image, in meters;
- code_im_l, code_im_r – codes of left and right images, that compose a stereopair, according to assigned code in the **Catalogue of exterior orientation parameters** (see the “[Aerial triangulation](#)” User Guide).

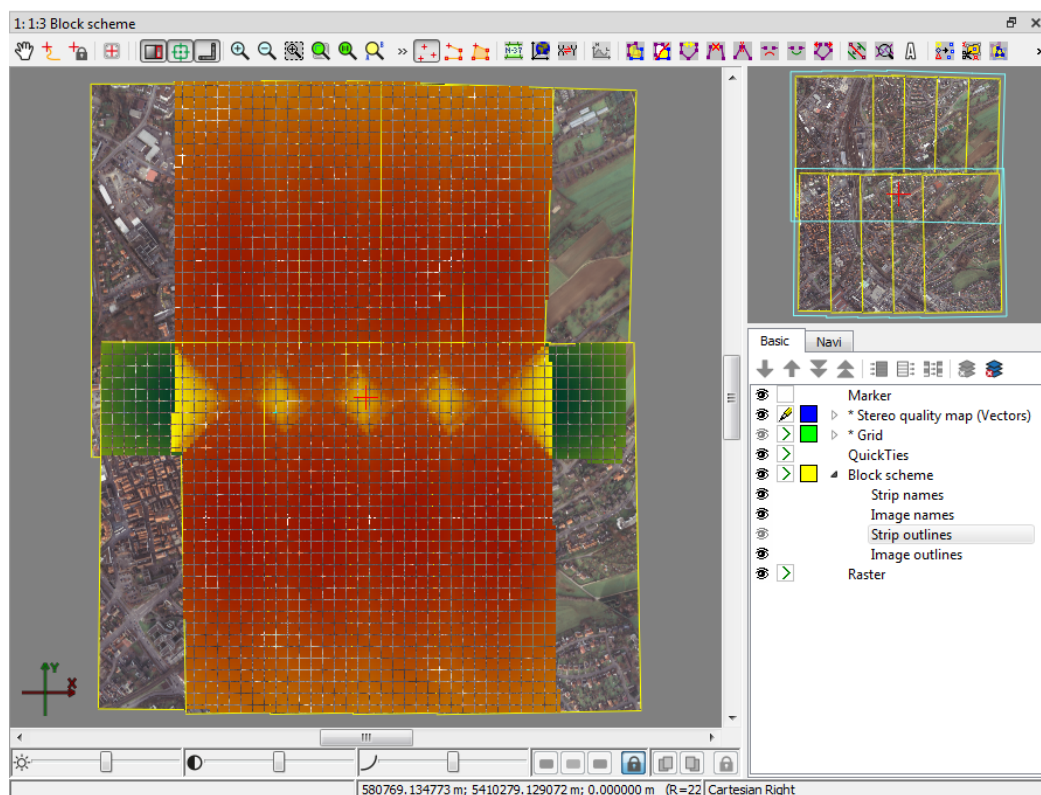

Fig. 36. Stereo quality map

To evaluate intersection angles in the images of the project, perform the following:

1. Create a “stereo quality” map for the block of images;
2. Change “stereo quality” map coloring according to the `st_ang` attribute values (**Vectors** › **Attributes** › **Color by attribute value**, see [Section 7.5.4](#));
3. To obtain information on the `st_ang` attribute value for the selected stereo quality map node, select the appropriate stereo quality map node and choose **Window** › **Objects attributes**.

3.6. Measurements on images

The system provides possibility to perform measurements on images.

To go to measurements mode use the **Measurements** window.

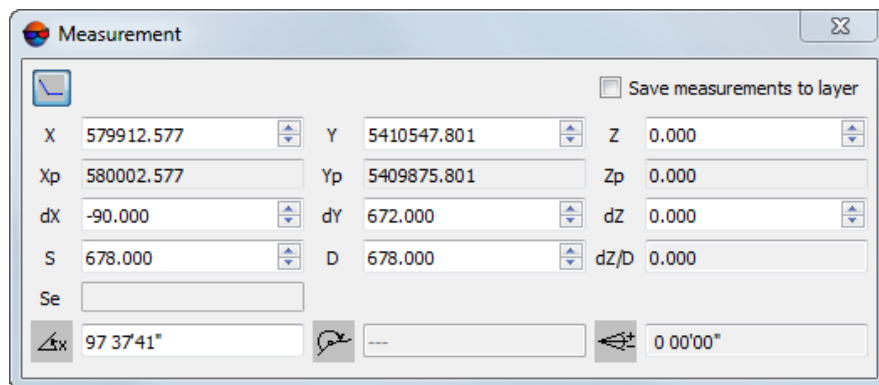

Fig. 37. The Measurements window

The window contains fields with marker coordinates values:

- X – marker X geodetic coordinate;
- Y – marker Y geodetic coordinate;
- Z – marker Z geodetic coordinate;
- X_p – marker X_p geodetic coordinate;
- Y_p – marker Y_p geodetic coordinate;
- Z_p – marker Z_p geodetic coordinate;
- dX – current segment incrementation by X ;
- dY – current segment incrementation by Y ;

- dZ – current segment incrementation by Z;

Besides, the **Measurements** window contains fields with values of the following parameters of segment:

- S – a length of segment (on the flat surface);
- Se – a length of *geodesic* curve on the surface of the ellipsoid (from the current coordinate system);



If the project coordinate system is *Cartesian* or *Local Curved*, this field remains empty.

- D – a length of horizontal distance (projection on a plane) of segment by Z;
- dZ/D – a value of segment slope (Z increment ratio to the horizontal distance);
- – direction of current segment relative to X axis;
- – direction of current segment relative to previous one;
- – vertical angle of current segment.

Do the following actions to perform measurements:

1. Choose **Window > Measurements window (Ctrl+Alt+D)** or click the  button of the main toolbar to turn on the measurements mode. The *Marker* layer becomes active and the **Measurements** window opens.

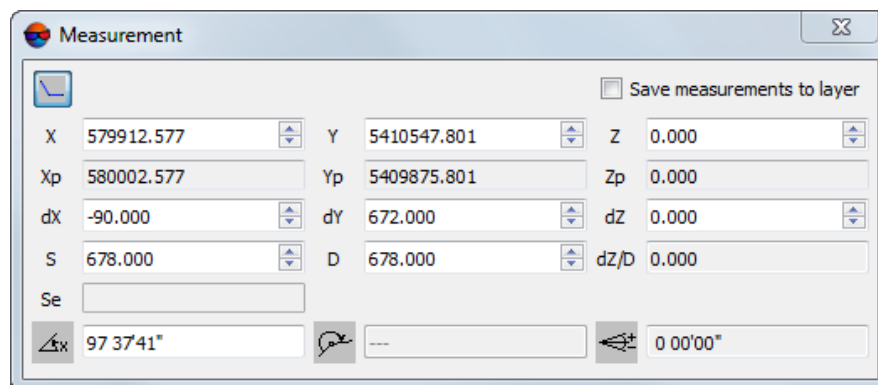

Fig. 38. The Measurements window

2. [optional] To save measurements to separate layer as vectors set the **Save measurements to layer** checkbox.



The layer with measurements is used for example as error vectors to convert vector objects (see [Section 10.1.4](#)).

3. Place marker to start point of measurement and press **Insert**.



During measuring the system creates temporary line (“rubber line”), that disappears after exit from measurements mode. To start temporary line creation click the  button.

4. Use the **Page Up** and **Page Down** hotkeys or rotate mouse wheel to set marker by Z.

5. Place marker to next point of measurement and press **Insert**. Parameters of created segment are displayed in the **Measurements** window.



Measurements are performed between current marker position and the last point where the **Insert** key was pressed.



The system provides possibility to input using keyboard marker geodetic coordinates and segment parameters to fields of the **Measurements** window. Marker moves to a point with specified coordinates and segment parameters after pressing the **Enter** key.

6. To complete measurements, close the **Measurements** window.



To leave the *Marker* layer active, close the **Measurements** window holding pressed **Ctrl** key.



The system provides possibility to make measurements both in 2D-windows during stereo vectorization, and in the **Points measurement**.

4. Vector layer creation

There are two vector layer types supported by the program:

- *vector layer without classifier* – is a vector objects layer without thematic classification;
 - [co-editing vector layer without classifier](#).
- *vector layer with classifier* – is a vector objects layer assigned to a classifier;

To create a vector layer without classifier select **Vectors** › **Create layer**. After that the *Vector* layer is created in the Manager and it has a serial number (starting from the second).

To create a co-editable vector layer, first create a vector layer without a classifier. Choose **Vectors** › **Save as**. In the window that opens, choose **Co-editable vector objects (*.cx-data)** in the appropriate drop-down list. Set the name and path to save a layer in the active profile resources and click **Save**.



PHOTOMOD Geomosaic program primarily creates vector layers available for collaborative editing, with automatic creation of so-called *cutlines* (special topologically connected vector

polygons, see “Cutlines creation” in the “[Orthophotomaps creation](#)” User Manual and the recommendations in [Section 16](#)).

To create a vector layer with classifier select **Vectors > Create layer with classifier**. After that the *Vector* layer is created in the Manager and it has a serial number (starting from the second) and the **Classifier** window opens.

4.1. Vector layer display settings

It is possible to adjust color, symbols and symbol size of objects in the *vector layer without classifier*, (and also for the *pre-regions*, *points* and *contour lines* layers).

To change colors and symbols of objects perform the following:

1. Double-click on layer objects color button () in a *Manager layer*. The **Raster layer parameters** window opens.

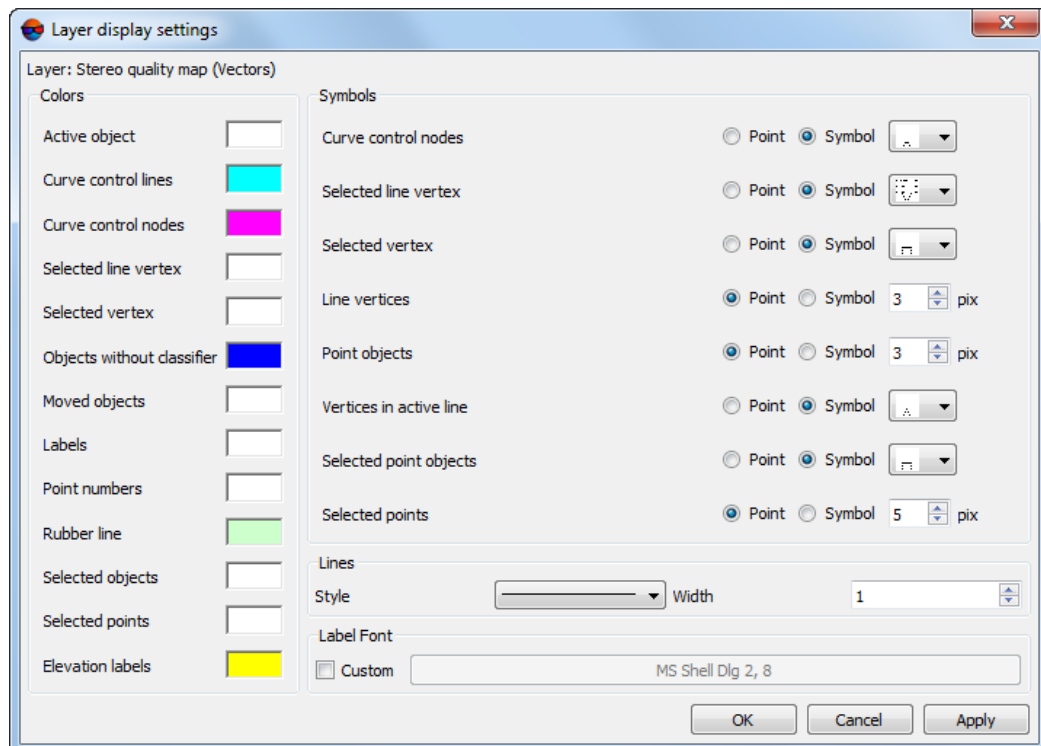

Fig. 39. Raster layer parameters

2. Double-click on the object’s color in the **Colors** section and choose necessary color from standard color palette.
3. In the **Symbols** section define a symbol size in pixels and choose a symbol to display objects.



It is recommended to use ordinal symbol size to display points position correctly, otherwise points moved from a current position.



Point objects of vector layer could be displayed both symbols and point with defined size.

4. Set the **Lines** section set the lines **Style** and **Width**;
5. To set the **custom** label font set the appropriate checkbox in the **label font** section;
6. Click the **Apply** button to display changes in 2D-window.
7. Click OK to save parameters.



The vector layer display settings are saved and will be displayed when the vector layer reopens from the resources.



















5. Vector objects

5.1. The “Vectors” toolbar

For quick access to functions of vector objects creating and editing, and also to change modes with vector objects work the system provides the **Vectors** additional toolbar, which buttons partly duplicate the **Edit** menu items. To show the **Vectors** toolbar choose **Window** › **Toolbars** › **Vectors**.

Table 4. The Vectors toolbar

Buttons	Function
	to enable point objects input mode (P) (see Section 5.3.1)
	to enable non-closed polylines input mode (L) (see Section 5.3.2)
	to enable polygons input mode (G) (see Section 5.3.3)
	to enable creating mode of polylines and polygons as smooth lines (see Section 8.6.2)
	to enable CAD-objects creating mode (see Section 5.3.5)
	to enable roofs creating mode (see Section 5.3.6)
	to enable orthogonal input mode of vector objects (see Section 5.3.4)
	to enable orthogonal input mode of vector objects for additional coordinate system (see Section 5.3.4)
	to enable streamline input mode of vector objects (see Section 3.4.4)
	to turn on tracing mode (see Section 3.4.3)
	to enable vertices editing mode (see Section 8.4.1)
	to convert selected broken lines to smooth ones (see Section 8.6.3)
	to convert selected smooth lines to broken ones (see Section 8.6.3)
	to recalculate automatically smoothing of curve line segments during editing (see Section 8.6.4)

Buttons	Function
	to enable curve check points editing (see Section 8.6.5)
	to preserve the smoothness during editing of check points (see Section 8.6.5)
	to select a vertex, located in marker area on a distance specified in the Swath field (Service › Settings › Vectors)
	to move marker to the selected vertex automatically (see the “Settings of vector objects display” chapter of the “ General system’s parameters ” User Manual)
	to turn on/off 2D multi-snapping mode (see Section 3.4.6)
	to turn on/off 3D multi-snapping mode (see Section 3.4.6)
	to turn on/off Snapping to points mode (see Section 3.4.6)
	to turn on/off Snapping to medians mode (see Section 3.4.6)
	to turn on/off Snapping to lines mode (see Section 3.4.6)
	to turn on/off Perpendicular snapping mode (see Section 3.4.6)
	to turn on/off Snapping to coords mode (see Section 3.4.6)
	to create additional (user) coordinate system which is used as a helping vectorization tool together with Snapping to coords function: (see Section 8.8)
	to change default axes direction of additional coordinate system (see Section 8.8)
	to delete additional coordinate system (see Section 8.8)
	to hide/show the classifier window (see Section 6)
	to hide/show the objects attributes window (see Section 7)
	to open window that allows to choose autofilled layer attributes (see the Section 7.4.4)
	to refresh values of autofilled attributes (see Section 7.4.4)
	to calculate density of canopy

5.2. Types of vector objects

The system supports the following types of 3D vector objects:

- *point* – point 3D objects, defined in the space by X, Y, Z coordinates (see [Section 5.3.1](#));
- *polyline* – closed/opened broken line or smooth curve, which consists of vertices connected by segments – straight or curve lines (see [Section 5.3.2](#));
- *polygon* – an areal object, which boundaries are closed polyline (see [Section 5.3.3](#));
- *CAD-objects* standard geometric figures, for example, ellipse, circle, rectangle, arc (see [Section 5.3.5](#));

During vector objects creation use the tools for stereomarker managing (see [Section 3.4](#)).



The system provides possibility to synchronously display marker position in multiple opened windows for created vector objects. To do this use the **Edit** › **Sync markers** menu item.

To increase vectorization performance the system provides possibility to use special 3D or multibutton mice, as well as to use programming of buttons of usual mouse to perform particular operations (see the “[General system’s parameters](#)” User Manual).

To draw or edit vector objects, create, load or make active vector layer in the Manager panel.

For quick access to modes and functions of vector objects editing, use buttons of the **Vectors** additional toolbar (see [Section 5.1](#)).

5.3. Creation of vector objects

5.3.1. Points creation

Perform the following actions for creating a point:

1. Choose **Edit › Vectors create mode › Points (P)** or click the  button of the **Vectors** additional toolbar to turn on points creation mode.
2. Place marker to selected point on image in 2D-window.
3. Press **Insert** to create a point.

5.3.2. Polylines creation

Perform the following actions for creating a polyline:

1. Choose **Edit › Vectors create mode › Polylines (L)** or click the  button of the **Vectors** additional toolbar to turn on polylines creation mode.
2. For each polyline vertex perform the following actions:
 - place marker to selected point on image in 2D-window;
 - press **Insert** to create a vertex.
3. Press **Enter** or **Esc** to complete polyline creation.

To close a polyline while its creation select **Vectors › Topology › Close selected polylines** or use the **Shift+C** hotkeys after input of the last vertex (see [Section 11.4.1](#)). See description of orthogonal polyline creation in the [Section 5.3.4](#).

5.3.3. Polygons creation

Perform the following actions for creating a polygon:

1. Choose **Edit › Vectors create mode › Polygons (G)** or click the  button of the **Vectors** additional toolbar to turn on polygons creation mode.

2. For each line vertex:
 - place marker to selected place on image in 2D-window;
 - press **Insert** to create a vertex.
3. Press **Enter** or **Esc** to close polygon and end its creation.

See description of orthogonal polygon creation in the [Section 5.3.4](#).

5.3.4. Creation of orthogonal objects

During vectorization of some types of vector objects (buildings, for instance) polyline or polygon should be composed of segments connected to each other at right angles.

To do this use the following modes of vector objects creation:

- Orthogonal mode;
- Orthogonal mode for [additional coordinate system](#);
- **Snap to coordinates** mode.



These modes are used during creation of both polylines and polygons (see [Section 5.3.3](#) and [Section 5.3.2](#)).

In order to enable orthogonal mode of vector objects creation use one of the following ways:

- if it is necessary to make part of a line with right angle, when you enter the next line segment, press and hold the **A** key; to continue the line in usual mode, release the key;
- click the  button of the **Vectors** additional toolbar or choose **Edit › Orthogonal mode** to enable continuous orthogonal vectorization mode.



To close a polyline in orthogonal mode after entering of the last vertex select **Vectors › Topology › Close selected polylines** or use the **Shift+C** hotkeys, and then press **Esc** (see [Section 11.4.1](#)).



In order to finish the vector object to a rectangular shape, after entering the last vertex use hotkeys **A+Enter** (or press **Enter**, if the orthogonal mode is on). As a result, the last vertex of a vector object is moved so that the object takes a rectangular shape.



To move the first vertex use the **A+Ctrl+Enter** hotkeys (or **Ctrl+Enter**, if the orthogonal mode is on).



In order to enable orthogonal mode of vector objects creation for additional coordinate system perform the following:

1. create additional coordinate system and change its default axes direction;
2. click the  button of the **Vectors** additional toolbar or choose **Edit > Orthogonal mode in coordinate system** to enable continuous orthogonal vectorization mode in additional coordinate system.



Created vector objects will be orthogonal to the axes of the additional coordinate system, and their directions are user-defined.

In order to enable **Snap to coordinates** mode of vector objects creation use one of the following ways:

- choose **Edit > Snapping > 2D snapping** or **Edit > Snapping > 3D snapping** to enable continuous **2D snapping** or **3D snapping** mode (see [Section 3.4.6](#)). Choose **Edit > Snapping > Snap to coordinates** to enable continuous **Snap to coordinates** mode;
- press the **B** key to enable continuous **2D snapping** mode. Press the **M** key to enable continuous **Snap to coordinates** mode;
- click the  or  button of the **Vectors additional toolbar** to enable continuous **2D snapping** or **3D snapping** mode. Click the  button of the **Vectors additional toolbar** to enable continuous **Snap to coordinates** mode.

See the detailed description of working in **Snap to coordinates** mode in the [Section 3.4.6](#).

The system also allows to **edit** vector objects moving their vertices in directions parallel or perpendicular to the adjacent segments, as well as to move these vertices to the segments of the edited object (or the segments of the neighboring objects) towards the perpendicular to these segments using the [perpendicular snapping mode](#).

See the description of orthogonality control in the [Section 10.2.6](#).

5.3.5. CAD-objects creation

To create vector objects of standard geometric shape click the  button of the **Vectors** additional toolbar, or choose **Window > Toolbars > CAD objects** or choose **Edit > Vectors create mode > CAD objects**. The **CAD objects** window opens.

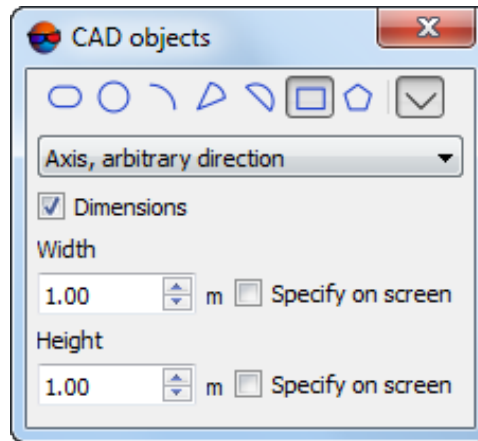









Fig. 40. Menu for CAD-objects creation

The button allows to open the options bar for each object type, in accordance with which the object is created.

Table 5. Functionality of the CAD objects window

Buttons	Function
	Ellipse creation ways: <ul style="list-style-type: none"> • Axis, arbitrary direction – allows to set a size of one of axes; another axis is created at arbitrary direction from the specified one; • Axis, fixed direction – allows to set a size of one of axes; second axis is built strictly perpendicular to a given one; • Center, arbitrary direction – allows to set a center and a size of one of axes; another axis is created at arbitrary direction from the specified one; • Center, fixed direction – allows to set a center and a size of one of axes; second axis is built strictly perpendicular to a given one;
	Round creation ways: <ul style="list-style-type: none"> • 2 points – allows to specify a diameter of the round created; • Center, radius – allows to specify the round center and radius; • 3 points – allows to create a round using three points.
	Arc creation ways: <ul style="list-style-type: none"> • 3 points – allows to create a arc using three points, the first point is the beginning of the arc; • Center, arbitrary radius – allows to draw an arc with arbitrary radius, the first point is the center of the arc; • Center, fixed radius – allows to draw an arc with fixed radius, the first point is the center of the arc;

Buttons	Function
	Sector creation ways: <ul style="list-style-type: none"> • Center, arbitrary radius – allows to set center, drawing direction and arc radius; • Center, fixed radius – allows to set center, arc radius and size;
	Segment creation ways: <ul style="list-style-type: none"> • Start, end, arc – allows to set start and end points of straight part of segment and arc size; • 3 points – allows to create segment using three points, the first point is the beginning of the segment; • Center, arbitrary radius – allows to set center, drawing direction and arc radius; • Center, fixed radius – allows to set center, arc radius and size;
	Rectangle creation ways: <ul style="list-style-type: none"> • 3 points – allows to specify three vertices of the rectangle; • Axis, arbitrary direction – allows to set a center and a size of one of sides; the second size is created at arbitrary direction from the specified one; • Axis, fixed direction – allows to set a center and a size of one of sides; second axis is built strictly perpendicular to a given one;
	Polygon creation ways: <ul style="list-style-type: none"> • 2 points – allows to create a polygon using two specified points. • Center, radius – allows to set center, drawing direction and polygon radius;



Creation of any type of CAD-objects starts from pressing the **Insert** key.

Perform the following actions to create CAD-object of arbitrary type (ellipse, round, arc, sector or segment):

1. Click one of buttons of the **CAD objects** window toolbar.
2. Specify approximation accuracy in the **Precision** field.



CAD-objects, presented in the form of curves are approximated by broken lines, that is why, curvature of the object can be measured by approximation precision, that is maximal distance from broken line segment to the curve between its two closest vertices. Creation precision could be specified for objects that contain curvy parts (ellipse, round, arc, sector, segment). This parameters default value is – 0.5, in measurement units of current project.

3. Press **Insert** to start create object.

4. Move mouse and press **Insert** to specify parameters and size of the object.
5. To complete drawing press **Enter**, to cancel object creation – **Esc**.



To create in a layer with classifier linear CAD-objects (arcs), select in classifier type (L), if it is necessary to create areal object – select type (C) (see [Section 6](#)).

Perform the following actions to create polygon:

1. Click the  button of the **CAD objects** window toolbar.

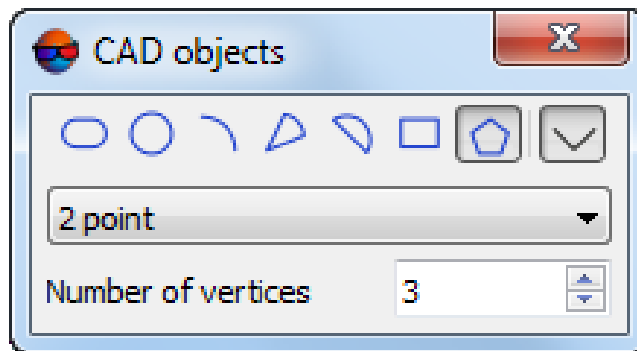

Fig. 41. Menu for CAD-objects creation

2. Specify number of polygon vertices. By default creates polygons with 3 vertices.



It is possible to create polygon with up to 500 vertices.

3. Press **Insert** to start create object.
4. Move mouse and press **Insert** to specify parameters and size of the object.
5. To complete drawing press **Enter**, to cancel object creation – **Esc**.

Perform the following actions to create rectangle:

1. Click the  button of the **CAD objects** window toolbar.

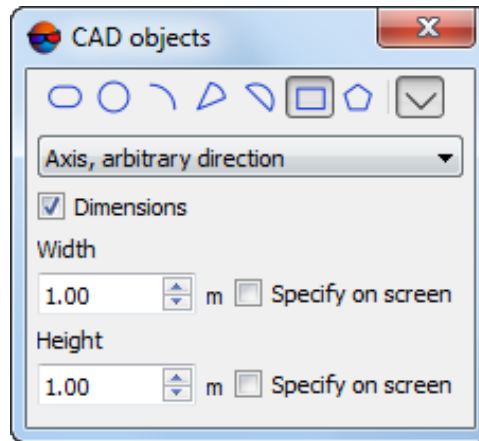

Fig. 42. Menu for CAD-objects creation

2. [optional] If the rectangle must have fixed **dimensions**, set the corresponding checkbox:
 - [optional] Specify rectangle **width** and **height**, in project units;
 - [optional] To specify the required rectangle **width** and **height** on the screen, perform the following (step-by-step for both values):
 - Set the **specify on screen** checkbox. The measurement mode is switched on;
 - To start measuring, click the **left mouse button**;
 - Move the mouse and click its left button to complete measuring. The resulting value is displayed in the appropriate field;
 - Press **Esc** to quit the measurement mode .
3. Press **Insert** to start create object.
4. Move mouse and press **Insert** to specify parameters and size of the object.
5. To complete drawing press **Enter**, to cancel object creation – **Esc**.

Conversion of vector object to geometric shape is described in [Section 11.4.3](#).

Adding an arc to a polyline

The system allows for adding an **arc**-type CAD-object to a polyline (as its **fragment**) directly during polyline creation. As a result, the system allows to immediately create a single vector object, partially eliminating appropriate **topological operations**.

To do this, perform the following:

1. Choose **Service** › **Settings** or click  button of the main toolbar. In **Settings** window select **Vectors** tab and set the **Join polylines and arcs** checkbox;
2. Start polyline [creation](#);
3. Not finishing polyline creation, select an **arc** object by clicking the appropriate button on the **CAD objects** toolbar;
4. Switch on the **Snap to points** mode (**2D snapping** or **3D snapping** depending on the need);
5. Using enabled **Snap to points** mode, place the marker at the location of the latest input vertex of the created polyline by clicking the **left mouse button**. The End label appears in the vicinity of this vertex;
6. Press **Insert** to start create arc.
7. Move mouse and press **Insert** to specify parameters and size of the arc.
8. To complete arc creation press **Enter**. A single vector object is created, which is a polyline with an arc as an end fragment;



The system allows to go on creating this polyline as a single vector object using [standard topological operations](#). To do this, perform the following:

9. Switch off the CAD objects creation mode;
10. [optional] Switch off snapping mode;
11. [optional] Clear the **Join polylines and arcs** checkbox in the **Vectors** tab of the **Settings** window;
12. [Select](#) polyline in 2D-window;
13. Place marker in vicinity of vertex of polyline fragment beginning, to which it is necessary to add new vertices;
14. Choose **Vectors** › **Topology** › **Object fragment** › **Select start point of fragment (Alt+S)**;
15. Add more vertices to continue creation of polyline;
16. Press **Esc** to complete polyline editing.

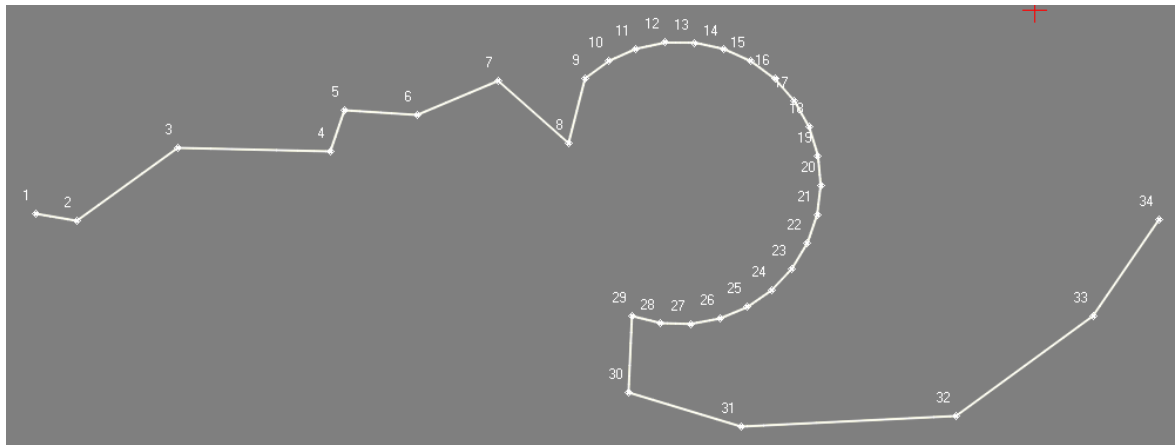

Fig. 43. A polyline with an arc as its fragment

5.3.6. Roofs creation

The *PHOTOMOD* system provides tools for rapid stereovectorization of buildings. These tools allow for creating **topologically connected** combinations of polygons and polylines that describe the roofs of various buildings, therefore manual project processing becomes less labor-consuming.

The system provides for rapid creation of vector object combinations with preset options that describe the most common types of roofs:

- **Shed** – rests on two outer walls of varying heights;
- **Flat** – rests on outer walls of the same height;
- **Gable** – rests on two outer walls of the same height;
- **Butterfly** – gable roof with slopes directed “inside” to collect moisture;
- **Mansard** – single-level with gambrel roof;
- **Hip** – gable roof with ridge beam;
- **Gambrel** – gable roof, each plane slope is 2 rectangles connected at an obtuse angle;
- **Combi** – consists of elements of a mansard and attic roofs;
- **Steeple** – roof with highly elongated cone or pyramid;
- **Hangar** – arch-type elongated roof;
- **Cone** – **Steeple** with an arbitrary number of faces;

- **Parapet** – low barrier at the edge of building roof. The system allows to create such type of roofs in **manual** and **semiautomatic** mode;
- **Multi-section**;
- **Dome** – in automatic mode. To set the dome's surface curvature precisely or create a dome of irregular shape, the **manual** mode of dome creation is used.
- **Arc hipped roof**;
- **Box bay** – wide top or pointed top;
- **Semi hexagonal bay** – wide top or pointed top;
- **Semi octagonal bay** – wide top or pointed top;
- **Semi cone bay** – arc or semi-circle.



Elevations of vector polygon vertices that delineate roofs can be set manually after the appropriate [calculation](#) .

Perform the following actions for creating a roof:

1. Open a stereopair for vectorisation and turn on **stereo mode**.
2. Click the  button of the **Vectors** toolbar, or choose **Window › Toolbars › Roofs** or choose **Edit › Vectors create mode › Roofs**. The roofs creation mode turn on and the **Roofs** window opens.

In the left part of **Roofs** window a list of roof types is placed. In the right side – a figure of selected roof type and an order of roof corners to be drawn (1, 2, 3 etc.).

Various roof shape and/or corner denotation order options are provided for **shed**, **flat**, **gable** and **mansard** roofs.

For **Hangar**, **Cone** and **Parapet** roof types in the right side of the window fields to input additional parameters are placed.

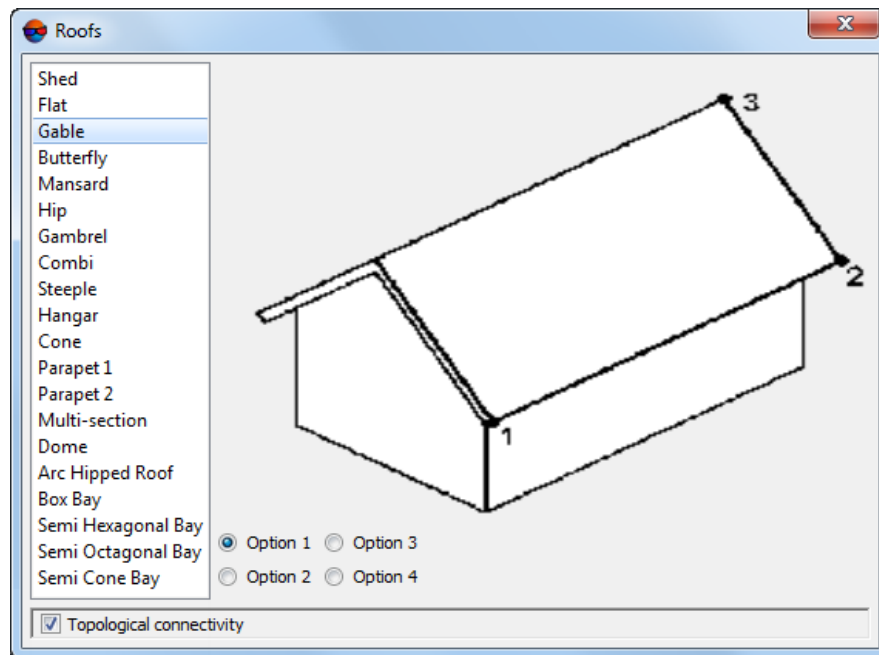

Fig. 44. Roofs types

3. Select desirable roof type in the **Roofs** window.
4. [optional] Choose the appropriate roof shape and/or corner denotation order;
5. [optional] Set the **Topological connectivity** checkbox;
6. Place marker to roof lower corner and press **Insert**.
7. Sequentially place marker to other corners of the roof and press **Insert** in each corner.



Rotate mouse wheel to set the ridge height.



Press **Backspace** to undo the latest corner input.



If to set a height of **Gable** rooftop less than a height of its bottom corner, the roof is rebuilt automatically (a rooftop and the bottom corner will «change places»). Respectively for a **Butterfly**, roof type a converse is true.

8. [optional] Edit a width of the roof keeping **left mouse button**.
9. To complete editing press **Insert**.



Roof vertices edit in the same way as any [vector objects](#).



To exit roofs creation mode, close the **Roofs** window.



Is it possible to view DTM (including vector objects) in a 3D-space in mono or stereomode (see the “Process in 3D-window” chapter of the “[General information](#)” User Manual). To perform visual control of roofs creation choose **Window** > **3D window**. The **3D window** opens.

Topological connectivity of elements of the created roof allows for selecting various functional elements within the roof for further editing.

When the **Topological connectivity** checkbox is set, the corresponding attributes are assigned to various elements of the created combination of vector objects:

- "type": object – for the roof outline;
- "type": break – for the roof’s ridge, if any (except for **shed**, **flat**, and **parapet** roof types)..



To check the attribute value, select a vector object and choose **Window** > **Object attributes** or click the  button on the **Vectors** additional toolbar. The **Object attributes** window opens.

Topological connectivity also ensures correct import of vector objects for further processing in *PHOTOMOD 3D-Mod* (**Vectors** > **Open vectors in 3D-Mod**).

Set this checkbox for further creation of integrated 3D objects when importing vector data into *3D-Mod* (see “Import from PHOTOMOD” chapter of the “[Three-dimensional modeling](#)” User Manual).

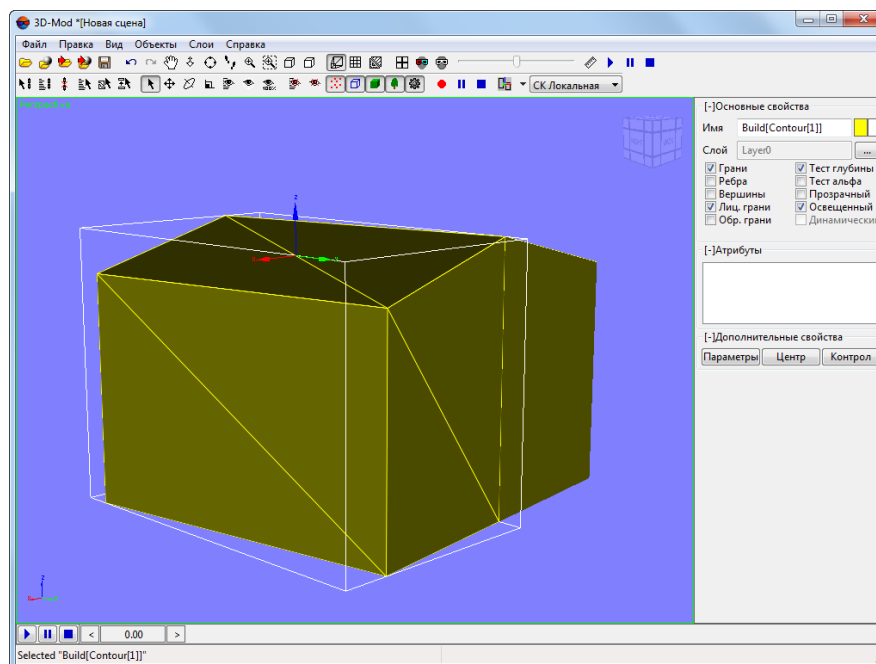

Fig. 45. Two 3D objects generated when importing a vector object (gable roof) created with topological connectivity disabled

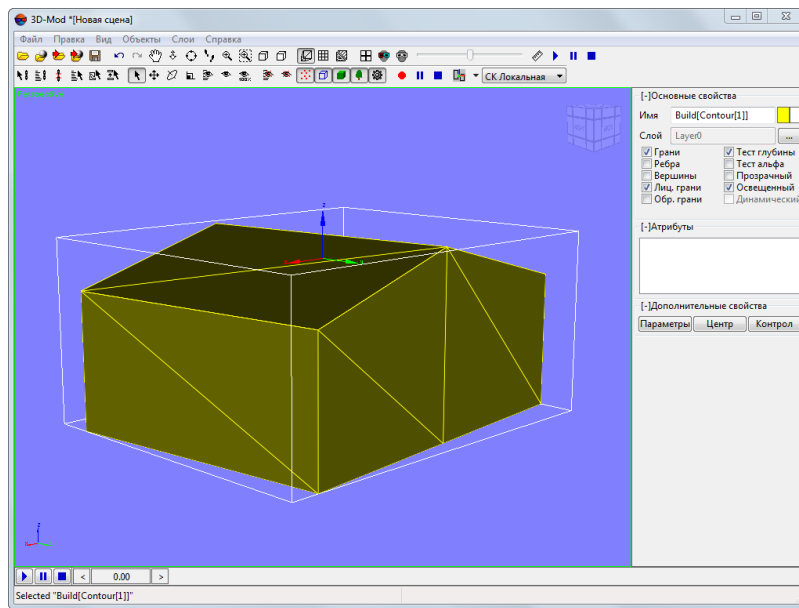

Fig. 46. An integrated 3D object generated when importing a vector object (gable roof) created with topological connectivity enabled

Creating Hangar roof type

Perform the following actions to create a **Hangar** roof:

1. Open a stereopair for vectorisation and turn on [stereo mode](#).
2. In the **Roofs** window choose the **Hangar** roof type.

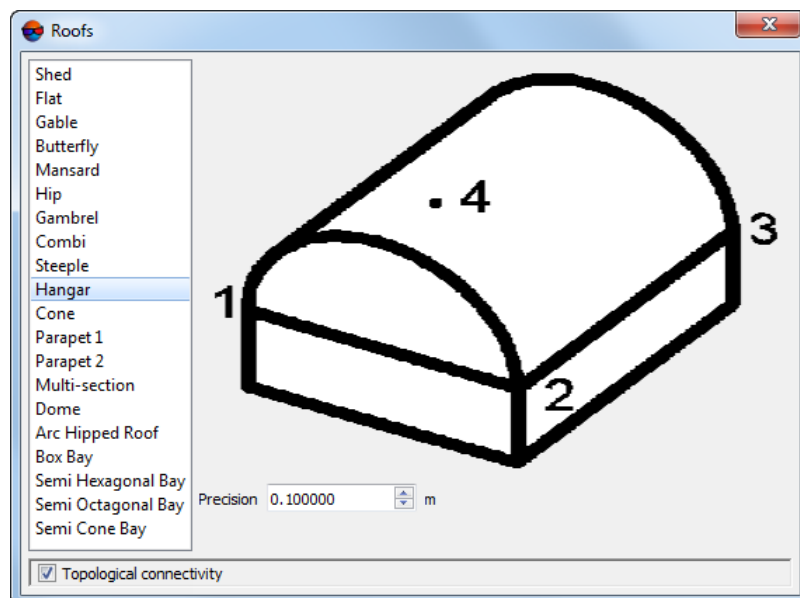

Fig. 47. Hangar roof type

3. In the **Precision** type set the precision of arches cycle approximation (in meters).
4. Place marker to roof lower corner and press **Insert**.
5. Place marker to the second lower corner (to set width of roof) and press **Insert**.
6. Place marker to set the length of roof and press **Insert**.
7. Set marker inside of roof contour.
8. Rotate mouse wheel to set the ridge height.



The system generates approximation lines during height setting.

9. To complete editing press **Insert**. To exit roofs creation mode, close the **Roofs** window.

Creating Cone roof type

To create **Cone** roof type, perform the following:

1. Open a stereopair and turn on [stereovectorization mode](#);
2. In **Roofs** window select **Cone** roof type;

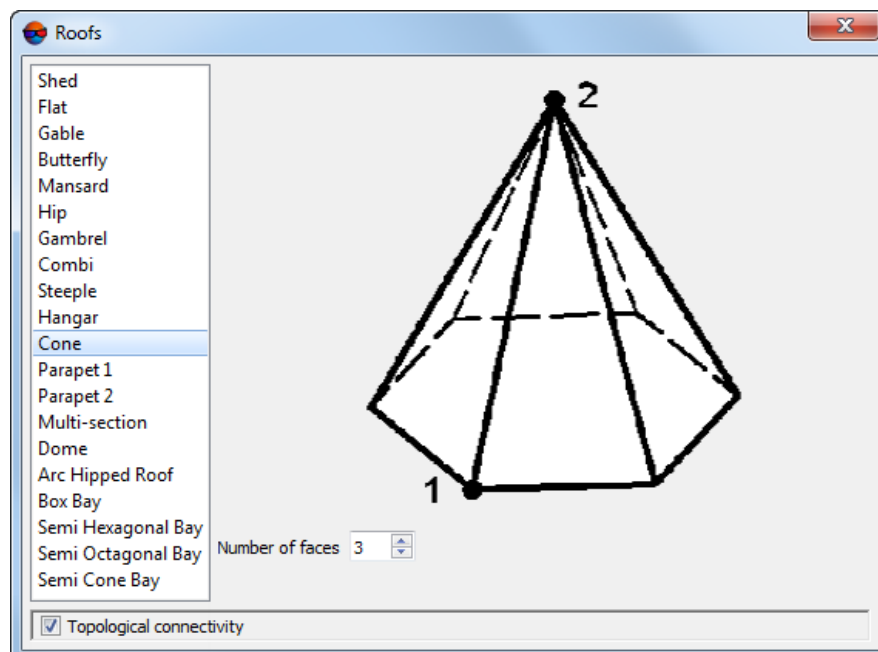

Fig. 48. Roof type “Cone”

3. Input **number of faces**;
4. Set marker in the bottom corner of the roof and click **Insert** key;
5. Set marker in the rooftop;
6. Rotate a mouse wheel to set a height of the rooftop;



If to set a height of rooftop less than a height of its bottom corner, the roof is rebuilt automatically (a rooftop and the bottom corner will “change places”).

7. [optional] Edit a size and position of the roof keeping **left mouse button**;
8. To complete editing click **Insert** key. To exit Roof creation mode, close **Roofs** window.

Creating Parapet roof type in manual mode

To create **Parapet** roof type in manual mode, perform the following:

1. Open a stereopair and turn on [stereovectorization mode](#);
2. In **Roofs** window select **Parapet 1** roof type;

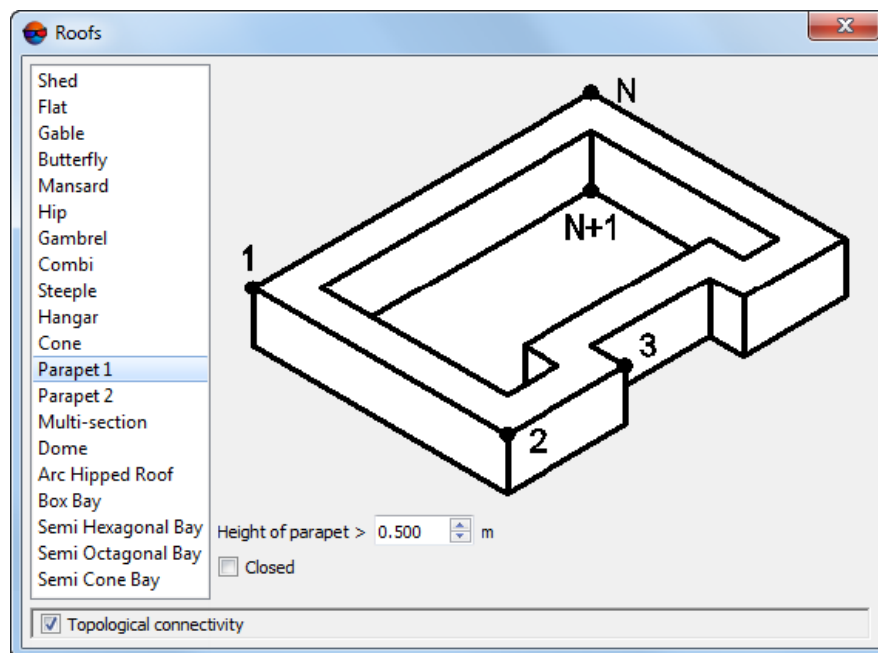

Fig. 49. Roof type “Parapet”

3. [optional] Turn off a checkbox **Closed** to create non-closed parapet;

4. Set a minimum parapet height with inputting **Height of parapet >** value;



A meaning of **Height of parapet >** parameter is the following. A difference of heights between point “N” and “N+1” is no less than <...> m. A height of parapet is set by user while stereovectorization later but no less than input value, otherwise a parapet will not be built.

5. Move a marker to parapet corners step by step and click **Insert** key N times;



Press the **Backspace** key to cancel the last corner entry.



Do not move a marker after corner “N” is specified.



A parapet shape is not limited by rectangle one. It can be a polygon with arbitrary number of vertices.

6. Once specified roof corner “N” with **Insert** key, *no moving marker*, set a *height difference* between points “N” and “N+1” while rotating mouse wheel.

After a height difference is over **Height of parapet >** value a parapet is closed between corners “1” and “N” (in case of creating closed parapet). If a height difference is less than **Height of parapet >** value again, a parapet will be unclosed.



Further parapet editing is impossible if specified height difference is less than **Height of parapet >** value.



In case of creating non-closed parapet, the system does not close it while specifying a height with rotating mouse wheel.

7. Set a position of point “N+1” (i.e. a width of parapet) with moving a marker;
8. [optional] If necessary, edit a width and a height of parapet with moving marker and rotating a mouse wheel respectively;
9. To complete editing click **Insert** key. To exit Roof creation mode, close **Roofs** window.

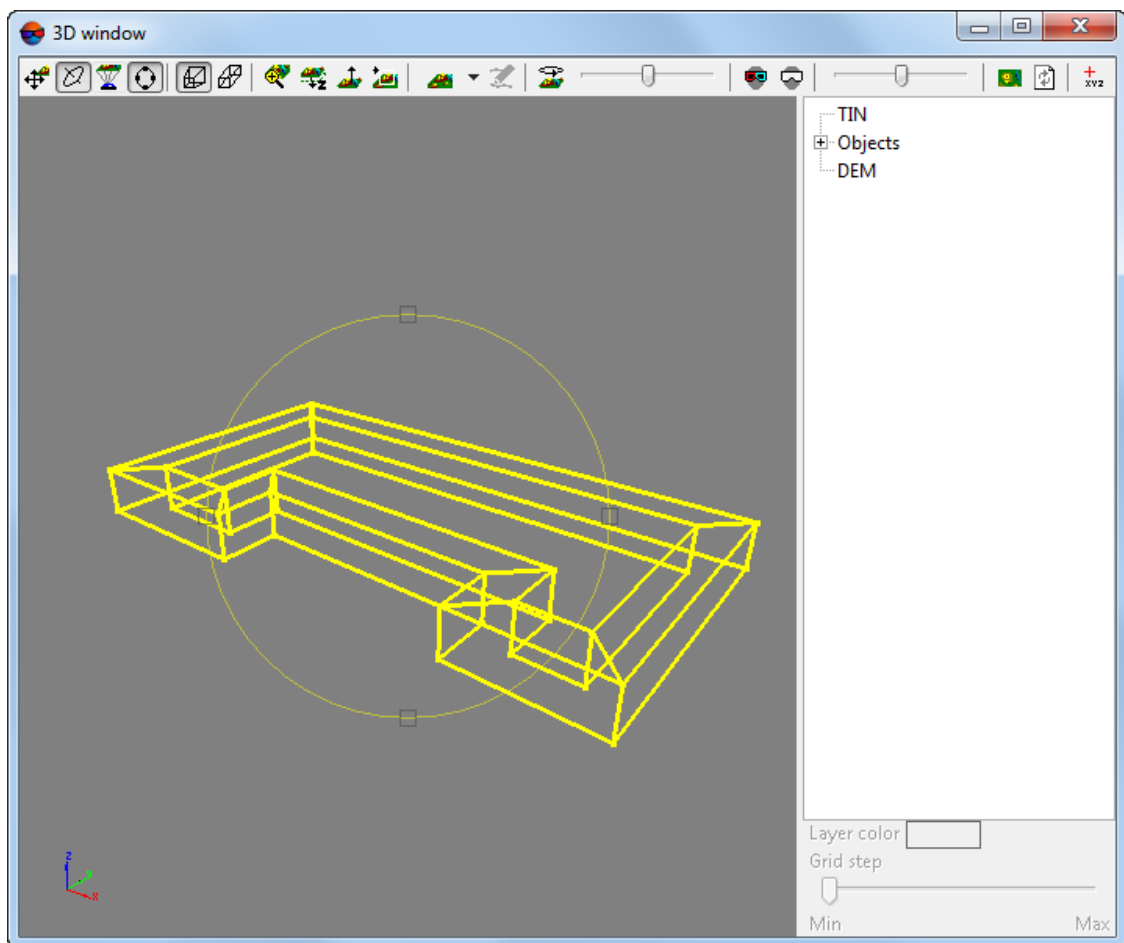

Fig. 50. Roof type “Parapet” in 3D-window

Creating Parapet roof type in semiautomatic mode

To create **Parapet** roof type in semiautomatic mode, perform the following:

1. Open a stereopair and turn on [stereovectorization mode](#);
2. In **Roofs** window select **Parapet 2** roof type;

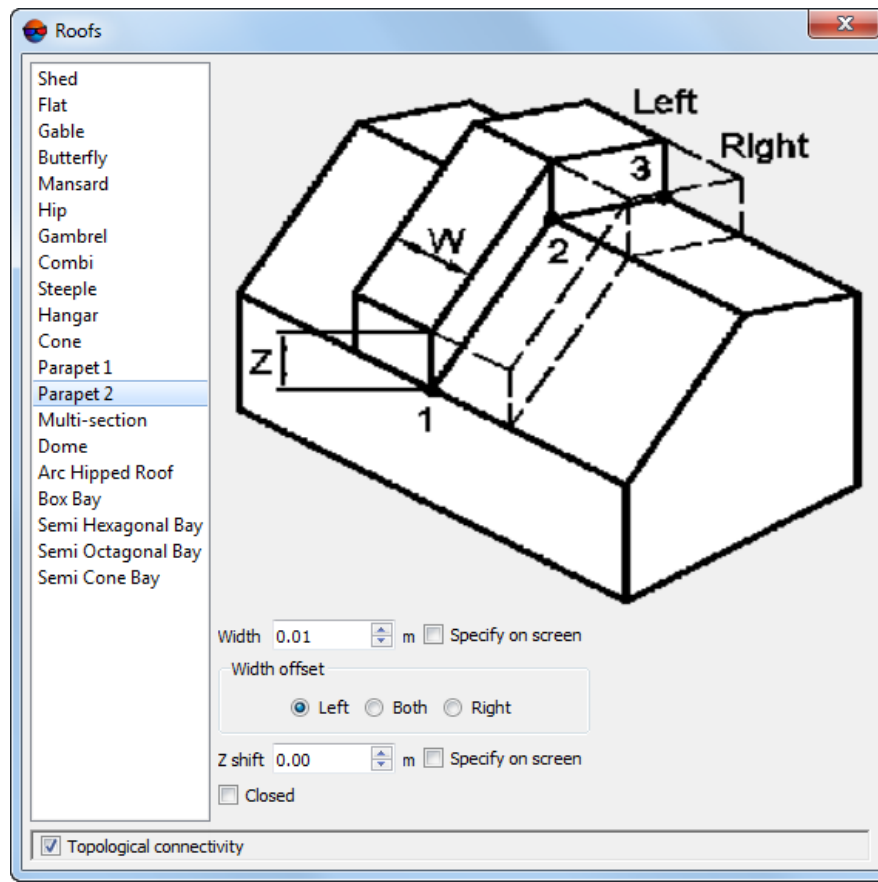





Fig. 51. Parapet-type roof, where: W is the parapet **Width**, Z is the parapet height, Left or Right is the parapet's position in relation to the polyline segments (between vertices **1**, **2**, **3**, and so on) which determine the position of the parapet in XY plane (see **Width offset** parameter).



3. Set the parapet's width (W) in meters using the following methods:
 - Enter the value of the parapet's width in the **Width** field;
 - Set the parapet's width using a mouse. To do this, perform the following:
 1. Set the **Specify on screen** checkbox;
 2. Set the start point of the interval which sets the parapet's width by **left mouse button** click;
 3. Move the marker and click the **left mouse button** to set the final point of the interval which sets the parapet's width. The interval defining the width of the parapet is displayed on the screen as a gray guide, and its size in meters is automatically displayed in the **Width** field;
 4. [optional] If necessary, edit the parapet's width by moving the marker and clicking the **left mouse button**;

5. Press **Enter** to set the parapet's width. The **Specify on screen** checkbox will be cleared automatically.
4. In **Width offset** section set the position of the parapet in relation to the polyline which determine the position of the parapet in XY plane:
 - **Left** – the parapet will be placed to the left of the polyline;
 - **Right** – the parapet will be placed to the right of the polyline;
 - **Both** – the polyline will be the central axis of the created parapet.
5. Set the parapet's height (Z) in meters doing one of the following:
 - Enter the parapet's height in the **Z shift** field;
 - Set the parapet's height using a mouse. To do this, perform the following:
 1. Set the **Specify on screen** checkbox;
 2. Clicking the **left mouse button**, turn on the height setting mode;

 Repeated **left mouse button** click resets the height value in the **Z shift** field to zero.
 3. Set the parapet's height rotating the **mouse wheel** (height in meters is automatically displayed in the **Z shift** field);
 4. Press **Enter** to set the parapet's height. The **Specify on screen** checkbox will be cleared automatically.
6. [optional] Set a checkbox **Closed** to create closed parapet;
7. Moving the marker stepwise in the XY plane and pressing the **Insert** button, create vertices which determine the position of the parapet in the XY plane according to the order in the scheme (vertices 1, 2, 3, and so on);

 Press the **Backspace** key to cancel the last corner entry.

 The polyline which determine the position of the parapet in XY plane is not displayed on the screen. The created parapet is displayed as gray polygons until the parapet is finished.
8. To finish the parapet creation, press **Enter**. The parapet is automatically heightwise shifted according to the value set in the **Z shift** field. In case of a closed parapet, the parapet's contour closes automatically.

-  To create a non-closed parapet, it is enough to enter two vertices.
-  To create a closed parapet, enter at least three vertices.
-  When creating a closed parapet, **self-intersection** of the polyline determining the parapet's position on the plane is not allowed. This is true also for the last segment, which is created automatically when the parapet closes (i.e. closes the polyline into a polygon).

9. [optional] To exit Roof creation mode, close **Roofs** window.

-  To create a parapet above the roof (as on the schematic image), perform the following:
 1. **Create** a roof (e.g. **gable**);
 2. Turn **snapping** mode on to provide exact spatial coincidence of the roof and parapet (e.g. **Snap to lines** and **Snap to coordinates** combination in 3D-snapping mode);
 3. "Abutting" to an eave or a hip using 3D-snapping, create a parapet in semiautomatic mode;

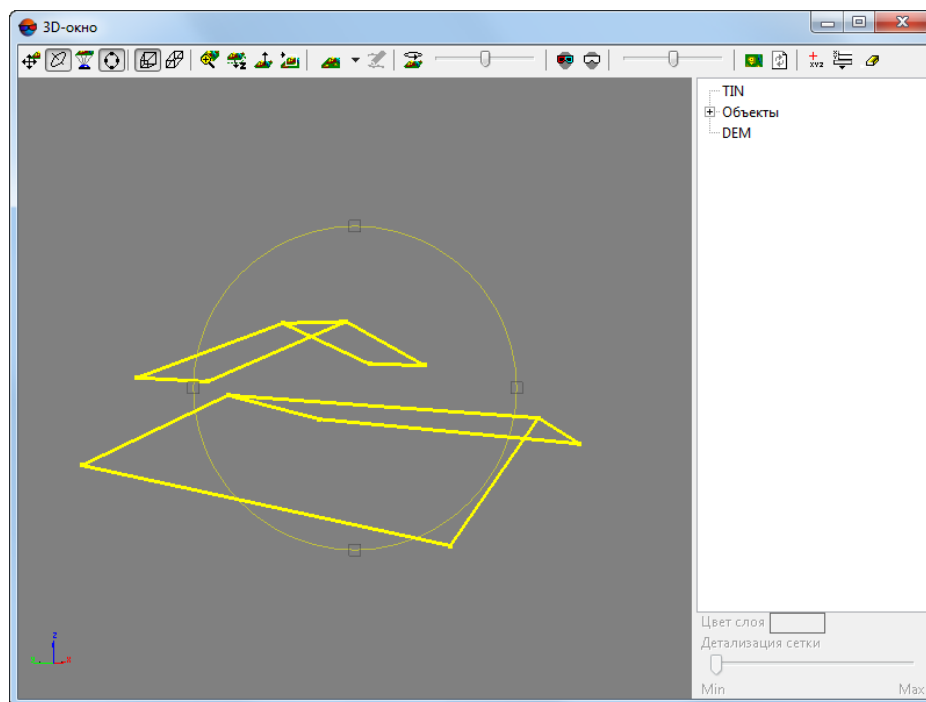



Fig. 52. A parapet above a **gable** roof created in semiautomatic mode

-  Parapets created in semiautomatic mode (unlike those created in **manual** mode) have no vertical hips.

-  The system allows to vary **Z shift** manually during parapet creation in semiautomatic mode. To do this, when creating vertices determining the parapet position (see item 6), move marker not only horizontally but also vertically (by rotating **mouse wheel**).

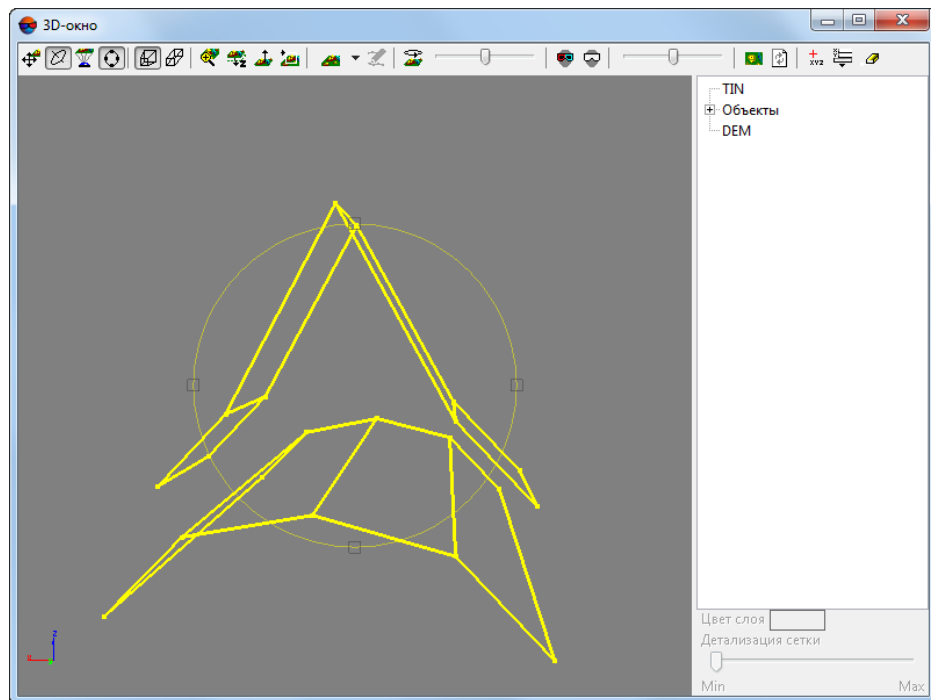

Fig. 53. A parapet above a **gambrel** roof in the 3D-window. **Z shift** of the parapet vertices above the roof hip is enlarged manually.



To change **Z shift** manually when creating a parapet vertex, you need temporarily disable **3D snapping** mode if it is used (e.g. by turning **2D snapping** mode on).

Multi-section roofs

To create a **multi-section** roof, perform the following:

1. Open a stereopair and turn on **stereovectorization mode**;
2. In **Roofs** window select **multi-section** roof type;

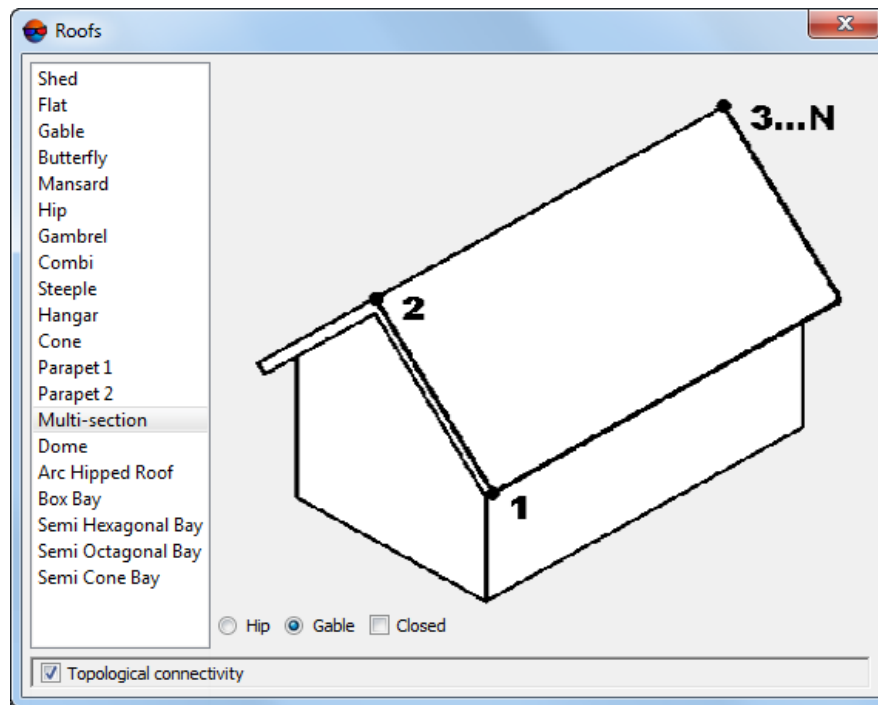

Fig. 54. A multi-section roof

3. Select the multi-section roof type:

- **Hip**;
- **Gable**.
 - [optional] set the **Closed** checkbox.

4. Moving the marker stepwise in the XYZ plane and pressing the **Insert** button, create vertices which determine the position of the first section of the roof according to the order in the scheme (vertices 1, 2 and 3);



When the first and the second vertices are entered and the marker is moved at the place of the third vertex nearby, the first roof section is displayed as gray polygons.

Adjust the first section's length and width (as well as its position on the plane) by moving the marker, and press **Insert** third time to complete the creation of the first roof section.

5. Moving the marker stepwise and pressing the **Insert** button, create the succeeding sections;

6. To finish the roof creation, press **Enter**. In case of the **closed** gable multi-section roof, the final (closing) section will be created automatically.

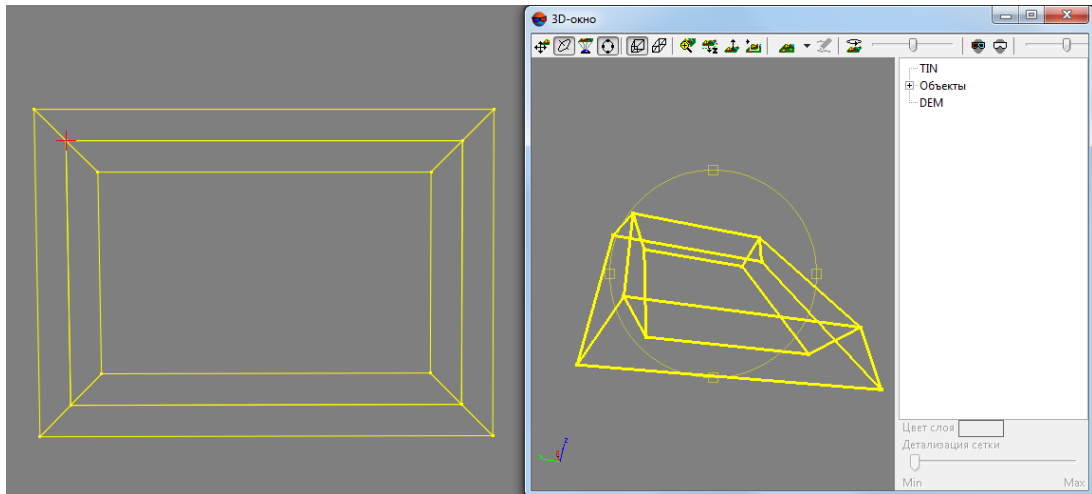

Fig. 55. A closed gable multi-section roof

Dome creation

To create a dome in automatic mode, perform the following:

1. Open a stereopair and turn on [stereovectorization mode](#);
2. Choose **Dome** in the **Roofs** window;

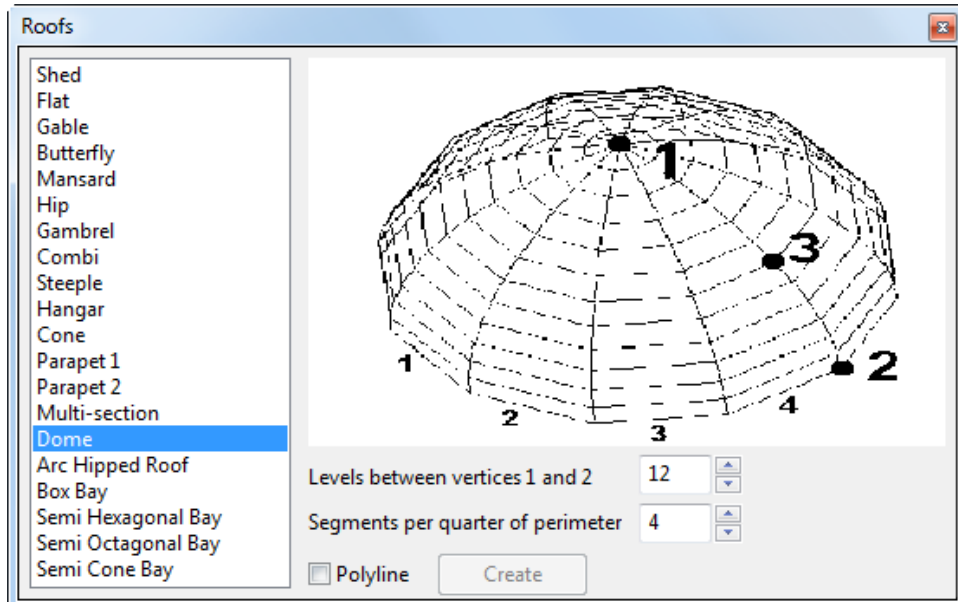

Fig. 56. A dome. Big figures denote the dome's vertices. Small figures are the numerical orders of segments in one of the dome quarters (4 by default)

3. [optional] clear the **Polyline** checkbox, if it is set;

4. Set the following options for a dome construction (according to the sketch):
 - **Levels between vertices 1 and 2** – is not less than 2 and not more than 100;
 - **Segments per quarter of perimeter** – is not less than 1 and not more than 100.
5. Sequentially moving the marker in the XY plane and along the Z-axis and pressing the **Insert** button, create vertices that define the shape and size of the dome according to the order in the sketch:
 1. Place the marker at the dome apex, set the required height and press **Insert**;
 2. Moving the marker in the XY plane, choose any point at the basal part of the dome. The boundary of the dome's basal part is a gray polygon. Reduce the marker height so that it matches the height of the basal part of the dome, and press **Insert**;

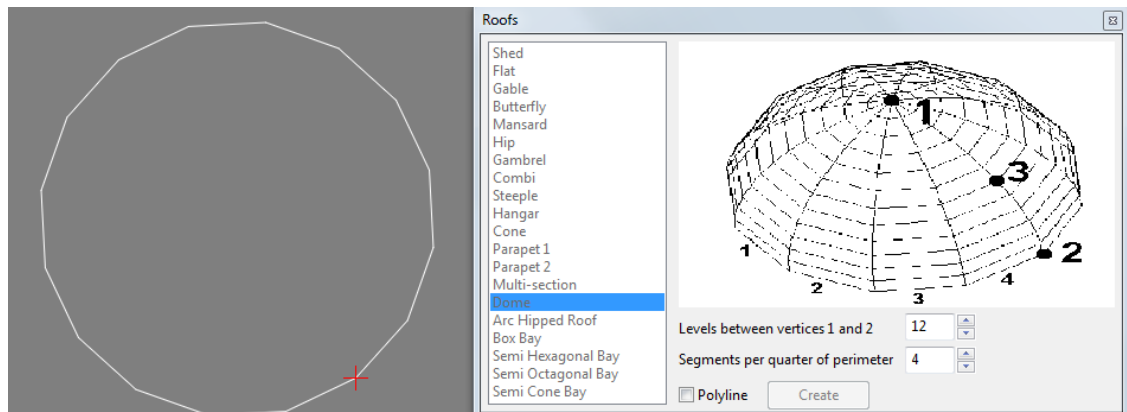

Fig. 57. Boundary of the basal part of a dome

3. Moving the marker in the XY plane, choose any point on the dome's surface (inside the polygon limiting the dome's basal part). Increase the marker height until the dome is fully displayed as gray polygons, otherwise, the dome creation is not complete;



The system availability for automatic dome creation (a dome is completely displayed as gray polygons) depends on the ratio of elevations of vertices 1, 2, and 3.

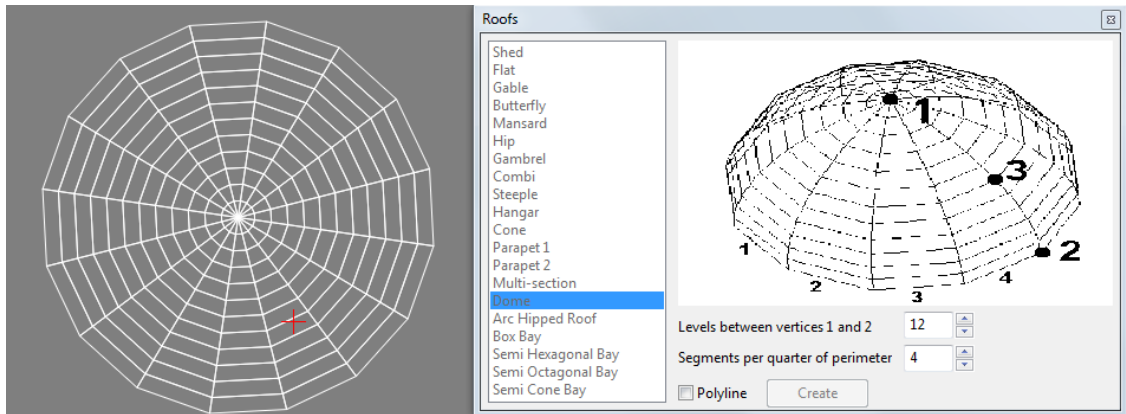

Fig. 58. A dome ready for construction

6. [optional] varying the marker height, adjust the dome's surface curvature;



To set the dome's surface curvature precisely or create a dome of irregular shape, use **manual** mode of dome creation.

7. To complete the dome creation, press **Insert**.

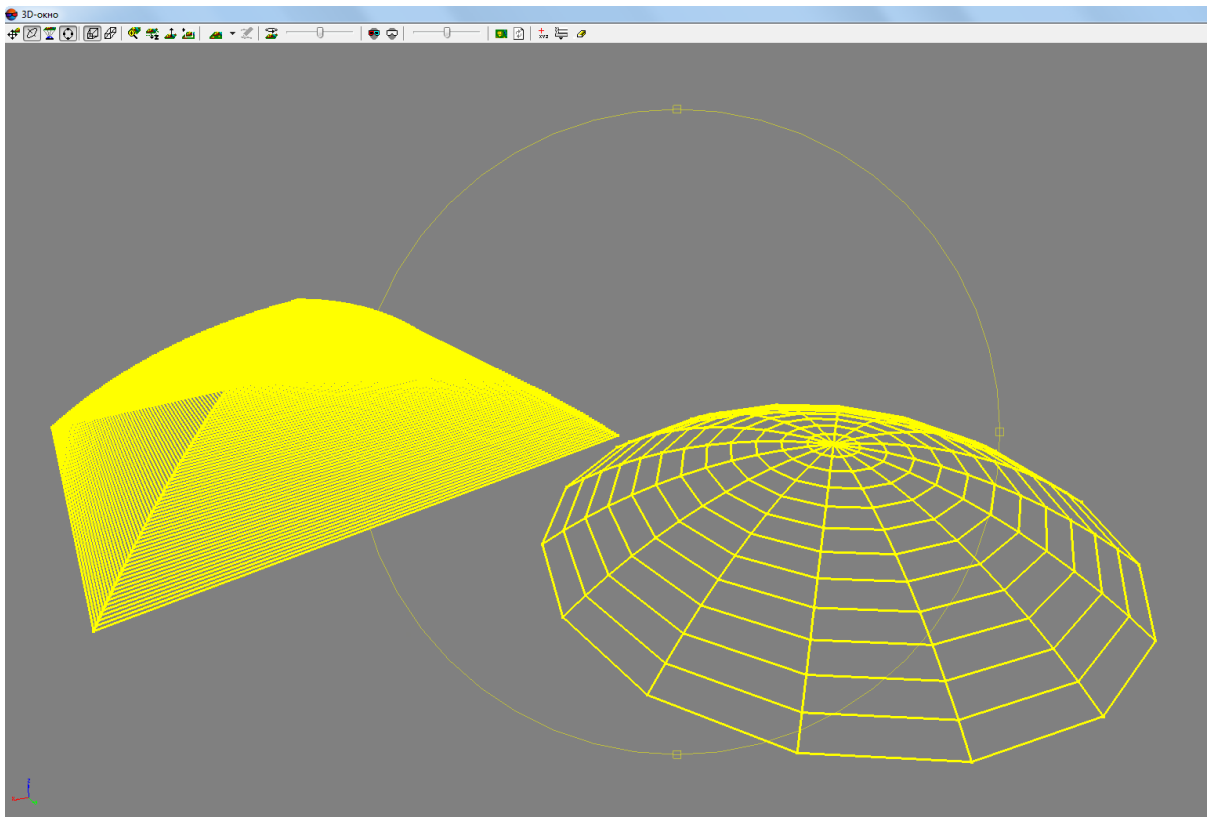

Fig. 59. Automatically created domes with different construction parameters

Manual dome creation

To construct a dome manually, perform the following:

1. Open a stereopair and turn on [stereovectorization mode](#);
2. Create a polyline with arbitrary number of vertices that describe a shape of one of the dome ribs (see vertices 1, 3, and 2 in the picture);



When entering polyline vertices, move the marker arbitrarily in the XY-plane and/or along the Z-axis.



To create a straight polyline from several segments, use one of [snapping modes](#). A straight polyline is not obligatory for a dome creation.

3. Open the **Roofs** window when the created polyline is still not deselected;
4. Choose the **Dome** roof type in the **Roofs** window;

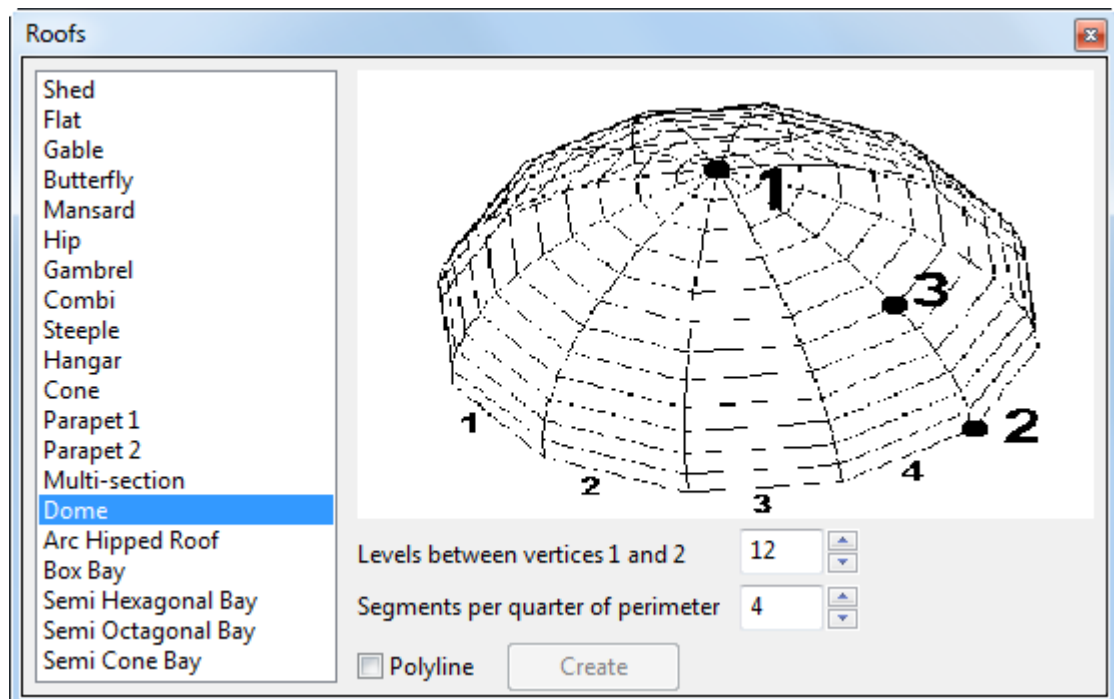

Fig. 60. A dome. Big figures denote the dome's vertices. Small figures are the numerical orders of segments in one of the dome quarters (4 by default)

5. Set the following options for a dome creation (according to the sketch):
 - **Levels between vertices 1 and 2** – is not less than 2 and not more than 100;
 - **Segments per quarter of perimeter** – is not less than 1 and not more than 100.

- To complete dome creation, set the **Polyline** checkbox and click the **Create** button.

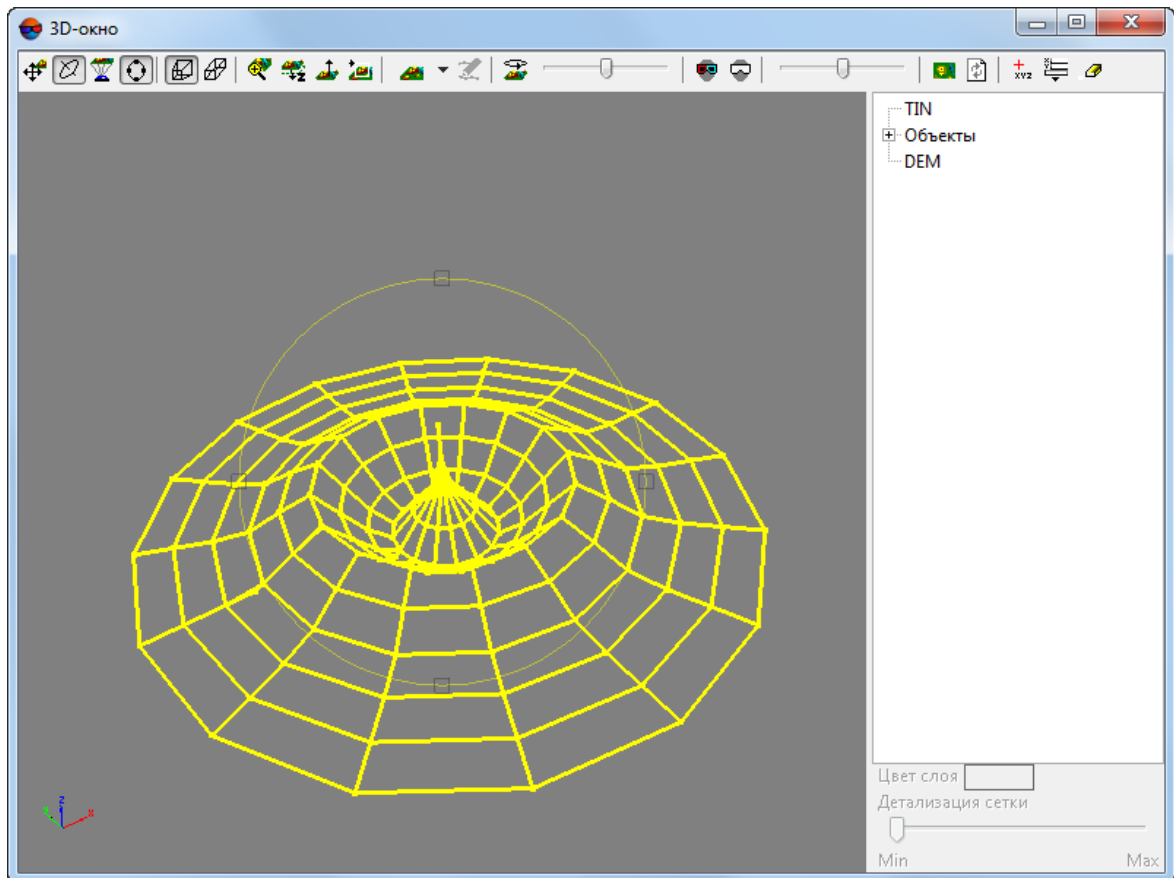

Fig. 61. A shaped dome created manually

Arc hipped roof creation

To create an arc hipped roof, perform the following:

- Open a stereopair and turn on [stereovectorization mode](#);
- Choose **Arc hipped roof** in the **Roofs** window;

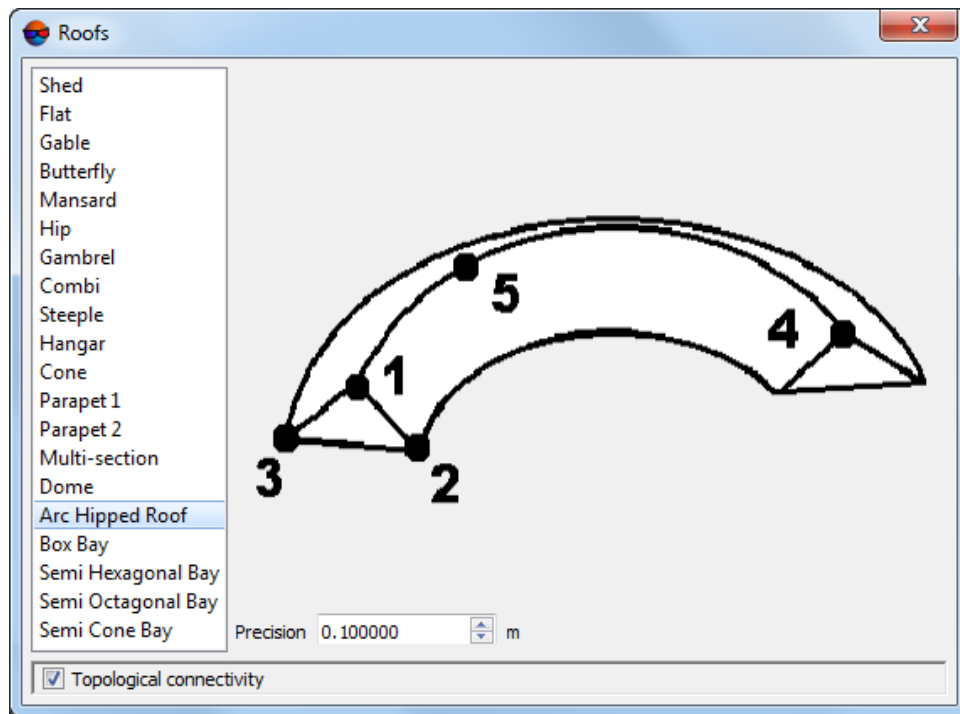

Fig. 62. Arc hipped roof

3. Set the **precision** of roof construction in meters;
4. Sequentially moving the marker in the XY plane and along the Z-axis and pressing the **Insert** button, create vertices that define the position and size of the roof according to the order in the sketch (figures 1, 2, 3, 4, and 5). After entering the 5th vertex, the construction of an arc hipped roof is complete.

Box bay creation

To create a box bay, perform the following:

1. Open a stereopair and turn on [stereovectorization mode](#);
2. Choose **Box bay** in the **Roofs** window;

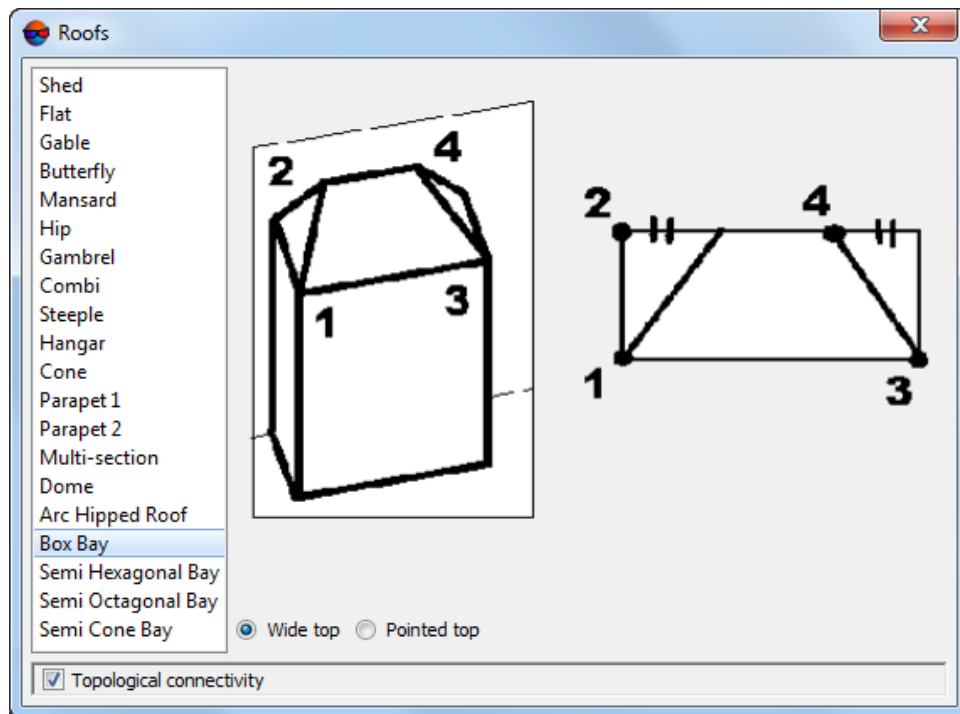

Fig. 63. A box bay (Wide top)

3. Choose the **box bay** type:

- **Wide top.** Sequentially moving the marker in the XY plane and along the Z-axis and pressing the **Insert** button, create vertices that define the position and size of the bay according to the order in the sketch (figures 1, 2, 3, and 4).
 1. Enter the first vertex to start a bay construction;
 2. Move the marker in the XY plane to set the bay's width. Change the marker's height to set the height of the bay ridge. Enter the second vertex;
 3. Move the marker in the XY plane to set the bay's length. The bay is displayed as gray polygons. Enter the third vertex;
 4. Move the marker in the XY plane to set the width of the bay's ridge (widths of equal line segments marked with two dashes in the sketch). Press **Insert** to complete the bay construction.
- **Pointed top.** Sequentially moving the marker in the XY plane and along the Z-axis and pressing the **Insert** button, create vertices that define the position and size of the bay according to the order in the sketch (figures 1, 2, 3, and 4);
 1. Enter the first vertex to start a bay construction;

2. Move the marker in the XY plane to set the bay's width. Change the marker's height to set the height of the bay spire. Enter the second vertex;
3. Move the marker in the XY plane to set the bay's length. The bay is displayed as gray polygons. Enter the third vertex;
4. Enter the last vertex to complete the bay construction.

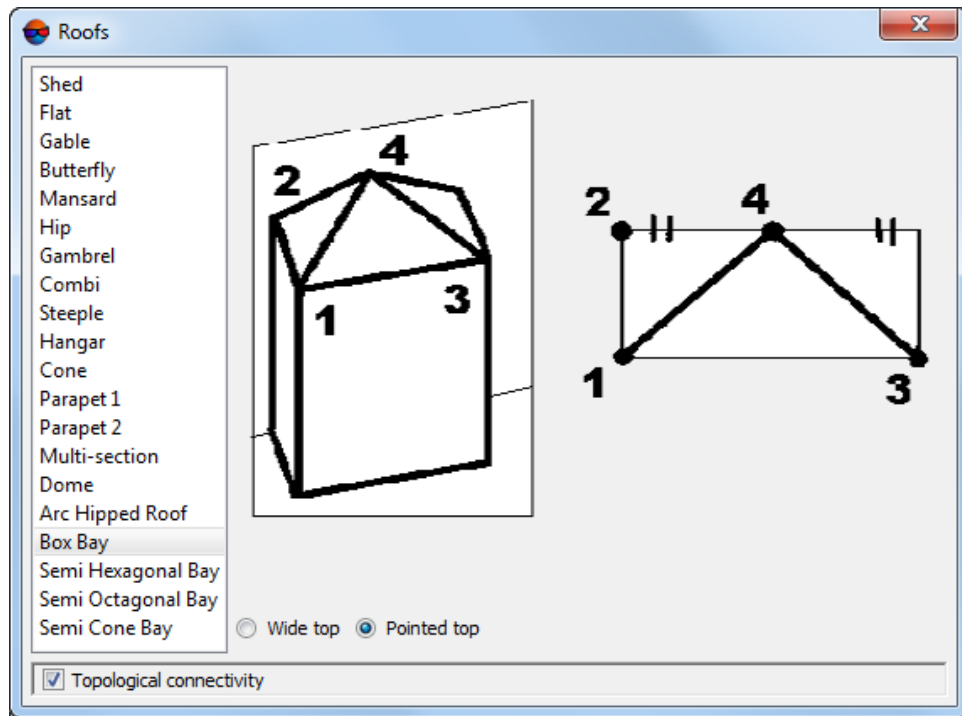

Fig. 64. A box bay (Pointed top)

Semi hexagonal bay creation

To create a semi hexagonal bay, perform the following:

1. Open a stereopair and turn on [stereovectorization mode](#);
2. Choose **Semi hexagonal bay** in the **Roofs** window;

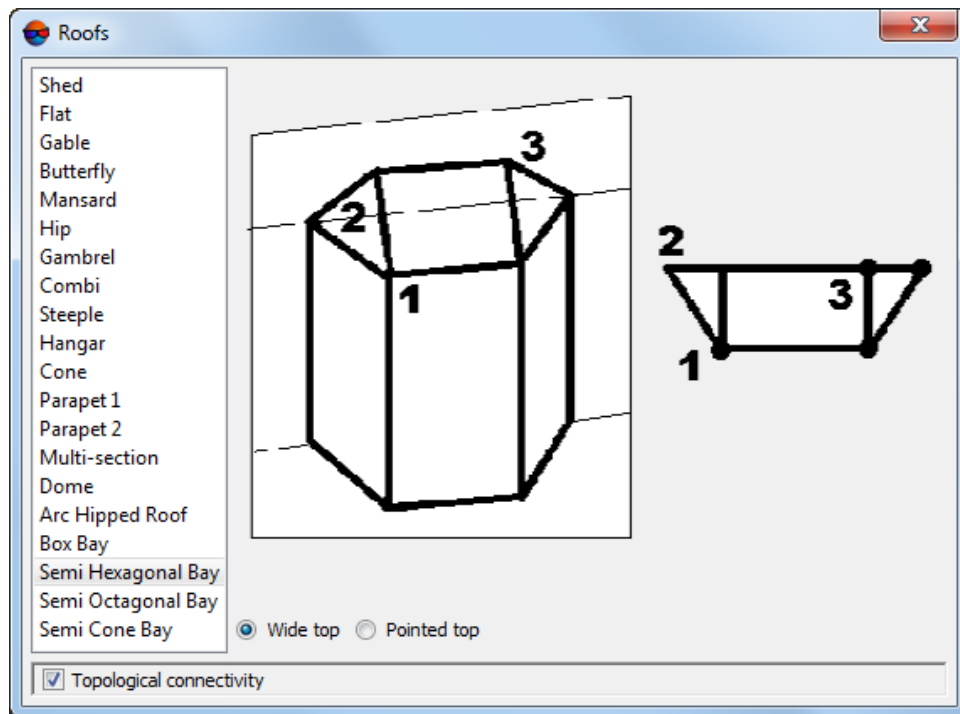

Fig. 65. Semi hexagonal bay (Wide top)

3. Choose the bay type:

- **Wide top.** Sequentially moving the marker in the XY plane and along the Z-axis and pressing the **Insert** button, create vertices that define the position and size of the bay according to the order in the sketch (figures 1, 2, and 3);
 1. Enter the first vertex to start a bay construction;
 2. Move the marker in the XY plane to set the bay's width. Change the marker's height to set the height of the bay ridge. Enter the second vertex;
 3. Move the marker in the XY plane to set the bay's length (and adjust its width as needed). The bay is displayed as gray polygons. Enter the third vertex to complete the bay construction;

- **Pointed top.** Sequentially moving the marker in the XY plane and along the Z-axis and pressing the **Insert** button, create vertices that define the position and size of the bay according to the order in the sketch (figures 1, 2, and 3);
 1. Enter the first vertex to start a bay construction;
 2. Move the marker in the XY plane to set the bay's width. Change the marker's height to set the height of the bay spire. Enter the second vertex;

3. Move the marker in the XY plane to set the bay's length (and adjust its width as needed). The bay is displayed as gray polygons. Enter the third vertex to complete the bay construction;

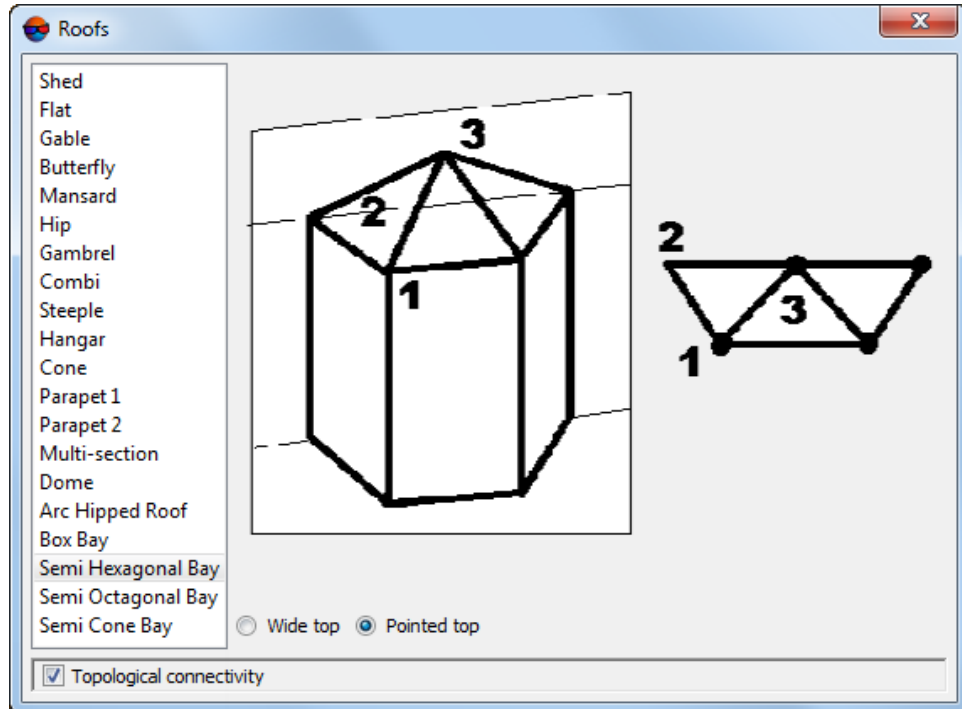

Fig. 66. Semi hexagonal bay (Pointed top)

Semi octagonal bay creation

To create a semi octagonal bay, perform the following:

1. Open a stereopair and turn on [stereovectorization mode](#);
2. Choose **Semi octagonal bay** in the **Roofs** window;

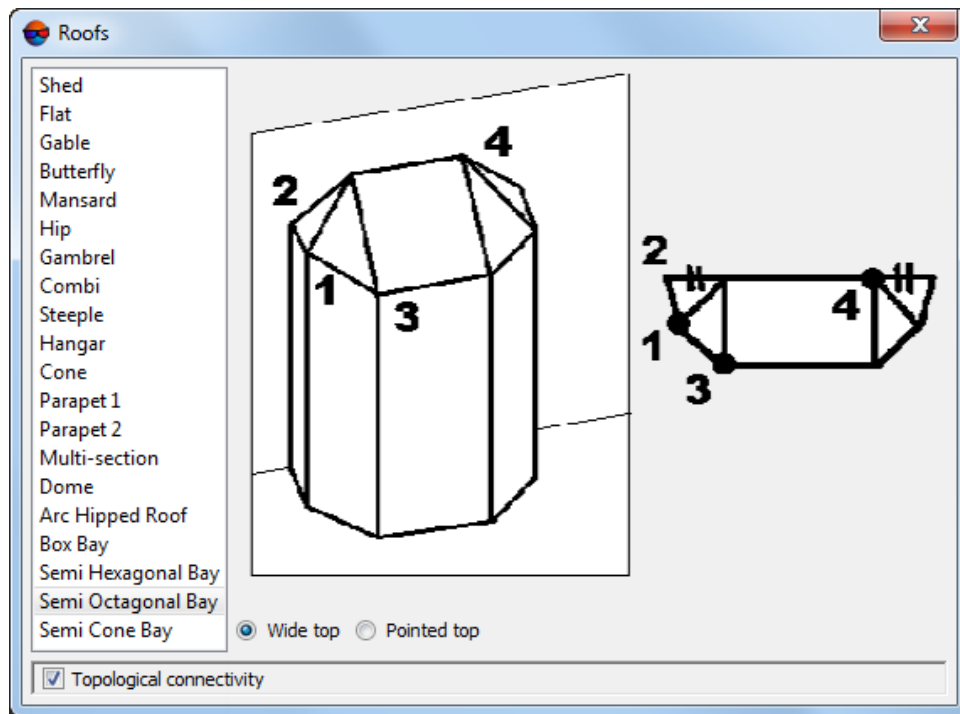

Fig. 67. Semi octagonal bay (Wide top)

3. Choose the bay type:

- **Wide top.** Sequentially moving the marker in the XY plane and along the Z-axis and pressing the **Insert** button, create vertices that define the position and size of the bay according to the order in the sketch (figures 1, 2, 3, and 4);
 1. Enter the first vertex to start a bay construction;
 2. Move the marker in the XY plane to set the bay's width. Change the marker's height to set the height of the bay ridge. Enter the second vertex;
 3. Move the marker in the XY plane to set the bay's width. Enter the third vertex;
 4. Move the marker in the XY plane to set the bay's length. The bay is displayed as gray polygons. Press **Insert** to complete the bay construction.
- **Pointed top.** Sequentially moving the marker in the XY plane and along the Z-axis and pressing the **Insert** button, create vertices that define the position and size of the bay according to the order in the sketch (figures 1, 2, 3, and 4);
 1. Enter the first vertex to start a bay construction;
 2. Move the marker in the XY plane to set the bay's width. Change the marker's height to set the height of the bay spire. Enter the second vertex;

3. Move the marker in the XY plane to set the bay's length. Enter the third vertex;
4. Move the marker in the XY plane to set the bay's length. The bay is displayed as gray polygons. Press **Insert** to complete the bay construction.

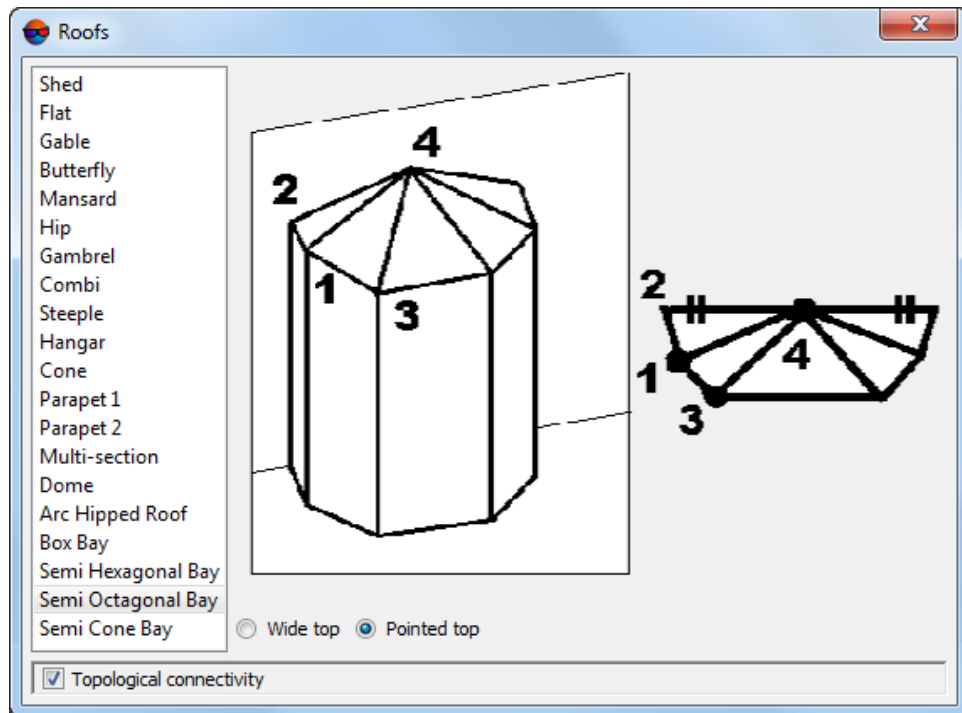

Fig. 68. Semi octagonal bay (Pointed top)

Semi cone bay creation

To create a semi cone bay, perform the following:

1. Open a stereopair and turn on [stereovectorization mode](#);
2. Choose **Semi cone bay** in the **Roofs** window;

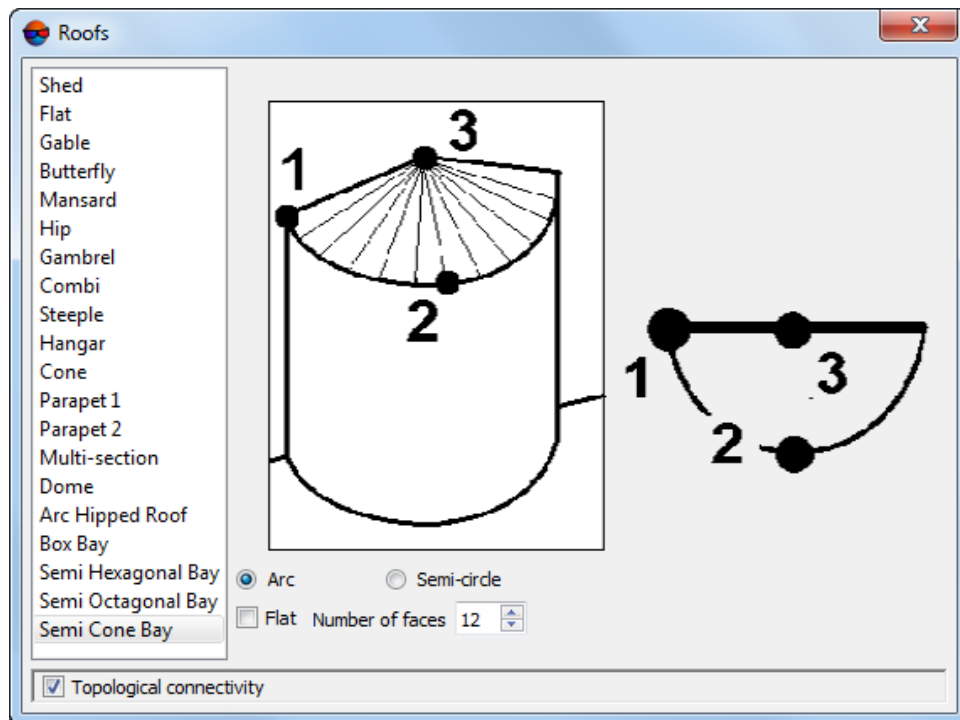

Fig. 69. Semi cone bay (arc)

3. [optional] To create a flat bay, set the appropriate checkbox;
4. Set the **number of faces** between 3 and 100;
5. Choose the bay type:
 - **Arc.** Sequentially moving the marker in the XY plane and along the Z-axis and pressing the **Insert** button, create vertices that define the position and size of the bay according to the order in the sketch (figures 1, 2, and 3);
 1. Enter the first vertex to start a bay construction;
 2. Move the marker in the XY plane to set the bay's width. Enter the second vertex;
 3. Move the marker in the XY plane to set the bay's length. Change the marker's height to set the height of the bay, if it is not **flat**. Enter the third vertex to complete the bay construction.
 - **Semi-circle.** Sequentially moving the marker in the XY plane and along the Z-axis and pressing the **Insert** button, create vertices that define the position and size of the bay according to the order in the sketch (figures 1 and 2);
 1. Enter the first vertex to start a bay construction;

2. Move the marker in the XY plane to set the bay's size. Change the marker's height to set the height of the bay, if it is not **flat**. Enter the second vertex to complete the bay construction.

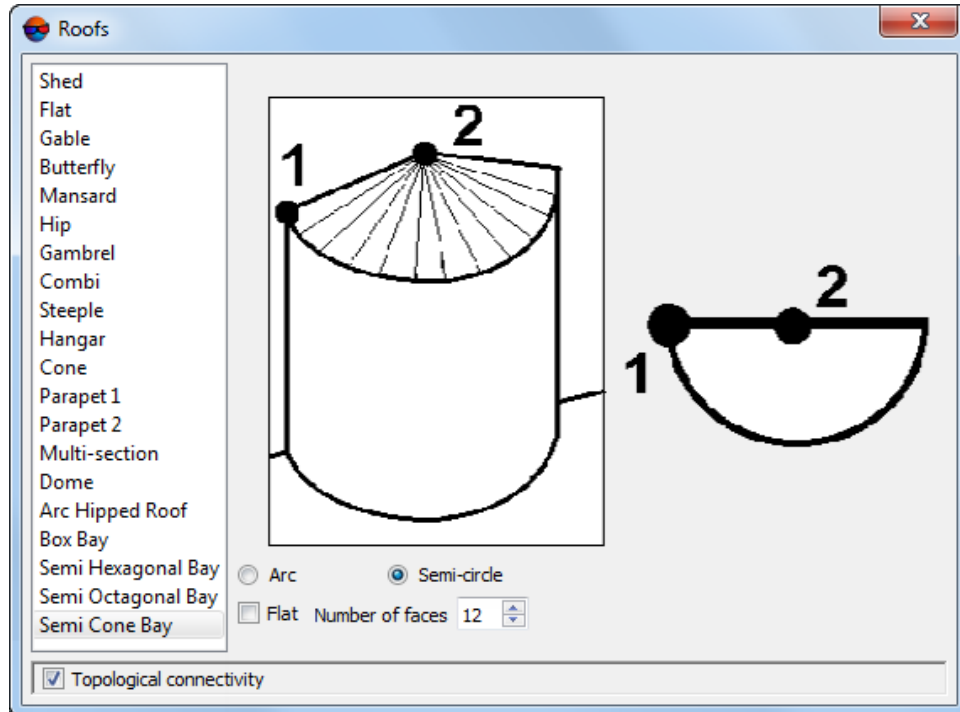

Fig. 70. Semi cone bay (semi-circle)

5.3.7. Building height calculation

In certain circumstances, the system allows to measure a building height using a simple vector polygon that delineates the lower boundary of a building's roof. The obtained value of building height (from the building's foot to the roof's boundary) can be in its turn used further in different ways. For example, during further, more detailed vectorization of the abovementioned roof, this height value can be attributed manually to vector vertices delineating the lower boundary of the building's roof (see the [previous chapter](#)).

The system allows to measure building heights in two ways:

- **Calculate by wall;**
- **Calculate by shadow.**







Building height measuring is available only for an adjusted project. The measuring accuracy greatly depends on initial data quality and geometric parameters of the imaging of each single object.

To **calculate by shadow** is possible only for an adjusted satellite scanner imaging project. Metadata of initial images of the mentioned project must contain the values of the Sun elevation angles at the time of survey, acceptable in accuracy.

To **calculate by wall** is possible both for scanner projects and central projection projects assuming that the off-nadir angle was obtained from metadata (which is usually always the case for most central projection projects).

To measure building heights, perform the following:

1. Choose **Rasters › Show rasters › Source only**;
2. [optional] Enable one of the modes of **snapping** to vertices;
3. To open the **Orthorectification** toolbar, click the  button of the main toolbar;
4. Open one of project images in a separate window by clicking ,  or  buttons of the **Orthorectification** toolbar;
5. Click the  button of the **Orthorectification** toolbar and choose the data source, which is a vector layer that contains (or will contain) polygons delineating lower boundaries of building roofs:

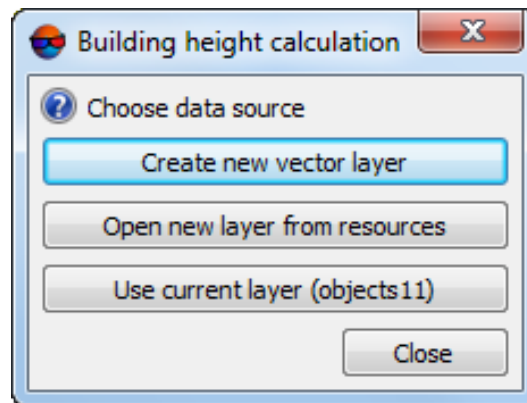

Fig. 71. Choosing vector data source

6. The **Building height calculation** window opens:

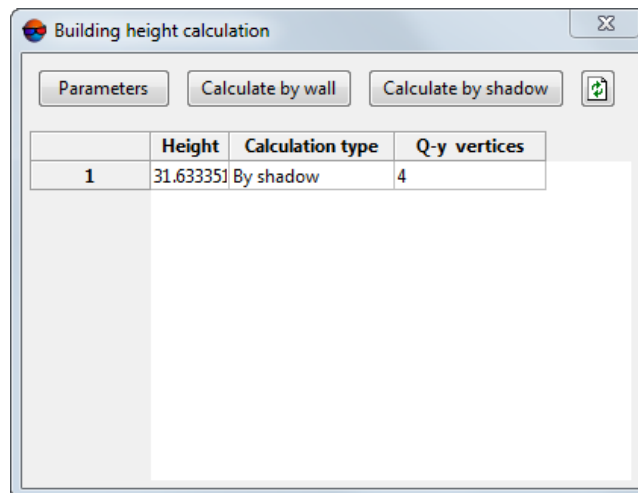



Fig. 72. The Building height calculation window

The **Building height calculation** contains the following elements:

- A button allowing to set **Parameters** of building height calculation;
- **Calculate by wall** and **Calculate by shadow** buttons that allows to enable appropriate calculation modes (see below);
- The  button allowing to update window contents (see below);
- A table containing the calculation results (after performing at least one calculation). The number of lines in the table is equal to the number of polygons in the vector layer chosen at the step 5 (if an empty vector layer is chosen/created, it is needed to create polygons delineating building roof boundaries).



The  button allows to update the table contents after working with vector polygons.

This table includes the following columns:

- A numerical number of a polygon (roof) / height calculation (one calculation is available for each polygon);
- Calculated **height**;
- **Calculation type** (see above);
- **Q-ty vertices** – the number of polygon vertices.

After the calculation, the **Height** and **Calculation type** (optional) are also written/rewritten into the [attributes](#) of the vector polygon for which the measurement was made (see below).

7. [optional] to set the **Parameters** of building height calculation, click the appropriate button. The **Height calculation parameters** window opens:

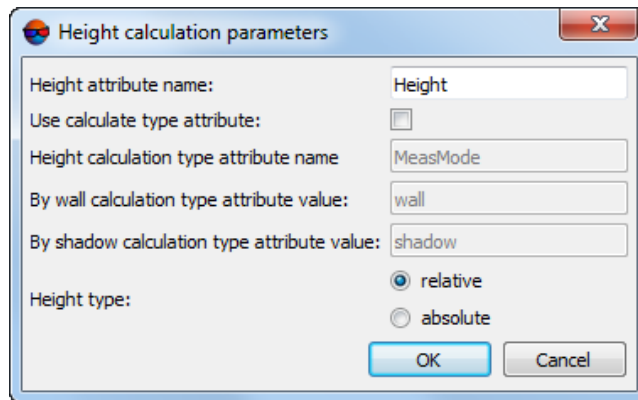

Fig. 73. The “Height calculation parameters” window

Set the following parameters:

- **Height attribute name**, that appears for the appropriate polygon after the first calculation;
- [optional] set the **Use calculation tape attribute** checkbox in order to additionally record the calculation method in the attributes of the abovementioned polygon, and set the following parameters:
 - **Height calculation type attribute name**;
 - **By wall calculation type attribute value**;
 - **By shadow calculation type attribute value**.
- Choose **Height type**:
 - **relative** height of the object (building) itself from the foot to the roof’s boundary;
 - **absolute** height of the lower boundary of building roof in the project’s coordinate system according to the current terrain model (see the **Type of DTM** tab in the **Orthorectification parameters** window).



To open the **Orthorectification parameters** window, click the  button of the **Orthorectification** toolbar.

To close the **Height calculation parameters** window, click OK.

For direct building height calculation, perform the following:

8. Choose a building to be measured. The building's shadow, roof, bottom, and wall are to be clearly seen in the image under processing (see the picture below).



Choose **Rasters** > **Show rasters** > **Source only**, if not done yet.

9. [optional] Create a vector polygon that delineates the building's roof boundary, if not done yet.

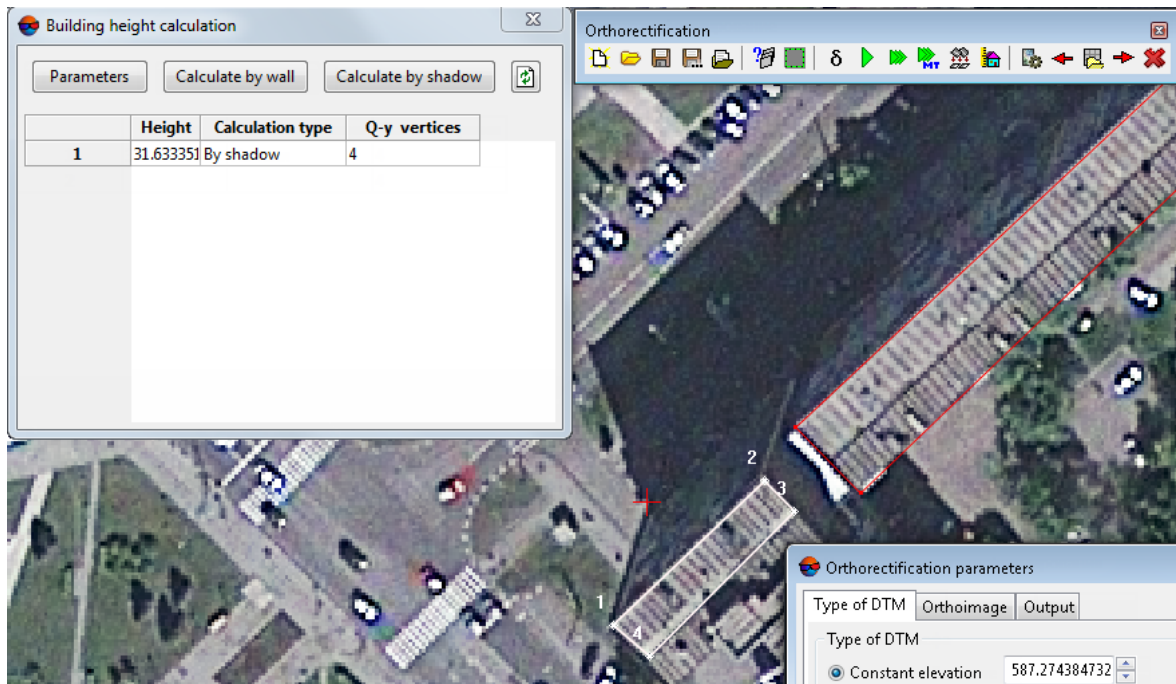

Fig. 74. The selected polygon delineates a flat roof of a multistore building, the shadow and sheer wall are clearly seen. The marker is at the building's foot (ground level, if the **relative** height is calculated; otherwise, **absolute** building height will be calculated, according to the current terrain model – see the **Type of DTM** tab in the **Orthorectification parameters** window).

10. [optional] To calculate the building height **by wall**, perform the following:
- Move the marker as accurately as possible to the foot of the building so that it is located vertically below one of the vertices of the polygon delineating the building's roof boundary (see the pictures - it is recommended to make calculations along building edges, if applicable);
 - Select the abovementioned polygon;
 - To enable this height calculation mode, click the **Calculate by wall** button in the **Building height calculation** window, (colored button border means that the mode is turned on);

- Move the marker to the polygon vertex where it was initially at the building foot (enabled one of the modes of **snapping** to vertices is recommended):

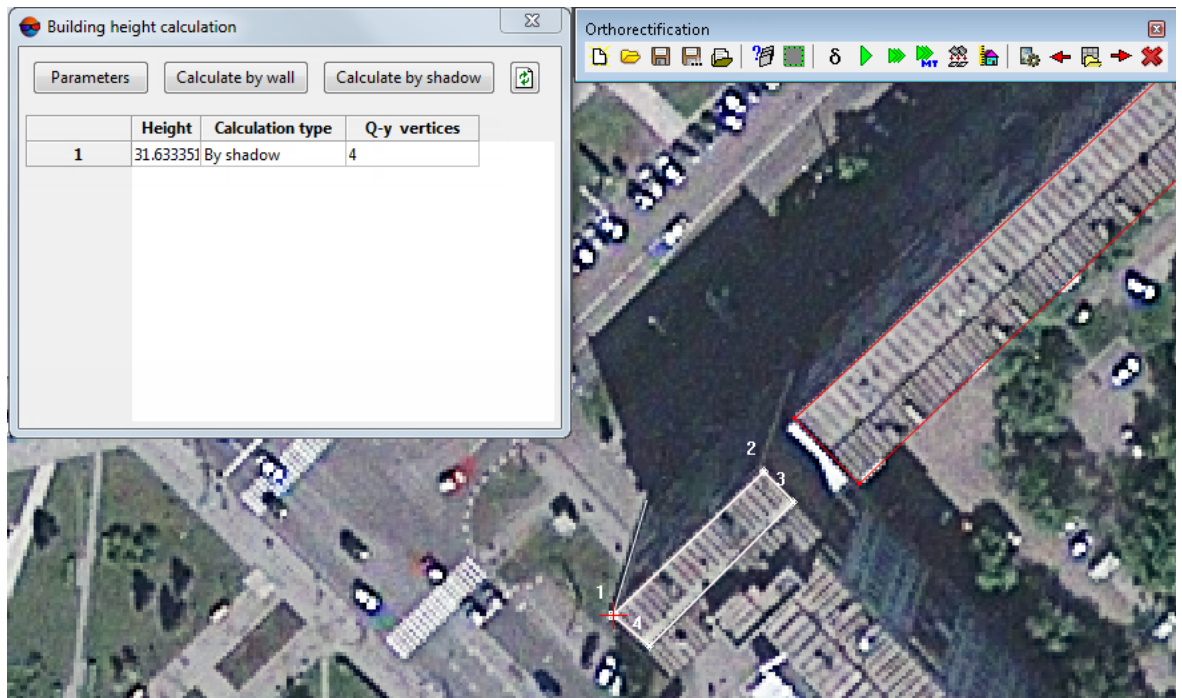

Fig. 75. Moving the marker from the building's foot to the polygon vertex (roof boundary).

- Press **Enter**. If successful, calculated **Height** and **Calculation type** are recorded into the appropriate table row in the **Building height calculation** window (the appropriate attributes of the selected vector polygon are also created according to the parameters set in item 7). Otherwise, a message about an error of height calculation appears.

11. [optional] To calculate the building height **by shadow**, perform the following:

- Move the marker as accurately as possible to the foot of the building so that it is located vertically below one of the vertices of the polygon delineating the building's roof boundary (see the pictures);
- Select the abovementioned polygon;
- To enable this height calculation mode, click the **Calculate by shadow** button in the **Building height calculation** window (colored button border means that the mode is turned on);
- Move the marker to the border of the building shadow, focusing on the selected vertex, vertically below which the marker was originally located, placed at the foot of the building (see the picture below):

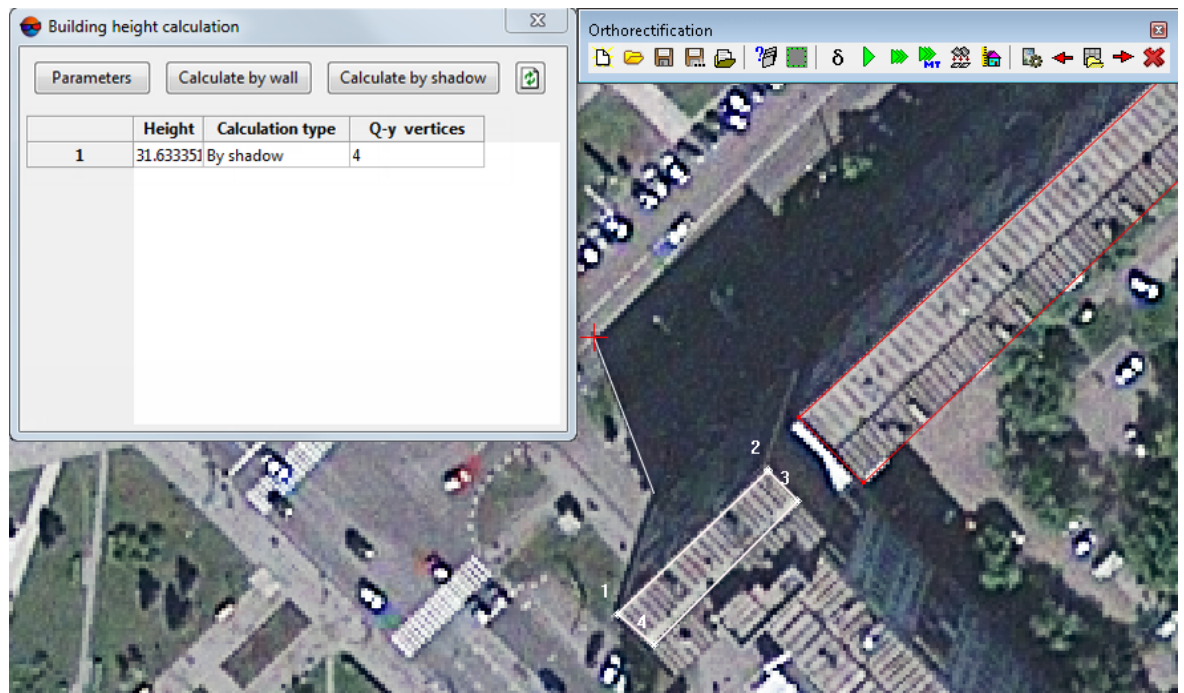

Fig. 76. Moving the marker from the building foot to the shadow boundary

- Press **Enter**. If successful, calculated **Height** and **Calculation type** are recorded into the appropriate table row in the Building height calculation window (the appropriate attributes of the selected vector polygon are also created according to the parameters set in item 7). Otherwise, a message about an error of height calculation appears.

5.3.8. Vector object properties

To display linear vector object properties, select the object and choose **Vectors** › **Polyline properties** or use the **I** hotkey. The **Object properties** window contains the following parameters of 2D-object:

- number of vertices;



If there were selected several vector objects, the number of selected linear vector objects is displayed in the **Vertices number** field.

- maximal and minimal object coordinates separately and for each axes;
- length/perimeter;



If there were selected several vector objects, the sum of lengths/perimeters of selected linear vector objects is displayed in the **Length/Perimeter** field.

- plain area (in case of polygon) – in project *coordinate system* or *on the reference surface*;

 *Reference surface* (during baseline measurements) – level surface that coincides with the sea-level surface and is used for reducing the measurement results on the physical surface of the Earth.

 A value of the area *on the reference surface* is calculated only when using *global* working coordinate system.

 If there were selected several vector objects, the sum of areas of selected polygons is displayed in the **Object properties** window.

- length of polyline or length of polygon boundary projected on plane.

In the **Object vertices** section is displayed the list with numbers and coordinates (XYZ) of selected object vertices. The vertices are numbered in the order they were created during vectorization.

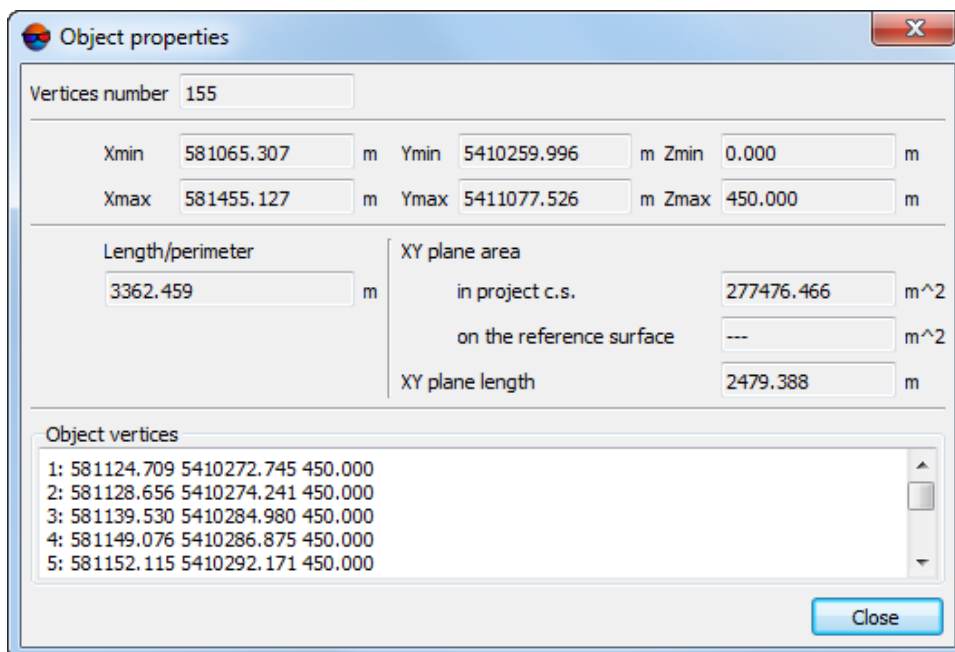

Fig. 77. The Object properties window

5.4. Vector objects loading

In order to load vector objects perform the following actions:

1. Choose **Vectors** > **Load** or click the  button of the main toolbar.

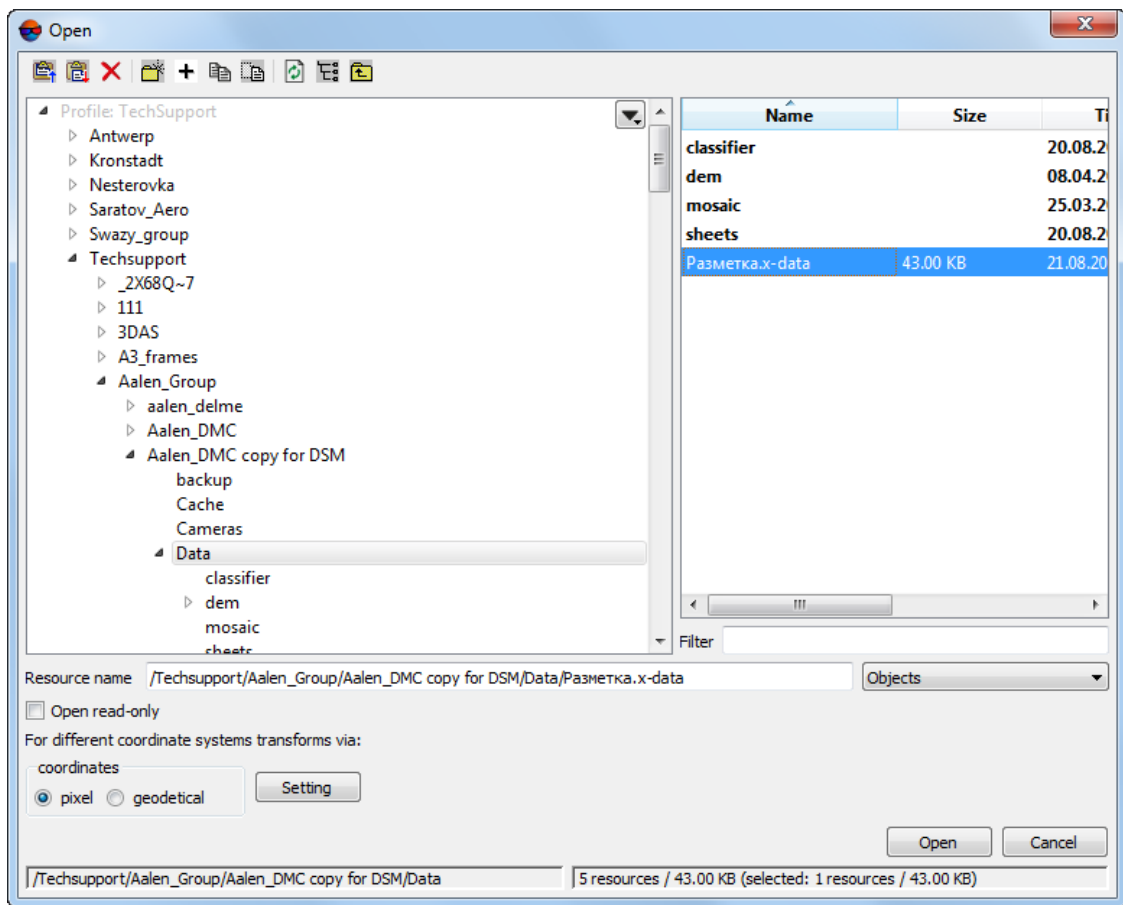

Fig. 78. Vector layer loading

2. Select one or multiple vector files with *.x-data or *.cx-data extension.



After that when multiple files are selected the system suggests two ways of loading: to load all in the same layer or to load each file in a separate layer.

3. [optional] To disable saving and rewriting of selected file, set the **Open read only** checkbox on.
4. [optional] Select method of objects coordinates recalculation **For different coordinate systems transforms via** – using pixel or geodetic coordinates (see details in the “[General system’s parameters](#)” User Manual).
5. Click the **Open** button. If one or multiple vector layers are already loaded to active project, then during loading of new vector layer the window of loading type is opened.

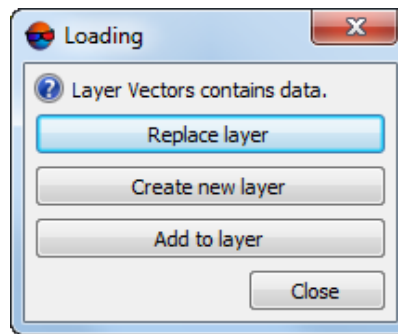

Fig. 79. Vector layer loading

The system provides the following variants of new layer loading to existing vector layer:

- **Replace layer** – vector data of active layer is replaced by data from loading layer;
- **Create new layer** – vector data is loaded to a new layer;
- **Add to layer** (without unloading existing data) – during loading vector data is added to objects of active vector layer.

When it is necessary to load two or more vector files at once, there is the following ways of loading:

- **Clear layer and load all files into it** – vector data of active layer is replaced by data from loading layers;



First, make sure that important data will not be lost during the replacement process, especially if the active layer is [co-edited](#) by several users.

- **Load all into one new layer** – vector data is loaded to a single new vector layer;



The system provides for combined data loading both from ordinary and [co-editable](#) vector layers (with *.x-data and *.cx-data extensions, respectively). However, the active vector layer created as a result of such an operation will not be co-editable. The co-editing functionality can only be available for a vector layer already saved in the active profile resources (see [Section 4](#)).

- **Create separate layer for each file** – vector data of each file are loaded to separate layers;
- **Load all layers into Vectors without unloading existing data** – vector data of all files adds to objects of active vector layer.

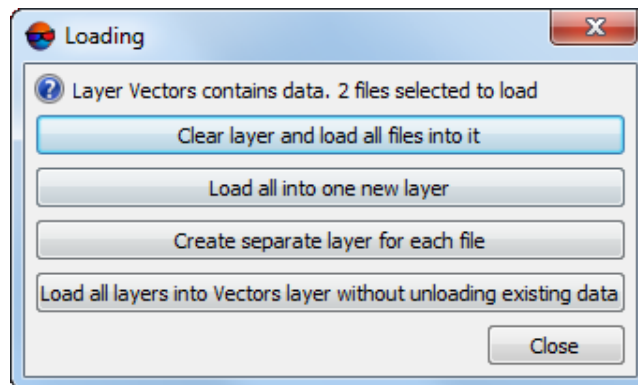

Fig. 80. Vector layer loading

Vector layers are displayed in Manager.

If vector data layer is saved to different coordinate system or in a project with different adjustment results, the system recalculates coordinates automatically. After loading produces information message about coordinates recalculation.

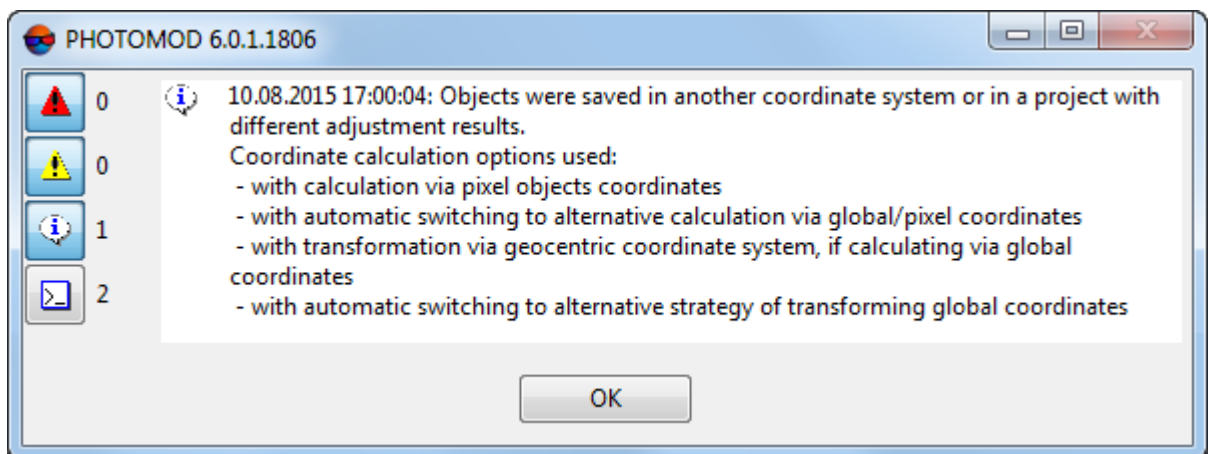

Fig. 81. Coordinates recalculating during vector layer loading

The system provides a possibility of quick access to recently loaded vector data files. To do this use the **Vectors** › **Recent** menu item. If necessary, the default coordinates recalculation uses.

To close a vector layer, select **Vectors** › **Close**. To close all vector layers, select **Vectors** › **Close all opened layers**.

5.5. Vector objects saving

To save (or rewrite) active vector data layer select **Vectors** › **Save** or click the layer name by mouse right button in the *Manager* and choose the **Save** in context menu.

To save active layer with new name select **Vectors** › **Save as** or click the layer name by mouse right button in the *Manager* and choose the **Save as** in context menu, specify file name and path in active profile resources.

To save just selected vector objects, select all vector objects that should be saved and select **Vectors** › **Save selected as**. After that vector objects are still associated with classifier.

The **Vectors** › **Recent** menu item allows to load the last saved version of active vector layer.

5.6. Displaying objects list

The system provides possibility to show list of active layer objects and their parameters.

Choose **Window** › **Objects list**. The **Objects list (Total objects)**.

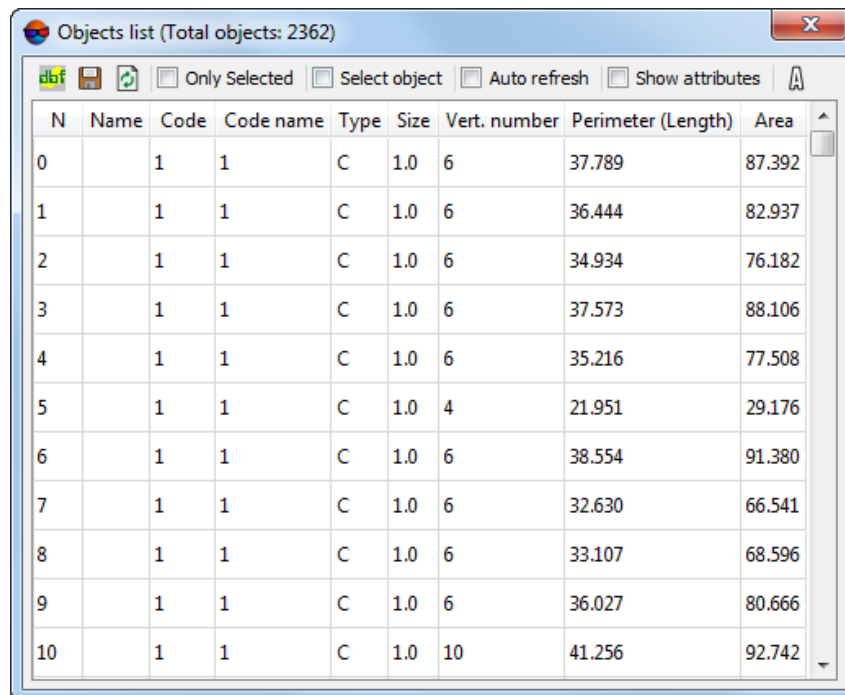

N	Name	Code	Code name	Type	Size	Vert. number	Perimeter (Length)	Area
0		1	1	C	1.0	6	37.789	87.392
1		1	1	C	1.0	6	36.444	82.937
2		1	1	C	1.0	6	34.934	76.182
3		1	1	C	1.0	6	37.573	88.106
4		1	1	C	1.0	6	35.216	77.508
5		1	1	C	1.0	4	21.951	29.176
6		1	1	C	1.0	6	38.554	91.380
7		1	1	C	1.0	6	32.630	66.541
8		1	1	C	1.0	6	33.107	68.596
9		1	1	C	1.0	6	36.027	80.666
10		1	1	C	1.0	10	41.256	92.742

Fig. 82. Objects list

The window displays the table containing the following columns:

- **N** – the object's number;
- **Name** – a unique object name (see [Section 6](#));
- **Code** – a code in classifier, to which the object is assigned (see [Section 6](#));

- **Code name** – a code name in classifier, to which the object is assigned (see [Section 6](#));
- **Type** – object type: P – point, L – polyline, C – polygon (see [Section 6](#));
- **Size** – real number, which describes the size of a vector object used in a real system of coordinates; for points this parameter determines the size of the characters, that display them on the image (see [Section 6](#));
- **Vert. number** – vertices number;
- **Perimeter (Length)** – length, in measurement units of current project (for the polylines) or perimeter (for the polygons).
- **Area** – area, in measurement units of current project (for the polygons).



The area measurement is available only for the polygons without self-intersections.



To sort objects in the table by data of column, click on the name of this column. This function is also available for the columns, containing an object's attributes.

If the **Auto refresh** checkbox is set on, table refresh automatically after any changes of objects on active layer.

The **Show attributes** checkbox allows to show in the table attributes of all layer objects. To show attribute click the  button after the checkbox is set on.



The system provides for editing object attributes not only in the **Object attributes** window, but also directly in the table of **Objects list** window.

When the **Select object** checkbox is set on, an object selected in the table is highlighted in 2D-window, marker is placed to the first vertex of the object (in case of polylines and polygons), and the screen is centered by marker.







To show only selected objects in a table, set the **Only selected** checkbox, select required objects and click the  button.

Table 6. Overview of the Objects list window toolbar

Buttons	Function
	to save the list of objects to *.dbf file format
	to save the list of objects to *.txt file format
	to refresh window manually
	to open the Object attributes window (for this, first select an object by setting the Select object checkbox in the Objects list window or by selecting the object in the 2D window).

The saved () *.txt-file containing the **Objects list** completely duplicates the structure of the table described above. The first line contains column names, the following lines

contain the table cell values. The semicolon (;) sign is used as a delimiter, the dash (-) is used for empty values. Cell values that initially contain a semicolon are enclosed in quotation marks ("").

6. Classifier

6.1. The “Classifier” window

The classifier is a set of standard attributes, used for thematic objects classification.

All vector objects created in the classifier layer, are assigned to one of classifier’s record.

The system allows to create, edit, import and export a classifier. The **Classifier** window is used for this purpose.

Classifier is a tool to systematize vector objects. For example, during work with classifier there is a possibility to highlight all objects with the same code, delete them or display different objects classes using different colors.

 Vector objects codes are used for [vectors export](#) to different exchange formats.

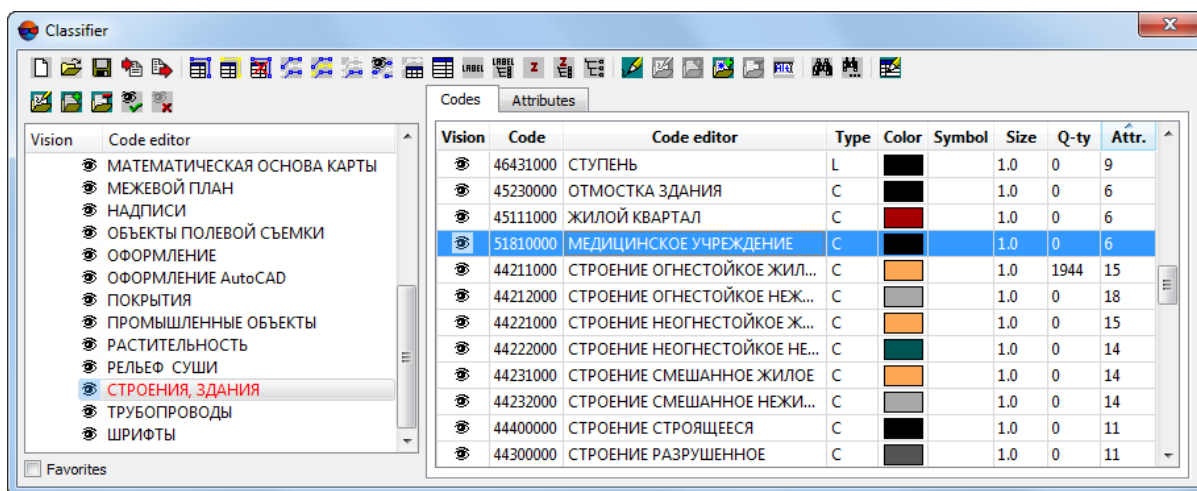





























Fig. 83. The Classifier window

The left part of the window contains a list of project thematic layers, the right part – a table of vector objects codes, and includes three tabs: **Codes** and **Attributes**.

Table 7. Overview of the Classifier window toolbar

Buttons	Function
	to close opened classifier and create a new one (see Section 6.2)
	to open created classifier
	to save changes to a classifier

Buttons	Function
	to open a window used to select a file to import codes to active classifier
	to open a window used to select a file to export codes to Panorama format with *.rsc extension
	to change a code of object selected in 2D-window (see Section 6.6 и Section 6.7)
	to assign a code to all non-assigned objects of the same type (see Section 6.6 and Section 6.7)
	to select all objects with this code (see Section 8.2.3)
	to select all un-assigned objects (see Section 8.2.3)
	to select all objects of the code group (see Section 8.2.3)
	to select all visible objects of the layer, except for those with disabled visibility (to disable object's visibility, click the  button to the left from a codename or a word); is used for batch export of all selected objects
	to display codes of vector object in a classifier when it is selected in 2D-window
	to scroll the codes list to selected code
	to set a note for active code (see Section 6.5)
	to set a note for all codes of a layer (see Section 6.5)
	to assign height values to object vertices, if after import these values were added to a classifier attributes (is used to import contour lines from MIF/MID and SIT formats, see Section 13.11))
	to assign height values to vertices of all objects, if after import these values were added to a classifier attributes (is used to import contour lines from MIF/MID and SIT formats, see Section 13.11))
	to display in the codes list all codes of vector objects, that belong to the selected layer
	to enable classifier editing mode (see Section 6.3)
	to open window used for editing of selected code or attribute (see Section 6.3)
	to open window used for creation of new code or attribute (see Section 6.3)
	to add selected code to a separate list of codes, that is used for easy search for frequently used codes. To display the list set the Favourites checkbox in the left lower part of the Classifier window
	to delete selected code or attribute from the classifier
	to assign selected hotkeys (Shift+1,2,3,4,5) to active vector object code, and to use them for code quick code display in classifier
	to search string By code or By code name0
	to perform further search for records in selected mode
	to load existing classifier during creation of a new layer with classifier by default

The **Attributes** tab in a classifier is used to create and edit attribute information.

On the **Codes** tab there is a table of classifier properties, that contains the following columns:



- **Visible** – shows visibility of the objects with selected codes in 2D-window;

- **Code** – an object code;
- **Name** – arbitrary text, unique name, for example, “Earth roads”;
- **Type** – object type: P – point, L – polyline, C – polygon (see [Section 6.2](#));
- **Color** – a color of object display;
- **Symbol** – ASCII symbol corresponding to objects code, is used for point objects and is selected from the symbols list in existing library;
- **Size** – real number, which describes the size of a vector object used in a real system of coordinates; for points this parameter determines the size of the characters, that display them on the image;
- **Q-ty** – number of objects with specified code;
- **Attr.** – number of object’s attributes (see [Section 7.2.1](#)).

To sort lines in the **Code**, **Name**, **Type** or **Q-ty** columns click on column name.

If the  to the left from the layer name or object code is active, objects of active code or layer are displayed in 2D-window.

To switch visibility mode of selected objects or layers in 2D-window, perform one of the following actions:

- click on the  icon to the left from the layer name or object code;
- use the  buttons to show and  button to hide the layer.

6.2. Classifier creation

Perform the following actions for creating a classifier:

1. Load or [create](#) vector layer with classifier.
2. Choose **Window** › **Classifier**. The **Classifier** window opens.



After first creation or loading layer with classifier the **Classifier** window opens automatically.

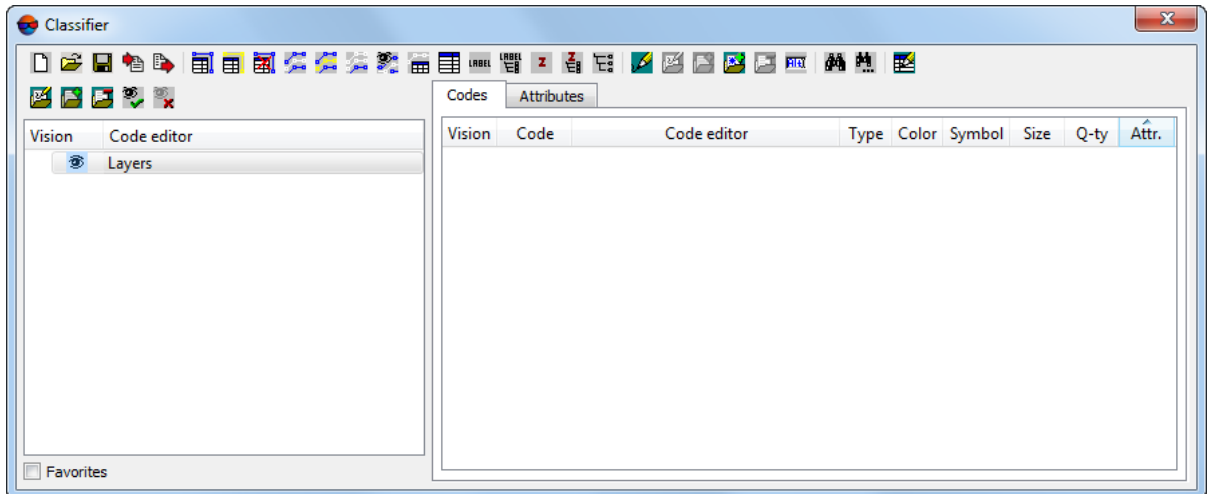



Fig. 84. The Classifier window

3. [optional] To create a new classifier instead of opened one click the  button.
4. Click the  button of the **Classifier** window additional toolbar to create a layer.

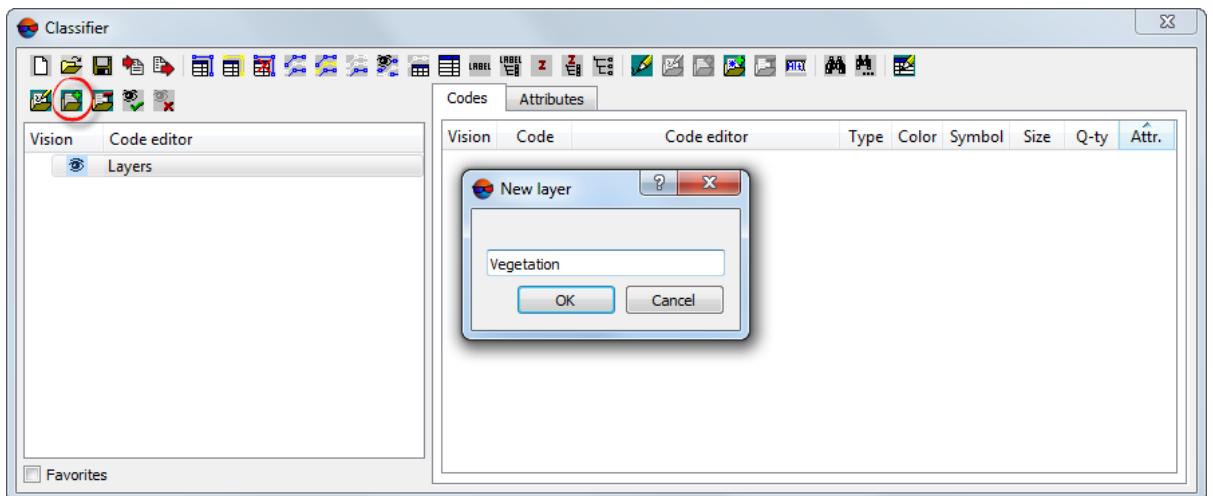



Fig. 85. Creation of layers list in classifier

5. Select layer to create new code.
6. Click the  button to set on the classifier edit mode.
7. Click the  button of the **Classifier** window main toolbar to create a new code in the classifier. The **Add code** window opens.

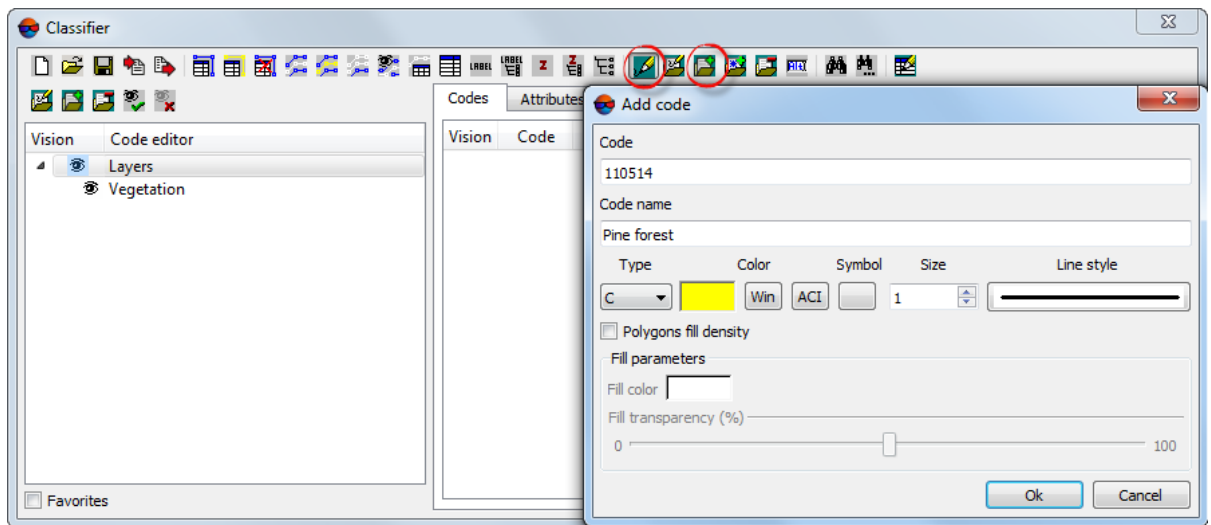

Fig. 86. Creating new code

8. Specify unique object **Code**, for example, its serial number or a numerical code.
9. Specify unique object **Code name**, arbitrary text (for example, "Water object").
10. Select the object **type**:
 - for the point object select its type **P** and define the symbol (from standard symbols library), and symbol's color (from standard color palette of *MS Windows*(the **Win** button) or from *AutoCAD program* palette (the **ACI** button)) and a size (in points in corresponding field).
 - for linear object select its type **L**, for polygon – type **C**; for these objects it is possible to specify a color of line (from standard color palette of *MS Windows* (the **Win** button) or from *AutoCAD program* (the **ACI**) button).
11. [optional] To change line style and size for polylines and polygons click on the **Line style** button.

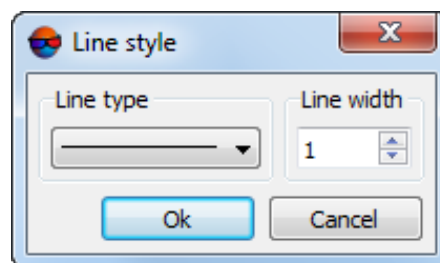

Fig. 87. Select line style



Selected line style is preserved during export of linear objects to DXF and DGN formats (see [Section 14.4](#) and [Section 14.5](#)).

12. [optional] To configure color and transparency of **C** (or **L**) type vector objects set the **Polygons fill** checkbox on. In the **Fill parameters** section define the following settings:

- **Fill color** – is used to select fill color;
- **Fill transparency (%)** – is used to setup fill transparency.



Fill color saves during [import/export](#) in *KML* format.

13. Click OK. Created code is added to the layer, which name is selected in the layers list, id objects are not divided into layers.

In order to save codes and layers classifier click the  button. Define file name and path in active profile resources. During following program launches the classifier is loaded automatically.

To load another classifier click the  button and select a file with classifier in active profile resources. For more details about classifier import see [Section 6.4](#).

To use existing classifier during new layer creation use the  button.

6.3. Classifier editing

In the **Classifier** window there is a possibility to edit a list of layers in the left panel and a list of codes and attributes – in the right one. For more details about attributes list editing see [Section 7.2.1](#).

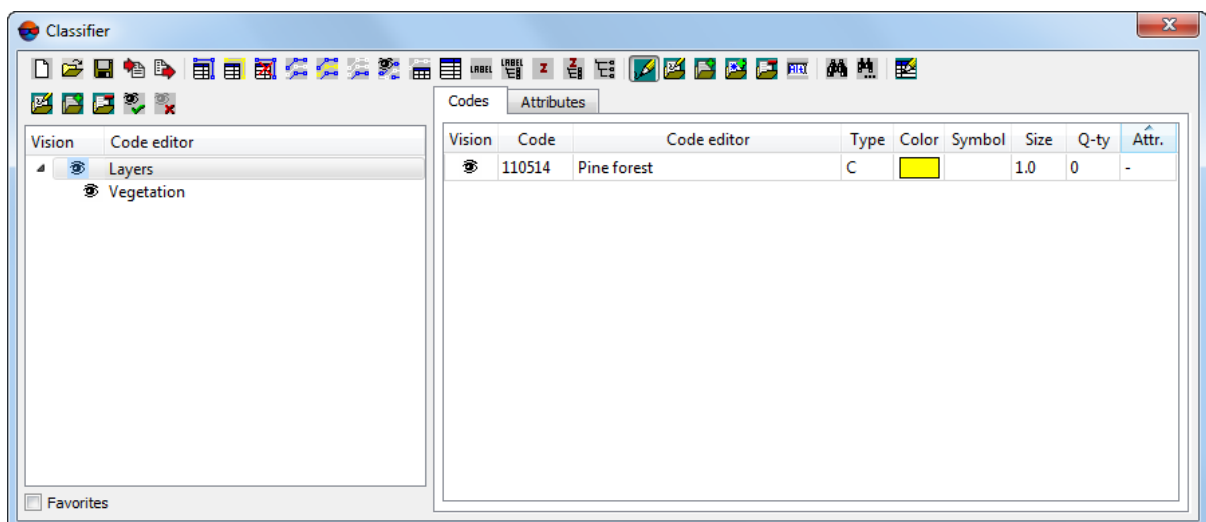













Fig. 88. The Classifier window



Above the **Classifier** window there is an additional toolbar, that includes the following buttons:

-  – allows to change selected layer name (**F2**).
-  To save changes press **Enter**, to cancel editing – **Esc**.
-  – allows to create new classifier layer;
-  – allows to delete selected layer from layers;
-  – allows to display all objects of a layer, including sublayers;
-  – allows to hide all objects of a layer, including sublayers;

To edit classifier it is possible to use the following buttons of the main toolbar of the **Classifier** window:

-  – allows to open the **Code editing** window (see [Section 6.2](#));
-  Change of a code *type* is possible only if a layer does not contain objects of a given code.
-  – allows to open the **Add code** window to input values of each classifier field of a new record;
-  – allows to add selected code to separate codes list, that is used to search for frequently used codes and is displayed, if the **Favourites** checkbox is set on in the left lower part of the classifier window;
-  – allows to delete selected catalogue from layers list with preliminary warning;

Context menu of layer list contains the following menu items:

- **Copy layer** – allows to copy a layer selected in the list to clipboard;
- **Paste layer** – allows to paste a layer from clipboard to the layers list;
- **Move layer** – allows to cut selected layer and it list or inside selected layer (as a sub-layer);
- **Show layer with sublayers** – allows to display in 2D-window objects, which codes belong to the selected layer (when the “eye”  to the left of the layer name is enabled);
- **Hide layer with sublayers** – allows to hide in 2D-window objects, which codes belong to the selected layer (when the “eye”  to the left of the layer name is disabled);

Context menu of code list contains the following menu items:

- **Copy code** – allows to copy a code selected in the list to clipboard;
- **Insert code** – allows to paste a code from clipboard to the codes list;
- **Move code** – allows to paste a code from clipboard to the codes list and to delete it from its previous location;
- **Add code to favourites** – allows to add a code selected in the list to the *Favourites*.

6.4. Classifier import

The system provides possibility of vector objects codes import during creation or updating of active classifier. To import is used the  button.

The system provides import of classifier from the following formats:

- import of a rsc-file to classifier layer. In files with the *.rsc extension the symbols libraries (classifier) are used to display and print digital maps. A set of standard classifiers (files with *.rsc extension) is included to the system delivery package and is stored in the \VectOr\DOC folder after system installation. During import of classifier from *Panorama* a set of standard classifiers is used for correct codes display;
- import of classifier assigned to existing map (files *.sit, *.map) to a code table of layer with classifier.

During import of vector objects to a layer with classifier from supported exchange formats, their codes are also imported to a new classifier or are added to the existing one, depending on settings, see [Section 13](#).

6.5. Labels creation

For vector objects the system provides creation of special label (*label*), that is displayed in 2D-window as a label near point object or near vertex of linear object, depending on settings (see the “[General system’s parameters](#)” User Manual).



Such a label is also displayed next to an object after export to DXF file of the *AutoCAD program* (see [Section 14.5](#)).



Labels creation is performed after creation of all objects and prior to their export to DXF.

In order to create labels for vector objects perform the following actions:

1. Select object code in classifier.
2. Click the  button of the **Classifier** window toolbar. The **Set label** window opens.

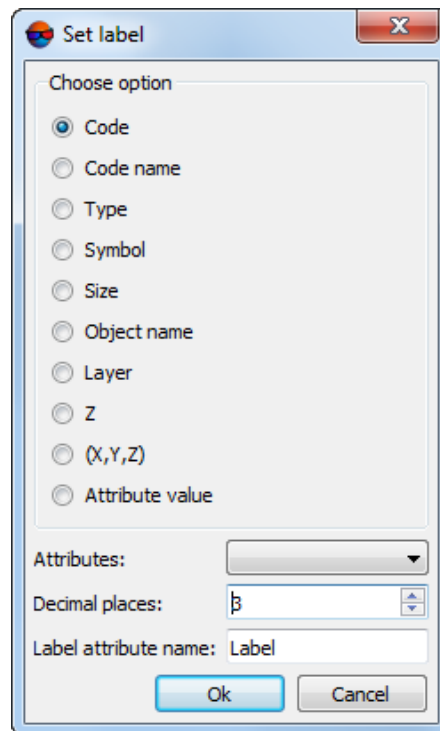



Fig. 89. Label creation

3. In the **Source data** section select one of the data sources to be used to move data to a label (see [Section 6](#)).
4. [optional] If the **Attribute value** was chosen, select code **attribute** in the list. These values show as label to an object in 2D-window or in the *AutoCAD program* (after export of selected code objects to DXF file).
5. [optional] Define **decimal places** to display in numerical labels. By default decimal number is three.
6. [optional] By default the **Label attribute name** is specified as the *Label*. To change the name input necessary name to appropriate field.
7. Click OK. Labels creates for all objects of selected layer. Labels display content of selected source. The labels are also displayed in the object's attributes list (see [Section 7](#)) with the *Label* name by default.

To set a label for all objects of selected layer, click the  button, after that the label is assigned to all objects in selected layer.

6.6. Association of vector objects with classifier.

Classifier's records are assigned to vector objects using two ways:

- during vector object creation select desired code in the classifier and start object vectorization, after that the code is assigned to the object automatically;
- assign code to existing object; to do that select vector object or object's group in 2D-window and desired code in classifier and click the  button (see [Section 8.2](#)).

6.7. Conversion of vector objects types

The system allows to convert polyline to polygon and vice versa while working with classifier.



When working in vector layer without classifier objects types conversion is performed automatically during closing/opening of a polyline (see [Section 11.4](#)).

In order to convert a polyline to polygon perform the following actions:

1. **Select** a polyline or a group of polylines.
2. Select in the classifier the C code type (polygon) and click the  button in the **Classifier** window. Polyline becomes closed and selected code is assigned to it.

In order to convert a polygon to polyline perform the following actions:

1. **Select** a polygon or a group of polygons.
2. Select in the classifier the L code type (polyline).
3. Click the  button of the **Classifier** window toolbar. The **Parameters of converting 'C' -> 'L'** window opens.

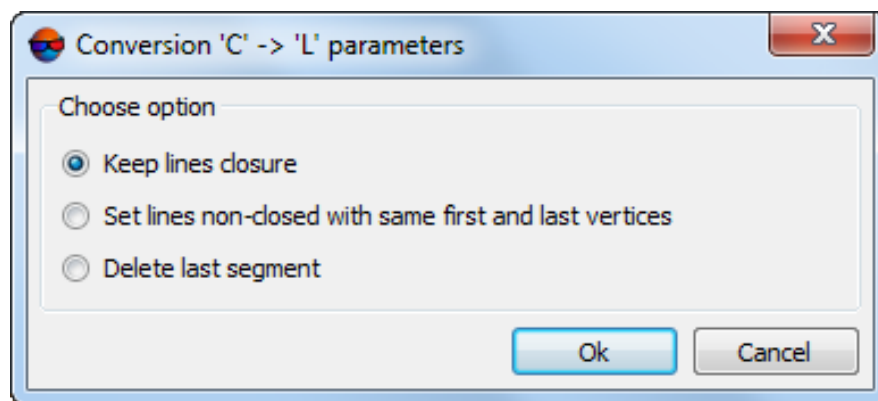

Fig. 90. Parameters of polygon to polyline conversion

4. Select one of the following ways of conversion:
 - **Keep lines closure** – a polygon is converted to closed polyline (non-areal object);

- **Set lines non-closed with the same first and last vertices** – a polygon is converted to opened polyline, which the first and the last vertices coincide;
 - **Delete last segment** – a polygon is converted to a polyline, and the segment between the first and the last vertices is deleted.
5. Click OK. Polygon converts to a polyline and selected code assigns to it (see the [Section 6.6](#)).

7. Vector objects attributes

To perform operations related to vector objects' attributes, **Vectors** › **Attributes** menu items are intended.





The functionality of the **Vectors** › **Attributes** menu is designed to work with the attributes of vector objects that were created in a layer without a classifier (as well as with additional attributes not referenced to the classifier code, created in a layer with a classifier; see below). Editing attributes created in a layer with a classifier and referenced to classifier codes is carried out in the **Classifier** window.

7.1. The “Attributes” menu

Table 8. Brief description of the “Attributes” menu”

Menu items	Function
Copy attributes from points to polygons	provides possibility to copy attributes of point objects and to assign them to polygonal objects
Merge point objects by attribute	to find all groups of points objects with equal values of defined attribute or replace any group of found points objects with one, placed in the center of all group
Select by attribute	provides possibility to search objects both by value and by attribute values list
Select by attribute value range	provides possibility to search objects by attribute values range
Select by attribute list	to search objects using attributes values list
Attribute value range...	to display minimal and maximal value of selected attribute
Color by attribute value...	provides possibility to display layer objects by different colors depending on the height, or by selected attribute of numerical type
Collate objects...	to perform search on a vector layer objects closest to the objects of another vector layer
Interpolate attribute value...	to to interpolate attribute values
Set labels...	provides possibility to create labels to vector objects both from attribute values and code table fields, and in the form of coordinates

Menu items	Function
Assign unique attribute value...	to assign a unique values to attributes of vector objects
Assign height from attribute	to set a height of vector objects from attribute
Save the objects height in the attribute	to save the objects height in the attribute
Arithmetic operations...	provides for arithmetic operations on the values of attributes of vector objects
Obligatory layer attributes	to assign required attributes to all layer's objects
 Autofilled layer attributes...	to fill layer's attributes automatically
 Automatic attributes filling	to automatically calculate area in specified measurement units
Label attributes	provides possibility to display labels of vector objects combined from multiple attributes with delimiters
Check layer semantic...	provides possibility to check layer's semantics – type, size and accuracy of selected attribute; existence of attribute value; uniqueness of attribute values set
 Calculate canopy of forest	provides possibility to calculate a value of <i>canopy</i> of trees cover (in range from 0 to 1) using measuring grid

7.2. Creation of vector objects attributes

7.2.1. Attributes creating and editing

The system provides possibility to create attributes both for vector objects codes (created in layer with classifier) and for vector objects created in a layer without classifier. Any additional parameter of the object, for example, object number, could be specified as attribute.

The **Vectors > Attributes** menu provides to work with attributes the system, as well as the **Attributes** tab in the **Classifier** window. Attributes table is displayed in the tab. It consists of attributes **Name**, **Type** and **Size** fields.

During work in a layer with classifier perform the following actions:

1. Select necessary code on the **Codes** tab of the **Classifier** window.
2. Select the **Attributes** tab and click the  button. The **Add attribute** window opens.

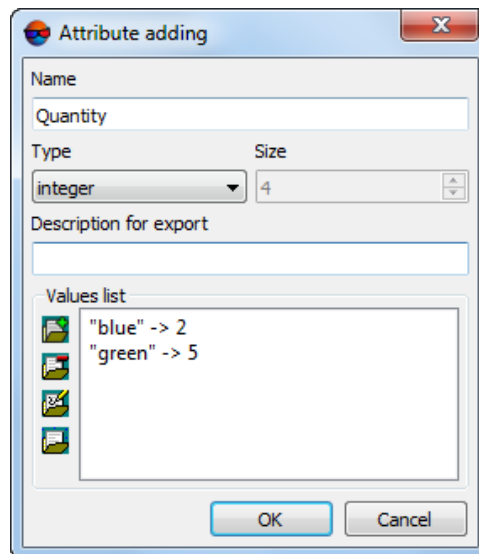





Fig. 91. The Add attribute window

3. Define the following parameters:

- **Name** of attribute;
- **Type** of attribute:
 - integer – attribute of integer type 4 bytes long;
 - float – attribute of real type 8 bytes long;
 - text – text attribute; text length is determined by its content, but not more than 8 bytes, otherwise – specifies fixed text length in bytes.
- **Size** (in bytes) – for numeric types of attributes is defined automatically, otherwise, is specified by user (for text attributes, for instance);
- **Description for export** – text field for correct [import/export](#) of attributes to MIF/MID format.

The **Values list** section allows to create list of preset values of *integer* attributes. The toolbar of section contains the following buttons:

-  – allows to add the attributes value;
-  – allows to remove selected attribute value from the list.
-  – allows to edit name and value of attribute value;
-  – allows to clear the attribute values list;



If there is a list of attribute values, it is possible to select values only from this list, otherwise, it is possible to select arbitrary values.

- Click OK. After that for selected code the attribute with specified parameters is created.

To edit attribute parameters is used the **Edit attribute** window. In order to open the window click the  button of the **Classifier** window.

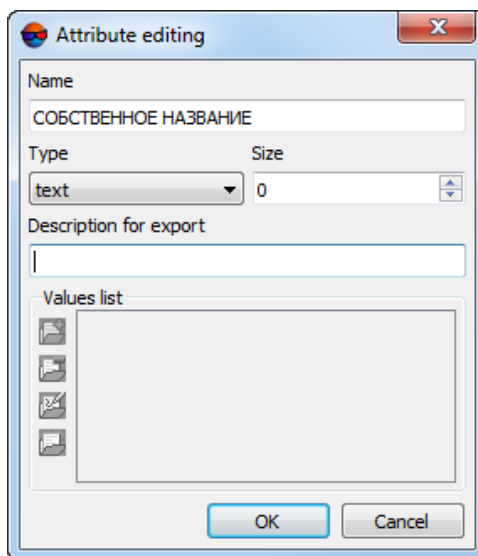







Fig. 92. Editing of object attribute

To delete active field of the attributes table click the  button on the **Attributes** tab of the **Classifier** window.

Toolbar on left part on **Attributes** tab allows to perform the following:

-  – move record to the top position;
-  – move record one position up;
-  – move record one position down;
-  – move record to the bottom position;
-  – rebuild the list of attributes in the reverse order.

In addition to creating the attributes attached to the classifier record, it is possible to create additional attributes, which are unique for the selected object. That means that all objects assigned to some classifier code, have common attributes specified in classifier, and it is possible to assign unique (“additional”) attributes to each of them.



In contrast to conventional attributes of objects, the system does not support the ability to export additional attributes to *.rsc files.

To input attribute values or to create additional attributes perform the following:

1. **Select** a vector object or vector objects group.



When multiple objects with attributes are selected, select only attributes with the same values in the table of **Objects attributes** window. Strings of attributes with different values highlights by red color.

2. Choose the **Window > Object attributes** or click the  button of the **Vectors** additional toolbar. The **Object attributes** window opens.

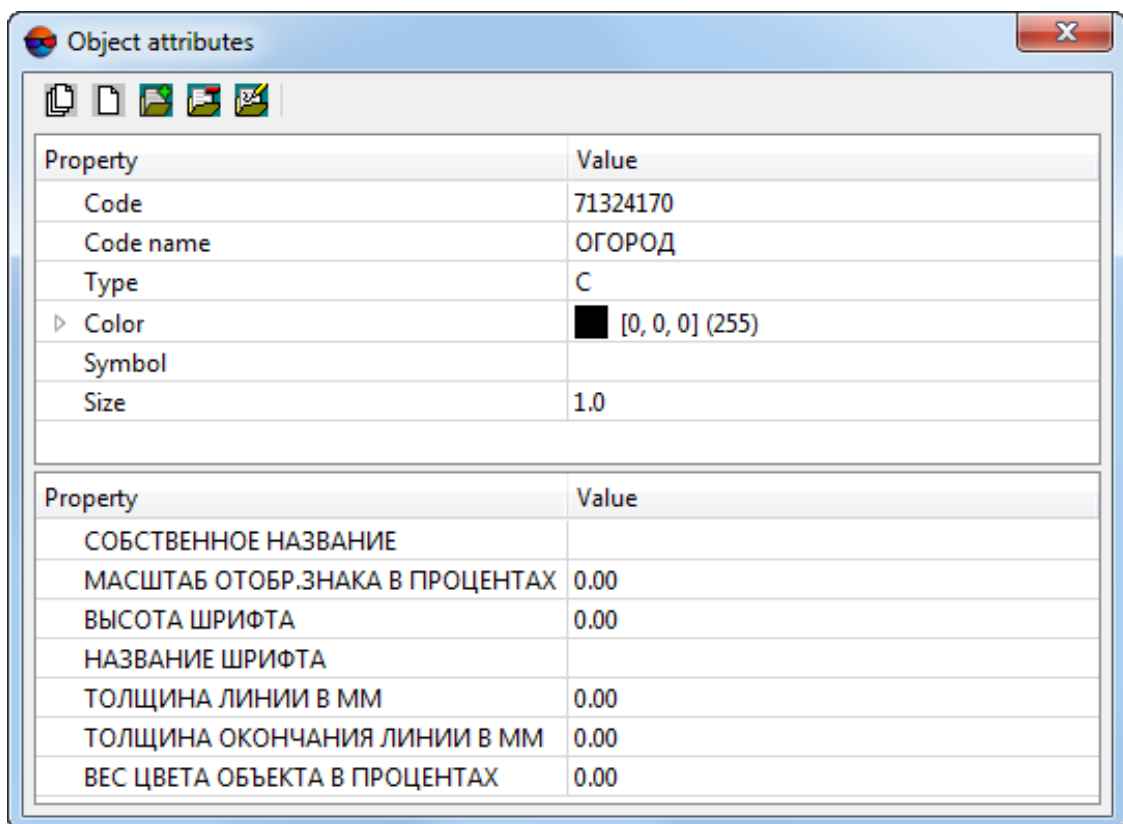







Fig. 93. Additional attributes (layer with Classifier)

The window that opens contains two tables. The upper table contains information on the classifier code (see [Section 6.1](#)). The lower table contains the list of object attributes. First of all, this table lists attributes referenced to the classifier code; below are unique (additional) object attributes (see above).



To see the list of classifier-code-referenced attributes (without additional attributes), open the **Attributes** tab in the **Classifier** window.

The following buttons are used to create and edit additional attributes:

-  – allows to delete all additional attributes of selected objects;
 -  – allows to delete additional attributes, common for selected objects;
 -  – allows to add a new additional attribute and its parameters;
 -  – allows to delete **additional** attribute selected in the table;
 -  – allows to edit properties of selected **additional** attribute;
3. [optional] To create additional attribute click the  button and set attribute name and type.
 4. Click on the table field in the **Value** column opposite to name of selected attribute. The field becomes editable then.
 5. Input attribute value.
 6. To complete editing and save changes press **Enter** or pass to the next cell.



To exit without saving changes press **Esc**.

The system provides possibility to copy attributes of point objects and to assign them to polygonal objects. To do this the **Vectors › Attributes › Copy attributes from points to polygons** menu item is used.

7.2.2. Creation attributes in layer without classifier

In addition to creating vector objects attributes attached to a specific code of the classifier, the system has the ability to create attributes of objects in the layer without classifier.

In order to add attributes, that are not attached to classifier code, perform the following actions:

1. Create or **load** vector **layer without classifier**.
2. **Select** a vector object.
3. Choose the **Window › Object attributes** or click the  button of the **Vectors** additional toolbar. The **Object attributes** window opens.

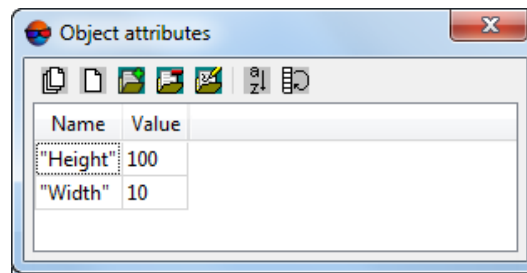









Fig. 94. Vector objects attributes (layer without Classifier)

The table fields have the same parameters described in [Section 7.2.1](#).

The following buttons are used to create and edit attributes:

-  – allows to delete all attributes of selected objects;
 -  – allows to delete common attributes of selected objects;
 -  – allows to add a new attribute and its parameters;
 -  – allows to delete selected attribute;
 -  – is used to edit selected attribute properties;
 -  – allows to sort attributes of selected objects;
 -  – allows to invert attributes of selected objects.
4. Click on the table field in the **Value** column opposite to name of selected attribute. The field becomes editable then.
 5. Input attribute value.
 6. To complete editing and save the input value press **Enter** or pass to the next attribute value cell.



To exit without saving changes press **Esc**.

7.2.3. Adding required attributes of a layer

The system allows to assign required attributes to all layer's objects.

In order to add required attributes to a layer objects, perform the following actions:

1. Make editable a layer for which to add required attributes.

2. Select **Vectors** › **Attributes** › **Obligatory layer attributes**. The **Required attributes** window opens.

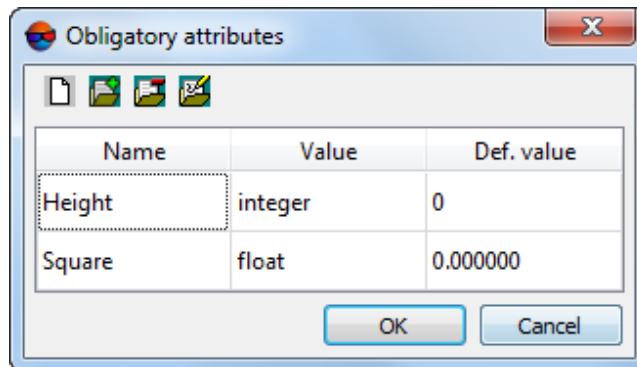





Fig. 95. The Required attributes window

The following buttons are used to create and edit additional attributes:

-  – allows to clear the obligatory attribute values list;
-  – allows to add a new attribute and its parameters;
-  – allows to delete attribute selected in the table;
-  – is used to edit selected attribute properties;

3. To add attribute click the  button. The **Edit attribute** window opens.

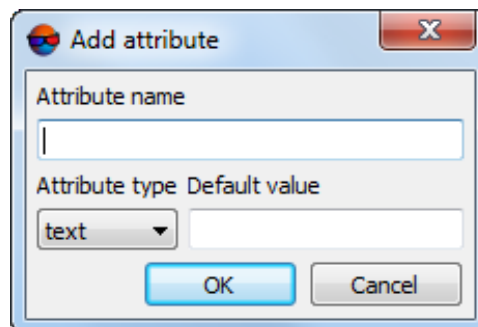

Fig. 96. Attribute parameters

4. Define the following parameters:
- **Attribute name;**
 - **Attribute type:**
 - *integer* – attribute of integer type;

- *float* – attribute of real type;
 - *text* – text attribute; text length is determined by its content, but not more than 8 bytes.
 - **Default value** – a value assigned automatically to all objects of selected layer as an attribute.
5. Click OK. Attributes from the list of the **Required attributes** window are assigned to all objects of selected layer.

7.2.4. Arithmetic operations on attribute values

The system provides for arithmetic operations on the values of attributes of vector objects created in the layer without a classifier (also on the values of extra attributes that are not referred to a classifier code, and created in the layer with a classifier).



Arithmetic operations are not available for attributes referred to a classifier code.

The results from arithmetic operations are saved as new attributes (or new values of the existing attributes). The system also allows for concatenation of attribute values.



Concatenation (latin concatenatio) is the operation of linking linear objects, usually strings. For example, the concatenation of the words “micro” and “wave” yields the word “microwave”.

To perform arithmetic operations on attribute values, perform the following:



All attributes are to be of the same type.

1. Create or load a vector layer that contains objects with proper attributes. Make this layer editable;
2. [optional] To perform arithmetic operations for the selected objects only, **select** the desired vector object (or a group of objects);
3. Choose **Vectors** › **Attributes** › **Arithmetic operations**. The **Arithmetic operations** window opens:

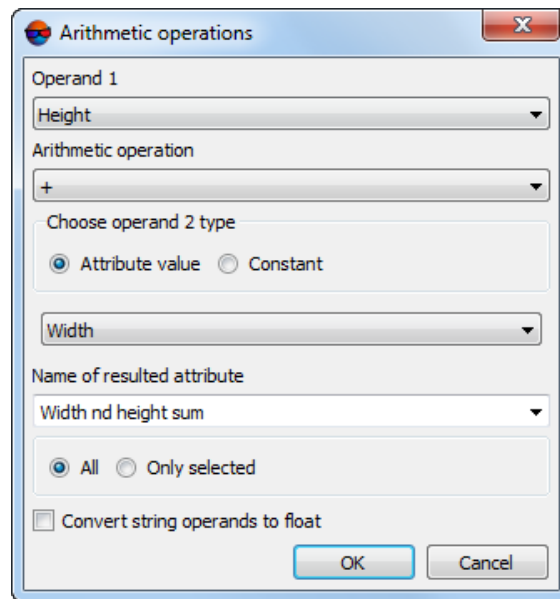

Fig. 97. The Arithmetic operations window



If loaded vector layers containing objects with proper attributes are absent, an appropriate info message is issued.

4. In the **Operand 1** drop-down list, select the name of the attribute on the values of which it is needed to perform an arithmetic operation;
5. In the drop-down list, select the **arithmetic operation** to be performed (addition, subtraction, multiplication, or division);
6. Select the **Operand 2** option to be used and set its values:
 - [optional] **Attribute value** – select the name of an attribute the value of which is to be used as the **operand 2**;
 - [optional] **Constant value** – is to be set in the appropriate field.
7. Enter the **name of resulted attribute** in the appropriate input field (in case if the result is to be recorded as new attribute values) or select the name of the existing attribute from the drop-down list (to overwrite the calculation results instead of its current values);



One of operands can be used as an attribute for recording the result.

8. Select objects in the editable layer subjected to an arithmetic operation, **all** or **only selected**;
9. Leave the **Convert string operands to float** checkbox set;

10. Click OK.

After the operation is complete, an appropriate message on the number of processed and skipped attributes is issued.

If the value of the first and/or of the second operand is not a number, this vector object will be excluded from the processing and its attributes will be marked as skipped.

It must be considered, that the drop-down lists intended for selecting the attribute name (used to record the result or as the operand 1 or 2) display all the attributes not referred to classifier codes assigned to vector objects of the editable layer. These may include attributes assigned to only some (but not all) objects.

Accordingly, in order for an arithmetic operation on the attributes of a particular vector object to be performed, both attributes used as the first and second operands must be assigned to this object.

Similarly, if an already existing attribute is selected for recording the results, its values will be overwritten for the objects to which it was previously assigned, while the specified attribute will be assigned to other involved objects as a result of the operation.

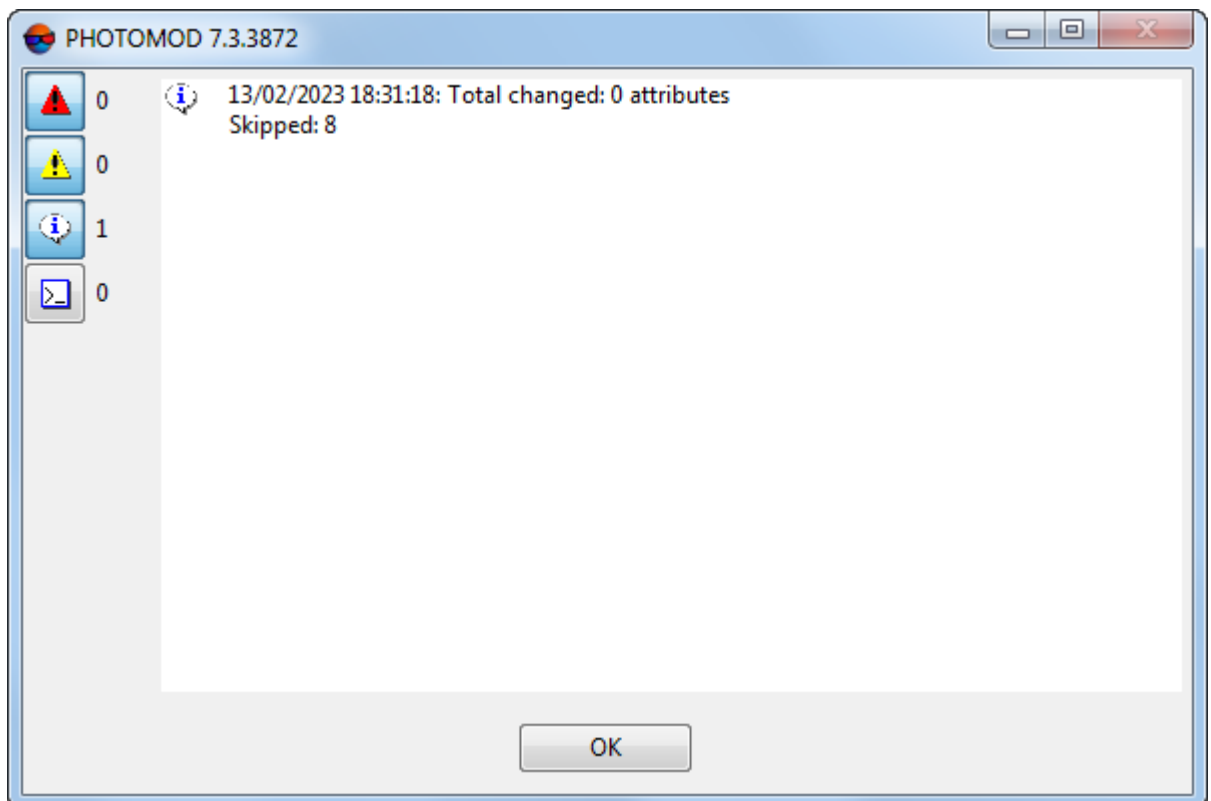

Fig. 98. An info message

To perform concatenation (merging together) of attribute values, perform the following:



All attributes involved (operand 1 and operand 2) are to be of the same *text type*.

1. Create or load a vector layer that contains objects with proper attributes. Make this layer editable;
2. [optional] To perform arithmetic operations for the selected objects only, **select** the desired vector object (or a group of objects);
3. Выберите **Vectors** › **Attributes** › **Arithmetic operations**. The **Arithmetic operations** window opens:

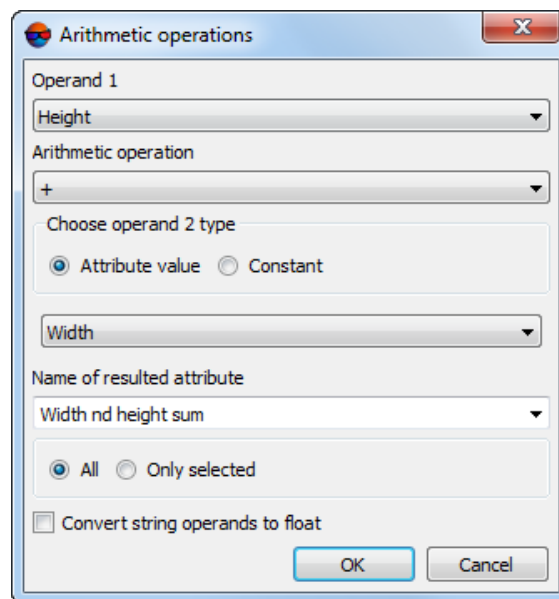

Fig. 99. The Arithmetic operations window



If loaded vector layers containing objects with proper attributes are absent, an appropriate info message is issued.

4. Select the name of the desired attribute in the **Operand 1** drop-down list;
5. Select the addition operation in the **arithmetic operation** drop-down list;
6. Select **Value from attribute** as **Operand 2** option and in the appropriate drop-down list select the name of the attribute the values of which is to be used as the **operand 2**;
7. Enter the **name of resulted attribute** in the appropriate input field (in case if the result is to be recorded as new attribute values) or select the name of the existing

attribute from the drop-down list (to overwrite the calculation results instead of its current values);



One of operands can be used as an attribute for recording the result.

8. Select objects in the editable layer subjected to an arithmetic operation, **all** or **only selected**;
9. Clear the **Convert string operands to float** checkbox;
10. Click OK.

After the operation is complete, an appropriate info message on the number of processed and skipped attributes is issued. The merged values of the first and second operands will be written as the values of the attribute selected for recording the results.

7.3. Vector objects labels

7.3.1. Labels creation

The system provides possibility to create labels to vector objects both from attribute values and code table fields, and in the form of coordinates.

To create labels to vector objects perform the following actions:

1. Select **Vectors** > **Attributes** > **Set labels**. The **Set label** window opens.

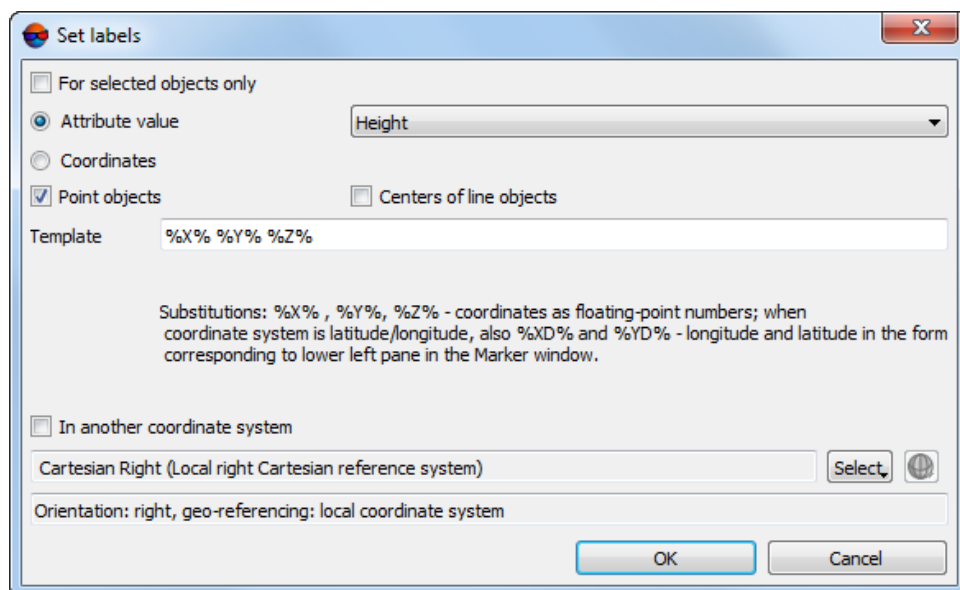

Fig. 100. Labels parameters

2. [optional] To set labels to selected objects, set the **For selected objects only** checkbox on.
3. Select one of options of labels creation:

- **Attribute value** – labels create from values of selected attribute;
- **Coordinates** – object coordinates display as labels (depending on object type);
 - **Point object** – display coordinates of points and polygon/polyline vertices;
 - **Centers of line object** – display coordinate of line objects centers;

Coordinates should be created using the **template** %X% %Y% %Z%.



Set on both objects to display labels for all object types.



The system allows to create labels in the coordinate system different from project coordinate system. To do this set the **In another coordinate system** checkbox on and [select coordinate system](#) to be displayed.

4. Click OK. After that labels to selected objects are displayed in 2D-window.



There are hotkeys to hide labels: in active layer – **Ctrl+H**, in all layers – **Ctrl+Shift+H**. Also the **Edit › Active layer › Show/Hide labels in active layer** menu item allows to hide labels.



The value specified in the **Import/export etc.** field is used to define number of decimal places for attributes labels (see the “Setup of modules start” chapter of the “[General system's parameters](#)” User Manual).



The value specified in the **Import/export etc.** field is used to define number of decimal places for coordinates labels (see the “Setup of modules start” chapter of the “[General system's parameters](#)” User Manual).

7.3.2. Labels attributes

The system provides possibility to display labels of vector objects combined from multiple attributes with delimiters.

In order to show combined labels perform the following actions:

1. Select **Vectors › Attributes › Label attributes**. The **Layer label attributes** window opens.

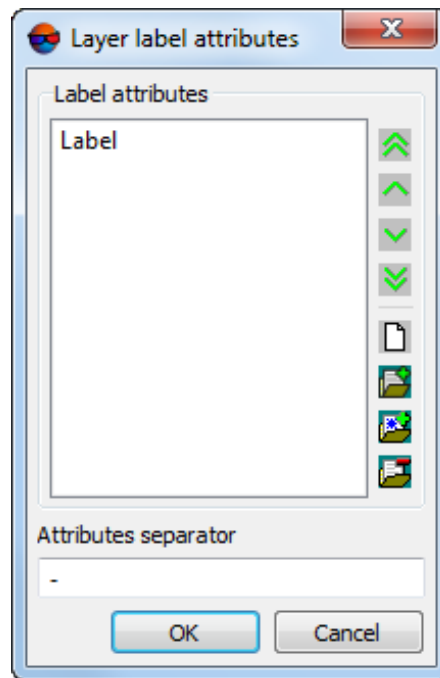









Fig. 101. Layer labels

The window **Layer label attributes** contains the toolbar for the following operations:

-  – moving attribute to the top position;
-  – moving attribute one position up;
-  – moving attribute one position down;
-  – moving attribute to the bottom position;
-  – allows to clear the attributes list;
-  – allows to add new attribute;
-  – allows to add attribute from list of existing layer attributes;
-  – allows to remove selected attribute.

2. In the **Label attributes** section the list of available attributes with labels is displayed.
3. In the **Attributes separator** section specify a symbol to be used as a separator of attributes.



The system supports special symbols of *XML* markup language that are used as separators.



Line spacing is set on the **Labels** tab of the **Settings** window (see the “[General system's parameters](#)” User Manual).

- Click OK. As a result, for vector objects vertices having attributes the labels in the form of attribute values with specified delimiter are displayed in 2D-window.



During [automatic polygon attributes assigning](#) or at manual attributes change labels attributes are updated automatically.

7.4. Attributes assigning

7.4.1. Assigning of unique attribute value

Unique values could be assigned to attributes of vector objects. This simplifies combining objects into groups by attribute values and automate the assignment of attribute values to vector objects. This function is used for further work in *3D-Mod program*.

To assign unique attribute value to objects, perform the following actions:

- Select a vector object or multiple objects in 2D-window.
- Select **Vectors** > **Attributes** > **Assign unique attribute value**. The **Assign unique attribute value** window opens.

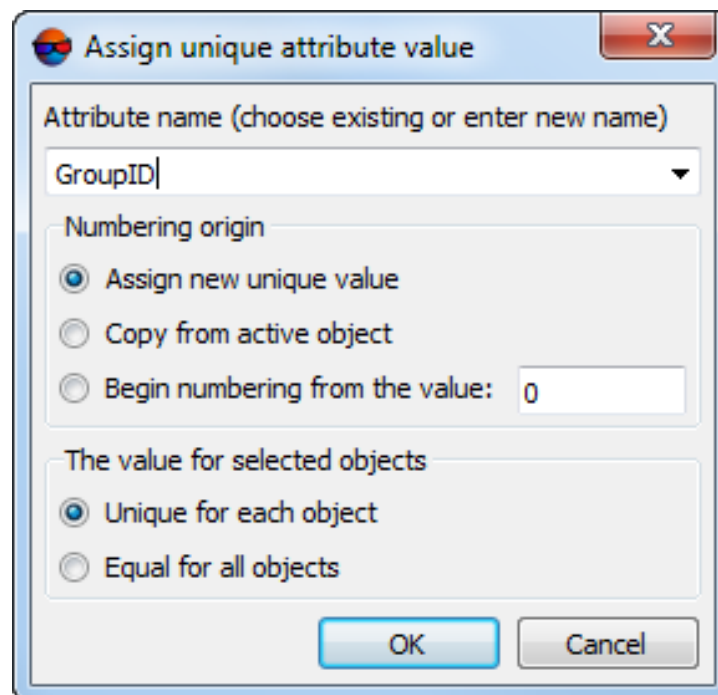

Fig. 102. Parameters of unique attribute values

- Select attribute in the **Attribute name** field to input unique value or specify a new attribute name.



When you define a new attribute name the system creates an additional attribute of integer type for the selected objects.

4. Select one of the following ways of unique value assigning:
 - **Assign new unique value** – allows to specify new unique value of active object attribute;
 - **Copy from active attribute** – allows to copy a value of selected object attribute;
 - **Begin numbering from the value** – allows to start numbering from arbitrary number specified in this field.
5. Select a way to specify **the value of selected objects**:
 - **unique for each object**;
 - **equal for all objects**.
6. Click OK. Unique attribute value is assigned to selected vector objects.

7.4.2. Save the objects height in the attribute

The system allows to save the objects height in the attribute. Height calculates as difference between the value of the DEM cell and height of the object vertices.



This function may be used to save roof heights over the ground level as attributes.

In order to save the objects height in the attribute perform the following actions:

1. Load a vector layer and a DEM in the project.



For correct work of the function make sure, that only one layer with vector object and only one DEM is opened in the current project.

2. Select **Vectors > Attributes > Save objects height above DEM to attribute**. The **Layers selection** window opens.

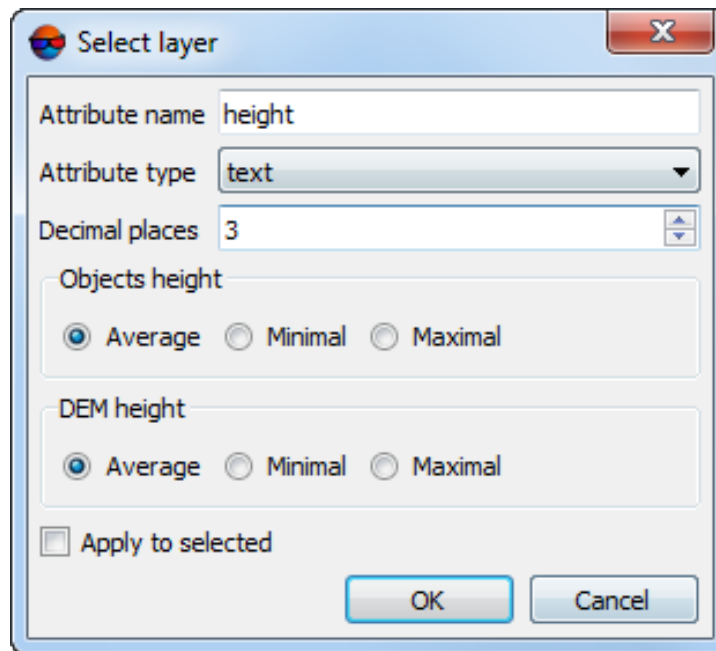

Fig. 103. Parameters of saving the objects height in the attribute

3. Define the following parameters in the window:
 - **Attribute name** – "height" by default;
 - **Attribute type** – text, integer or float;
 - **Decimal places** – allows to specify the number of decimal places (from 0 to 24);
 - **Objects height** – allows to use **average**, **minimal** or **maximal** height of vector object vertices to define difference with DEM;
 - **DEM height** – allows to use **average**, **minimal** or **maximal** value of DEM cells around vector object to define difference with the object.
4. [optional] To assign objects height only to attribute of selected objects, set the **Apply to selected** checkbox on.
5. Click OK. As a result, height difference is assigned to all or selected objects of vector layer as attribute.

7.4.3. Assigning height from attribute

The system allows to set a height of vector objects from attribute.



Given function works correctly if an attribute regardless of its type constitutes a number. Otherwise specified value of vector object height will be equal zero.

To assign a height of vector objects from attribute perform the following actions:

1. [optional] Select vector objects, height of which is necessary to set;
2. Select **Vectors** › **Attributes** › **Assign height from attribute**. **Assign height from attribute** window is opened.

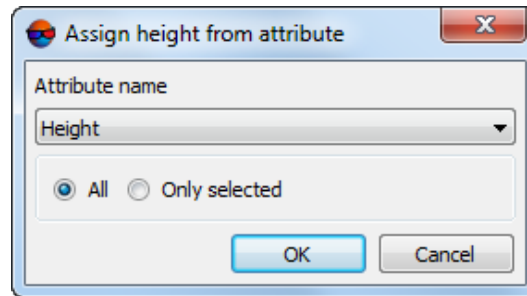

Fig. 104. Settings of assigning object heights to attributes

3. Select from the list an attribute value of which will be set as a height;
4. [optional] Set parameter **Selected** to assign height from attribute to selected objects only;
5. Click OK. As a result the value of attribute selected is assigned as a height to the all or to selected objects of vector layer which have a given attribute.

7.4.4. Automatic filling layer's attributes

The system allows to fill layer's attributes automatically.

Perform the following actions for creating autofilled attributes:

1. Make editable a layer for which to add autofilled attributes.
2. Create **attribute** with *float* type.
3. [optional] To display a value of autofilled attribute in 2D-window specify **labels attributes** for created attribute.



Labels attributes refresh automatically.

4. Choose **Vectors** › **Attributes** › **Autofilled layer attributes** or click the  button of the **Vectors** additional toolbar. The **Autofilled attributes** window opens.

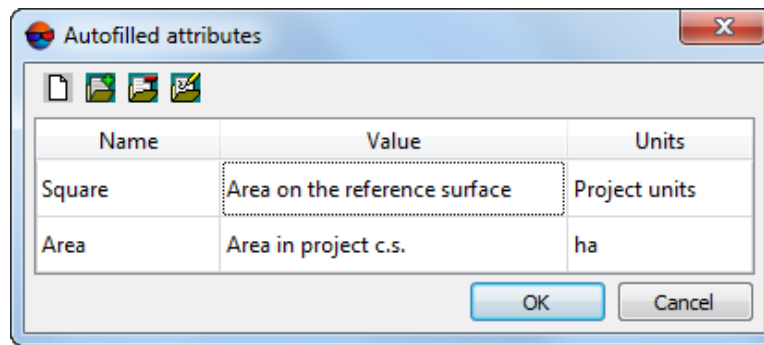





Fig. 105. The Autofilled attributes window

The window **Autofilled attributes** contains the toolbar with buttons used to perform the following operations:

-  – is used to clear the attributes list;
-  – is used to add new obligatory attribute;
-  – is used to remove selected attribute.
-  – is used to edit parameters of selected attribute.

5. To add click the  button. The **Edit attribute** window opens.

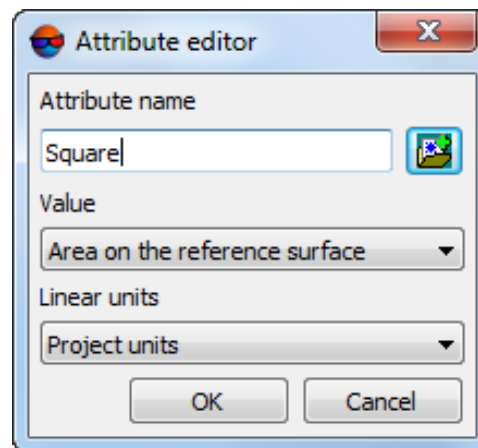

Fig. 106. Attribute editing

6. Click the  button to select attribute from attributes list.

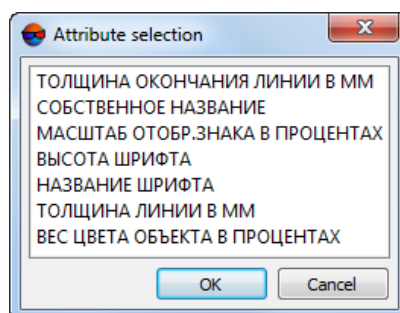

Fig. 107. Selection from list of mandatory attributes





A name of autofilled attribute should be the same as a name of attribute.

- In the **Value** list select a value to be used for autofilling: **Area in project CS** or **Area on the reference surface**.



A value of the area *on the reference surface* is calculated only when using coordinate system matched with WGS-84.

- Select one of the following area measurement units: **project units, sq.m, ha, sq.km**.
- Click OK.
- Choose **Vectors > Attributes > Automatic attributes filling** or click the  button to automatically calculate area in specified measurement units. The value is displayed in the **Object attributes** window and/or as attributes labels (see [Section 7.3.2](#)).

The polygon square, created or edited *after* setting autofilling attributes, also could be displayed. To do this choose **Vectors > Attributes > Automatic attributes filling** or click the  button. Attribute value refresh for all polygons in active layer.



If not mandatory attributes are used as autofilling, they are not assigned to a new objects. To display square of a “new” polygons, it is required to create *float* attribute with name, equal to name of autofilling attribute and click the  button.

7.4.5. Objects collation

Objects collation operation is used to search on a vector layer objects closest to the objects of another vector layer.



This operation is a specialized and used to automate search of differences between two versions of the file with exterior orientation parameters, if there is a possibility that one of them contains wrongly compared names and images and projection center coordinates.

Perform the following actions to do collation:

1. Select **Vectors** > **Attributes** > **Collate objects**. The **Collate objects** window opens.

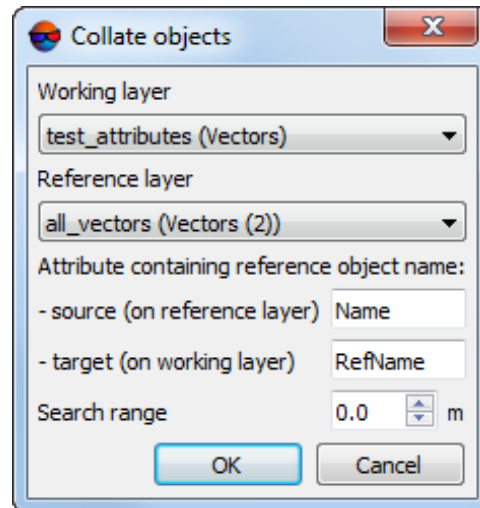

Fig. 108. Parameters of objects collation

2. Select **Working layer**, where it is necessary to perform objects collation.
3. Select **Reference layer**, where to search objects closest to working layer objects.
4. [optional] To perform search for objects with specified attribute name, input the **Attribute containing reference object name** to the **source (on reference layer)** field.
5. [optional] To record the values of found objects attributes of the reference layer to attributes of the working layer objects, input the **Attribute containing reference object name** to the **target (on working layer)** field.
6. Specify the **Search range** value in meters, within which the search is performed.
7. Click OK. After that each object of the working layer contains attribute with the name of closest object of the reference layer.



The working layer is available for export to format which supports tabular format of attributes recording (for example, [to DBF](#)) to create match list of one layer objects to another for further analysis.

7.4.6. Using attributes when building 3D-objects







The *3D-Mod* software supports import of vector objects from ASCII-A-files as initial data for automatic creation of 3D-objects (see the “[Three-dimensional modeling](#)” User Manual). When building 3D-objects in the 3D-Mod software, there is also a capability

to use values of the type attribute of imported vector objects that determine the way of object data using when building.







The system allows for creating the type attribute and assigning values to it directly during the vectorization process as part of data preparation for further work in the *3D-Mod*.

To assign type attribute values, use 3D-Mod toolbar (**Window** > **Toolbars** > **3D-Mod**).





Table 9. The “3D-Mod” toolbar

Button	Purpose
	enables the value input mode for the type attribute
	to create a type attribute and assign the none value to it for all vector objects to be created
	to create a type attribute and assign the object value to it for all vector objects to be created
	to create a type attribute and assign the break value to it for all vector objects to be created
	to create a type attribute and assign the library value to it for all vector objects to be created
	to create a type attribute and set the chosen value to it (None , Obj , Brk or Lib), for all selected already existing objects

To assign type attribute values to vector objects to be created, perform the following:

1. Open the **3D-Mod** toolbar (**Window** > **Toolbars** > **3D-Mod**);
2. To enable the type attribute value input mode, click the  button on the **3D-Mod** toolbar;
3. Choose one of the type attribute values by clicking the , ,  or  buttons;
4. Create one or more vector objects;
5. To disable the type attribute value input mode, click the  button on the **3D-Mod** toolbar.





The user can change type attribute values before creation of the next vector object by clicking the , ,  or  buttons, if appropriate.



To check the attribute value, select a vector object and choose **Window** > **Object attributes** or click the  button on the **Vectors** additional toolbar. The **Object attributes** window opens.

To assign type attribute values to already existing vector objects, perform the following:

1. Open the **3D-Mod** toolbar (**Window** › **Toolbars** › **3D-Mod**);
2. To enable the type attribute value input mode, click the  button on the **3D-Mod** toolbar;
3. Select one or more vector objects;
4. Choose one of the type attribute values by clicking the **None**, **Obj**, **Brk** or **Lib** buttons;
5. Click the **Set** button;
6. To disable the type attribute value input mode, click the  button on the **3D-Mod** toolbar.



To check the attribute value, select a vector object and choose **Window** › **Object attributes** or click the  button on the **Vectors** additional toolbar. The **Object attributes** window opens.

7.5. Operations with objects using attributes

7.5.1. Merging point objects by attribute

Operation of merging point objects by attribute allows:

- to find all groups of points objects with equal values of defined attribute;
- replace any group of found points objects with one, placed in the center of all group.



This operation is used, for example, to perform generalization of map, where some physical objects are displayed by point objects groups, and in the attributes of each group objects is registered a name of a real object, to which these point objects relate to.



If it is necessary to merge closed polygons groups using the same principle, use the **Convert polygons to points** function in advance.

For transformation perform the following actions:

1. Choose **Vectors** › **Attributes** › **Merge point objects by attribute**. The **Group objects by attribute** window opens.

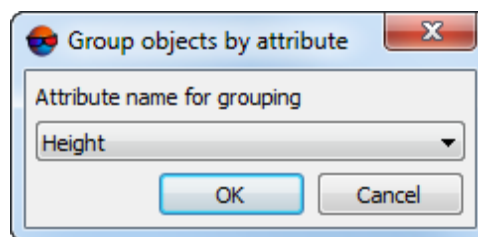

Fig. 109. Attribute name selection

2. Selection attribute name from the list, which values are used for the merging.
3. Click OK. The system performs search of all point objects with specified attribute. Objects found are grouped by attribute value, then in each group all objects are removed, except for the one randomly selected. The remaining object is moved to mass center of the original group.



If in the active vector layer there is no point object that has an attribute with the specified name, the system displays an error message.

7.5.2. Object search using attribute value

The system provides possibility to search objects both by value and by attribute values list.

To search objects using attributes values perform the following actions:

1. Select **Vectors** > **Attributes** > **Select by attribute**. The **Find by attribute** window opens.

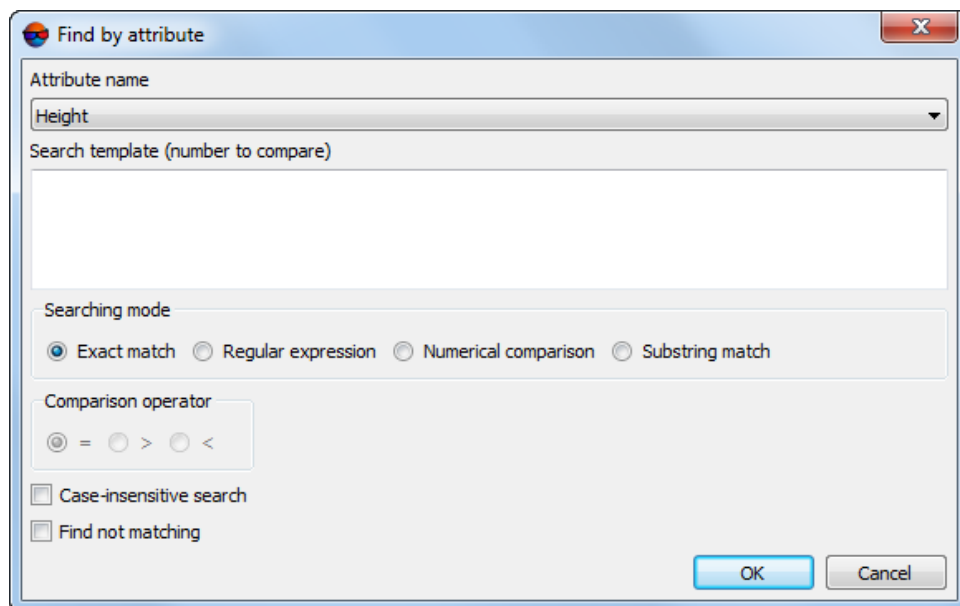

Fig. 110. Search by attribute

2. In the **Attribute name** field select attribute that values will be used to perform the search.
3. In the **Search template** field input text line or number, that will be used to perform the search. The value of this field is interpreted by the system depending on the search mode.

4. Select one the search modes:
 - **Substring match** – the system searches for objects whose attribute value contains the string template;
 - **Exact match** – the system searches for objects whose attribute value is exactly the same as search template;
 - **Regular expression** – the system searches for objects whose attribute value matches the regular expression specified in the **Search template** field;
 - **Numerical comparison** – the system searches for objects, for which the numerical value of the search string is compared with the attribute value using one of the comparison operators=, >, <.
5. [optional] To search for objects using case insensitive search set the **Case insensitive search** checkbox on.
6. [optional] To search for objects that do not have the specified attribute or which value does not satisfy the search condition, set the **Find not matching** checkbox on.
7. Click OK. Found objects are highlighted in 2D-window.



Found objects highlight considering active [group selection mode](#).

To search objects using attributes values perform the following actions:

1. Select **Vectors** > **Attributes** > **Select by attribute list**. The **Search by attribute values list** window opens.

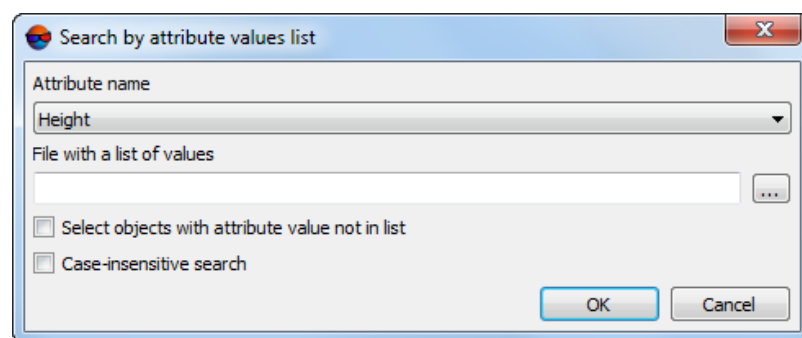



Fig. 111. Search by attributes list

2. In the **Attribute name** field select attribute that values will be used to perform the search.

3. In the **File with a list of values** field click the  button and select a *.txt file containing a list of values for search (each value on a new line).
4. [optional] Set the **Select objects with attribute value not in list** checkbox on, to found those objects that have no attribute values in the selected list.
5. [optional] To perform search using case insensitive search set the **Case insensitive search** checkbox on.
6. Click OK. Found objects are highlighted in 2D-window.



Found objects highlight considering active [group selection mode](#).

7.5.3. Select by attribute value range

The system provides possibility to search objects by attribute values range.

Perform the following actions to do this:

1. Select **Vectors** › **Attributes** › **Select by attribute value range**. The **Search by attribute values range** window opens.

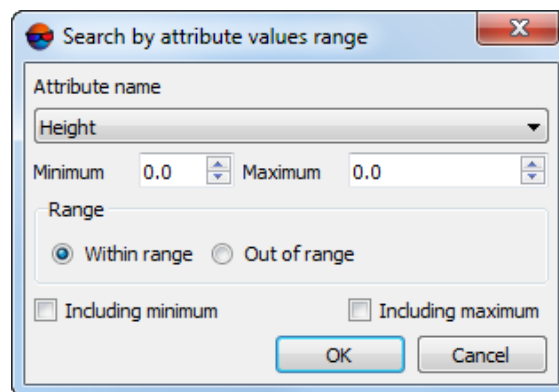

Fig. 112. Search by attribute

2. In the **Attribute name** field select attribute that values will be used to perform the search.
3. In the **Minimum** and **Maximum** fields specify value range for search.
4. Choose the task for processing in the **Range** section:
 - **Within range** – to find attributes with values within specified range;
 - **Out of range** – to find attributes with values out of specified range.

5. [optional] Set the **Including minimum/maximum** checkboxes on to consider min/max values during search.
6. Click OK. Information message about loaded vectors is displayed. Found objects are highlighted in 2D-window.



Found objects highlight considering active [group selection mode](#).

7.5.4. Custom object paint

The system provides possibility to display layer objects by different colors depending on the height, or by selected attribute of numerical type.

In order to change objects coloring on active layer, perform the following actions:

1. Select **Vectors › Attributes › Color by attribute value**. The **Custom objects paint** window opens.

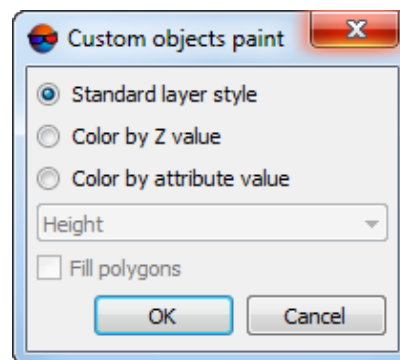

Fig. 113. Parameters of objects paint using attributes

2. Select one of the ways to change the color of layer's objects:
 - **Standard layer style** – vector objects color set in the layer properties;
 - **Color by Z value** – color of vector objects changes by altitude scale depending on object Z-coordinate value;
 - **Color by attribute value** – color of vector objects changes by values of selected attribute.



It is possible to use text attribute if all its values could be converted into number;

3. [optional] To fill the layer's polygons in accordance with values of selected attribute, set the **Fill polygons** checkbox on.
4. Click OK. As a result, the coloring of objects is changed depending on selected options.



Objects that have no selected attribute are displayed in gray.

7.6. Attribute value range

The system allows to display minimal and maximal value of selected attribute.

Perform the following actions to do this:

1. Make vector layer active.
2. Select **Vectors** › **Attributes** › **Attribute value range**.

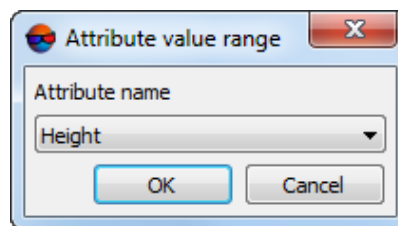

Fig. 114. Attributes value range

3. Choose attribute name to find its maximum and minimum value.
4. Click OK. Information window with the following information about the attribute displays. If the selected attribute has text type or has no values, the system displays an appropriate error message.

7.7. Attributes value interpolation

The system provides possibility to interpolate attribute values. It is used to define images exterior orientation parameters, acquired by unmanned aerial vehicles and having only the data about the time of image acquisition.

To interpolate attributes values, perform the following actions:

1. **Load** a vector layer;



For vector objects, it is necessary to have at least one layer with at least two different attributes.

2. Select **Vectors › Attributes › Interpolate attribute value**:

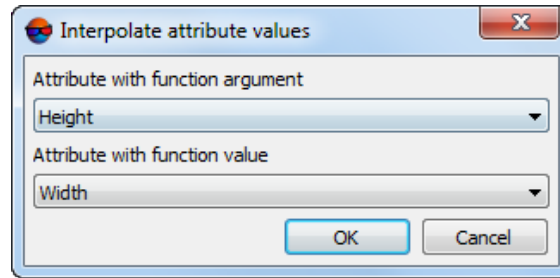

Fig. 115. The Interpolate attribute values window







3. In the **Attribute with function argument** field select attribute name of numeric type that will be used for interpolation as a function argument.
4. In the **Attribute with function value** field select attribute name of numeric type that will be used for interpolation as a function value.
5. Click OK. As a result, an interpolated value of attribute, specified as a function value is assigned to objects that contain only argument attribute.

7.8. Layer's semantics check

The system provides possibility to check layer's semantics. The following parameters is checking:

- type, size and accuracy of selected attribute;
- existence of attribute value;
- uniqueness of attribute values set.

The **Check semantics** window is used to configure parameters of the operation, and it contains the following buttons:

-  – allows to clear the attributes list;
-  – allows to add a new attribute and specify semantics check parameters for it;
-  – is used to add attribute existing in the list of layer attributes;
-  – allows to remove selected attribute from the list;
-  – allows to edit selected attribute properties;
-  – allows to load the attribute template file;

-  – allows to save the attribute list to file for further using as a template.

To perform semantic check, perform the following actions:

1. Select **Vectors > Attributes > Check layer semantic**. The **Check semantics** window opens.

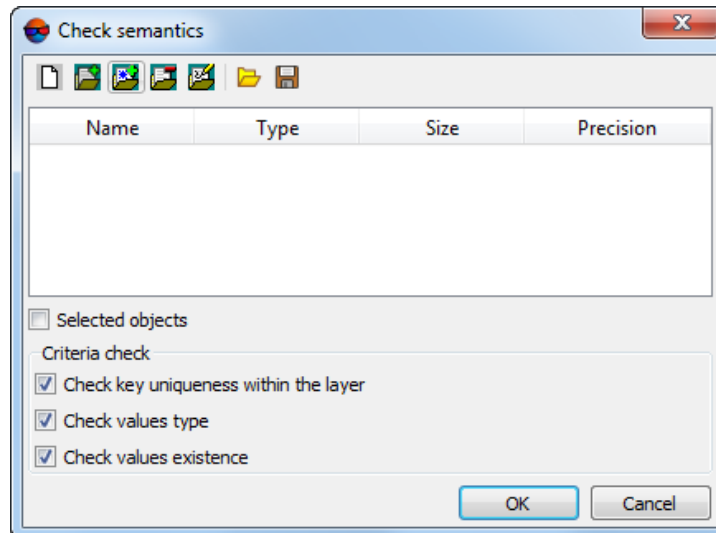



Fig. 116. The Check semantics window opens.

2. Prepare attribute list with one of the following way:

- to select existing attribute from the list, click the  button. The **Attributes selection** window opens. Select single or multiple attributes by mouse click and click OK.

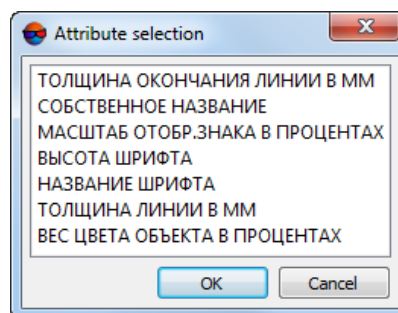

Fig. 117. The window used to select attributes from existing ones

- to add a new attribute click the  button. The **Edit attribute** window opens.

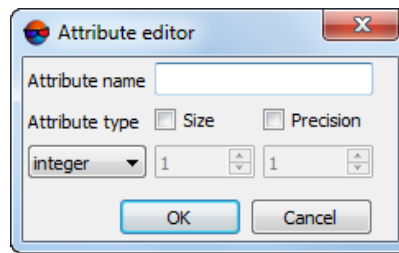



Fig. 118. The Edit attribute window

3. [optional] Define attribute parameters. When create a new attribute, the **Edit attribute** window opens automatically. To open window for attribute from the list, double-click on attribute name or click the  button.

Define the following parameters:

- **Attribute name** – arbitrary name;
 - **Type** – attribute type; the system supports the following types:
 - *integer* – attribute of integer type 4 bytes long;
 - *float* – attribute of real type 8 bytes long;
 - *text* – text attribute.
 - **Size** (in bytes) – [for number types of attributes] to check the attributes size;
 - **Precision** – [for number types of attributes] decimal places.
4. [optional] To check semantics of selected objects only, set the **Selected objects** checkbox on, otherwise, the check operation will be performed for all objects.
 5. The **Criteria check** section is used to select single or multiple criteria to check layer semantics:



If the specified attribute is absent for object, the system displays error message.

- **Check key uniqueness within the layer** – the system creates a key (a set of consecutive parameters) for values of selected attributes and checks uniqueness of the key value for each object of the layer.
- **Check values type** – for specified attributes of each object of the layer the system checks for the compliance of the attribute value to type, size and accuracy;
- **Check values existence** – for specified attributes of each object of the layer the system checks for the attribute values other than the default.



As default values for attributes of “text” type is provided an empty string, for attributes of “float” and “integer” type – “0” value. If the attribute is **mandatory**, the system also performs check its default value.

- Click OK. The system starts operation of layer semantics check. If there are some discrepancies the system shows warning and the **Errors in attributes** window opens. It contains the list of errors found:

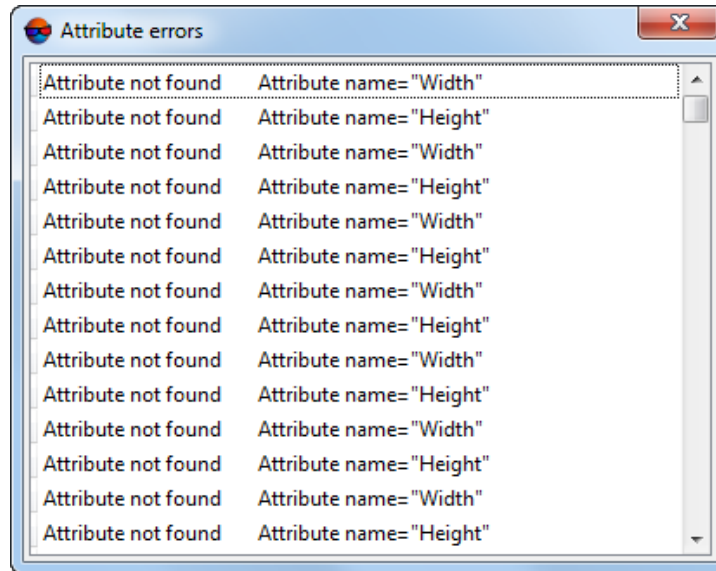

Fig. 119. The Errors in attributes window



During check of the key uniqueness the error message informs about number of objects with non-unique attributes.

- Select a line with error in the list by mouse click. The appropriate object (or objects) select in the layer, marker is moved on a stereopair with the object and is placed to the object center. Error correction is performed manually in the **Objects attributes** window.

7.9. Calculation canopy of forest

The system provides possibility to calculate a value of *canopy* of trees cover (in range from 0 to 1) using measuring grid.

To perform canopy calculation perform the following actions:

- Open a stereopair with the investigated woodland.
- Select **Grid > Create**.
- Select **Grid > Properties** and specify the grid step considering image resolution.

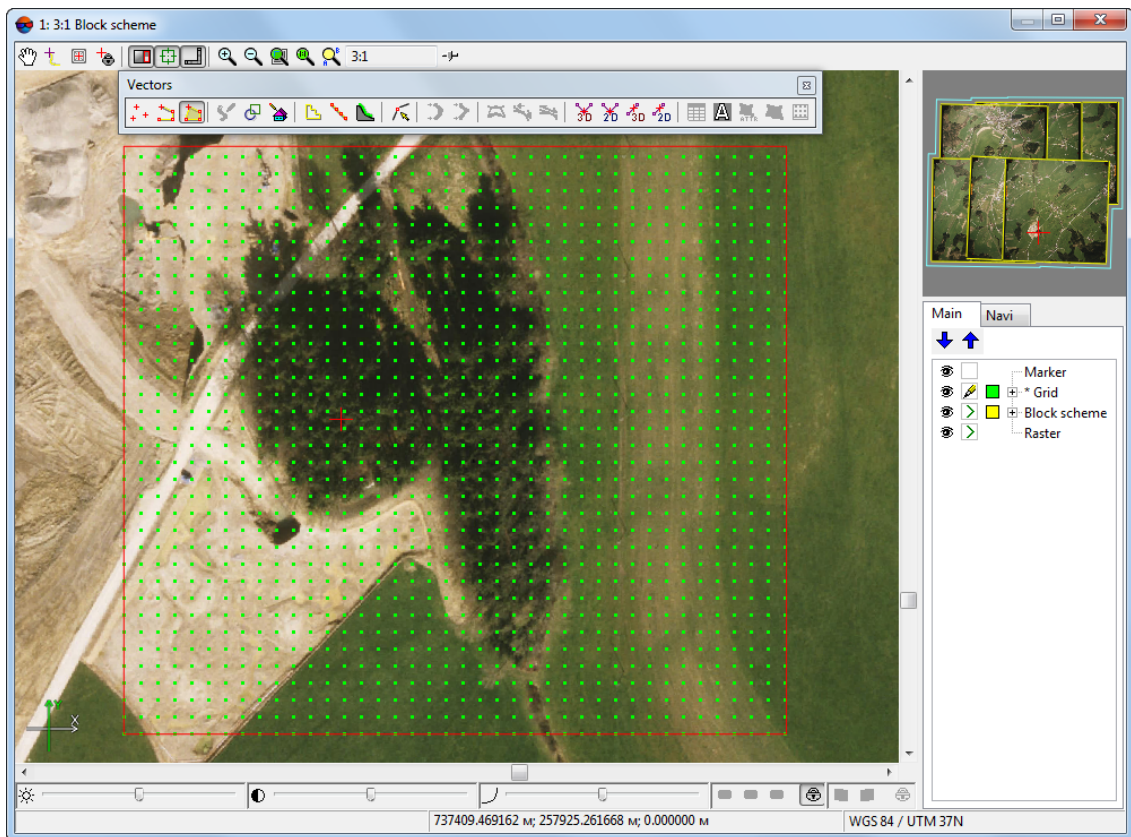

Fig. 120. Measuring grid creation

4. Press and hold the **Shift** key to draw rectangular grid for woodland area.



The grid should extend beyond the woodland area.

5. Choose **Vectors** > **Create layer** to create a layer without classifier.
6. Create a polygon in such a way that its boundary coincides with woodland boundaries.
7. Select **Grid** > **Create boundaries from vectors**. After that grid boundary coincides with created polygon.

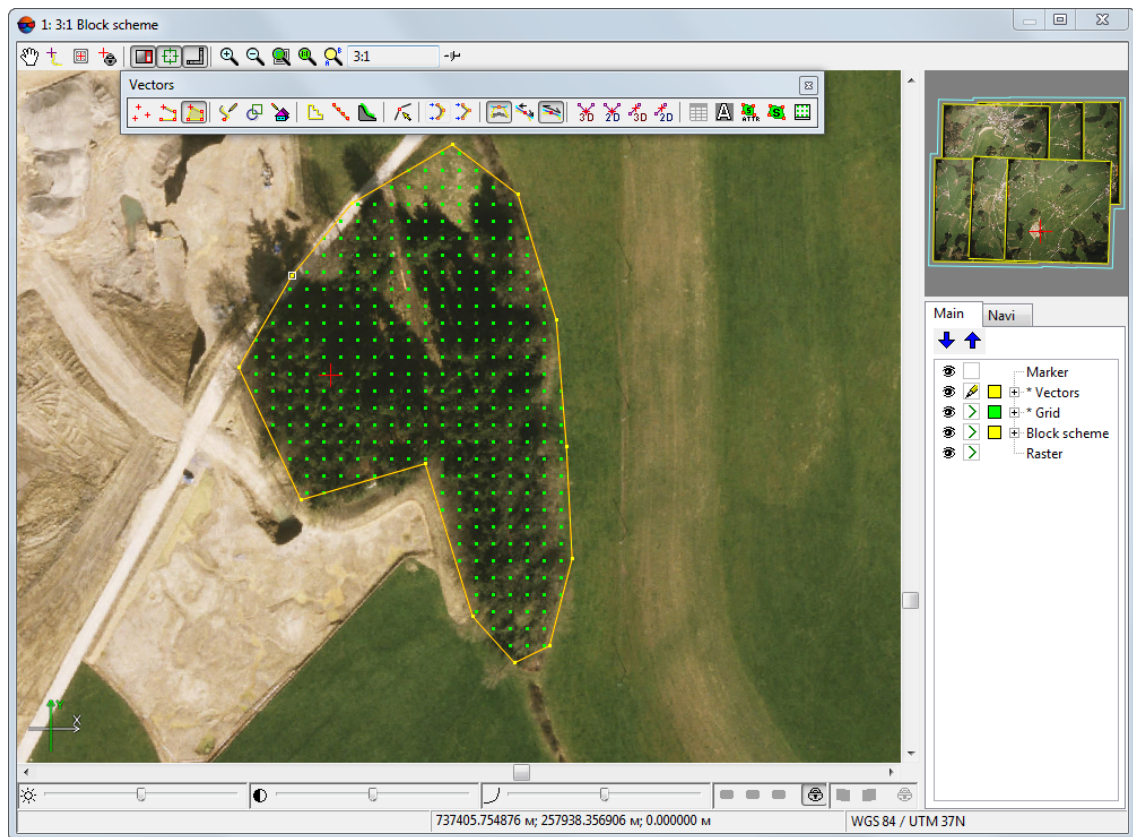



Fig. 121. Measuring grid creation

8. Make active the *Grid* layer in the *Manager*.
9. Choose **Vectors** › **Pathway** › **Activate** or click the  button of the **Pathway mode** additional toolbar (detailed description of Pathway mode see in the “DTM Generation” User Manual). After that marker is placed to the first grid node.
10. If grid node is on the top of tree, press **Enter** to create point in this node. Press **Delete** to skip a grid node. Passing to the next grid node is performed automatically.



To pass to the previous grid node, press the **Backspace** key.

11. After passing of all grid nodes the system displays the “*Pathway complete*” message.



The system also provides possibility to create points on the grid manually in frames of polygon without pathway mode. At that it is necessary to comply with the positioning accuracy of points in XY plane for the grid nodes within 1/3 of the distance between grid nodes.

12. Make active the *Vector* layer in the *Manager*.

13. Choose **Vectors** > **Attributes** > **Calculate canopy of forest** or click the  button of the **Vectors** additional toolbar.

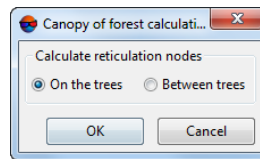

Fig. 122. Parameters of forest cover canopy

14. To calculate canopy value select **Calculate of reticulation nodes – On trees**. To calculate a value inverse to canopy select **Calculate of reticulation nodes – Between trees**.



It is better to create points *between* trees in case of high trees density. In this case choose **Between trees** to calculate cover canopy.

15. Click OK. After that the system displays a message with information about value of forest cover canopy.

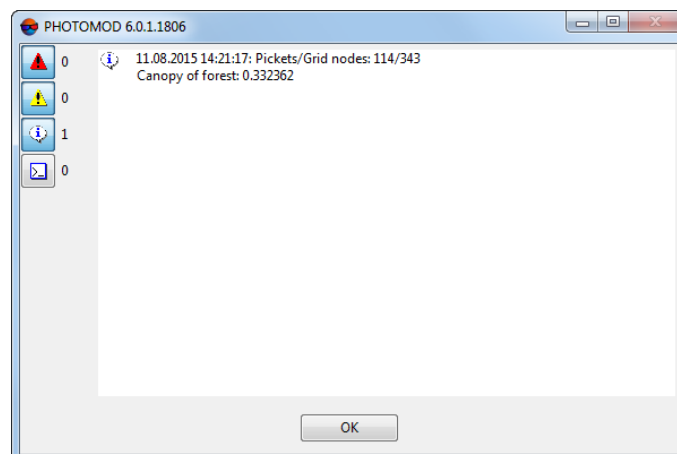













Fig. 123. Forest cover canopy value



8. Operations with vector objects

8.1. The “Edit” menu

The system provides possibility to edit objects in a layer, to change marker position or vectorization and selection modes and other operations of vector layer editing. The **Edit** menu allows to do this.

Table 10. Brief description of the “Edit” menu

Menu items	Function
Group selection	contains menu items to choose mode of vector object selection
Snapping	contains menu items for processing in the snapping mode (see the Section 3.4.6)
Vectors create mode	contains menu items to change mode of vector object creation: points, polyline, polygons, and creating mode of polylines and polygons as smooth lines (see Section 5.3)
Curve transforms	menu items to create and edit smooth curve lines (see Section 8.6)
 Undo (Ctrl+Z)	to cancel the last operation of vector objects editing on a layer (see Section 8.7)
 Undo log	to open the Undo log containing a list of recent editing operations
 Redo (Ctrl+Shift+Z)	to redo the last undone operation (see Section 8.7)
 Points editing mode	to move common vertices of objects together (see Section 8.4.1)
 Streamline mode (Y)	to enable streamline mode of linear objects input (see Section 3.4.4)
 Snap-to-ground mode (T)	to enable snap-to-ground mode
 Orthogonal mode (A)	to enable orthogonal mode of linear objects input
 Orthogonal mode in coordinate system	to enable orthogonal mode of linear objects input in additional coordinate system
 Add coord system	to create additional (user) coordinate system as a helping vectorization tool
Edit coord system	to change default axes direction of additional coordinate system
 Delete coord system	to delete additional coordinate system
Alignment mode	turns the alignment mode on
Scale when align	to scale vector objects during their transformation in the alignment mode
Rotation mode	turns the fast vector objects transformation mode on
Select vertices when marker moves over them	to select a vertex, located in marker area on a distance specified in the Swath field (Service > Settings > Vectors)
Move marker to selected vertex	to move marker to the selected vertex automatically (see the “Settings of vector objects display” chapter of the “ General system’s parameters ” User Manual)
Sync markers	to turn on/off synchronous marker moving in all opened 2D-windows
 Copy marker to clipboard (Ctrl+Alt+INS)	to copy position of marker in 2D-window to clipboard

Menu items	Function
 Paste marker from clipboard (Ctrl+Alt+INS)	to move marker to position in 2D-window copied to clipboard
Cancel selection	to unselect all objects in active 2D-window (see Section 8.2)
Invert selection	to invert objects selection in active 2D-window (see Section 8.2)
Select all (Ctrl+A)	to select all objects in active 2D-window (see Section 8.2)
Highlight selected objects	to highlight vector objects selected in 2D-window (see Section 8.2)
Fit to window current layer	to display the data of the current layer completely. This function is supported by all types of layers (see section "Image scaling in 2D-window" in " General information " User Manual)
Active layer	contains menu items to work with current active layer (see the " General information " User Manual)
Show/hide labels in all layers (Ctrl+Shift+H)	to configure curves smoothing (see Section 8.6.6)
Toggle Raster layer visibility in Stereopair window	to show/hide the Raster layer when working in the stereopair window, duplicates the  button in the <i>Layer manager</i>



When working with vector objects in the stereopair window, for ease **Toggle Raster layer visibility in Stereopair window** function use it is recommended to set an appropriate hotkey (see the "[General information](#)" User Manual).

8.2. Vector objects selection

8.2.1. Objects selection tools

Objects on active vector layer could be selected both manual and automatically.

To select object manually are used the following tools:

- mouse double click or the **S** key to select single polyline/polygon;
- one mouse click to select point near to marker;
- **rectangle** – select objects inside of rectangle;
- **polygon** – select objects inside of free form polygon.

To highlight objects on active vector layer **inside a rectangle** choose **Edit › Group selection › Rectangle** or click the  button of the **Tools** toolbar. Press and hold the **Shift** key and drag a rectangle by mouse.

To select objects **inside of free form polygon** perform the following:

1. Choose **Edit › Group selection › Polygon** or click the  button of the **Tools** toolbar.
2. Press and hold the **Shift** key. Then make mouse click to create the first polygon vertex and a “rubber line” directed to current cursor position. Input subsequent vertices by mouse clicks.
3. To complete objects selection by polygon use mouse double click. To break off selection, press the **Esc** key.

To select all objects of active vector layer choose **Edit › Select all** or use the **Ctrl+A** hotkeys.









The **Edit › Highlight selected objects** menu item allows to highlight selected objects in 2D-window using additional lighting.



If selected objects have attributes in the table of **Objects attributes** window displays only attributes with the same values. Strings of attributes with different values highlights by red color.

8.2.2. Objects selection modes

To change selecting mode for vector objects the system provides the **Edit › Group selection** menu items:

-  **Rectangle** – to select objects inside a rectangle;
-  **Polygon** – to select objects inside arbitrary polygon;
-  **Normal** – during vector objects selection previously selected objects will be unselected;
-  **Add to selection** – each newly selected object (objects group) is added to a group of selected objects;
-  **Subtract from selection** – allows to unselect selected object (objects group);
-  **Invert selection** – allows to invert selected objects (objects group);
-  **Fully inside** – allows to select objects that hit the selection area;
-  **Partly inside** – allows to select objects in which one or more segments intersects a border of selection area;
-  **At least one point inside** – allows to select objects in which at least one vertices are in the selection area;

















The **Tools** panel partially duplicates menu items **Edit › Group selection**.

The **Vectors > Selection** menu contains the following items used to sequentially select vector objects and their vertices:

- **Select previous object (Ctrl+<)** – allows to select an object, previous to selected;
- **Select next object (Ctrl+>)** – allows to select an object, next to selected;
- **Select previous line vertex (<)** – allows to select a polyline vertex located before the selected one; sequence of vertices is displayed when you select a vector object (see [Section 5.3.8](#));
- **Select next line vertex (>)** – allows to select a polyline vertex located after the selected one; sequence of vertices is displayed when you select a vector object (see [Section 5.3.8](#));

To unselect objects press **Esc**.

Table 11. Brief description of the Tools toolbar



Button	Function
	to select vector objects inside a rectangle
	to select vector objects inside arbitrary polygon
	during vector objects selection previously selected objects will be unselected
	each newly selected object (objects group) is added to a group of selected objects
	to unselect selected object (objects group)
	to invert selected objects (objects group)
	to select objects that hit the selection area
	to select objects in which one or more segments intersects a border of selection area
	to select objects in which at least one vertices are in the selection area
	turns the alignment mode on
	to scale vector objects during their transformation in the alignment mode
	turns the fast vector objects transformation mode on
	to copy position of marker in 2D-window to clipboard
	to move marker to position in 2D-window copied to clipboard
	to paste vector objects from clipboard to active vector layer into marker position



Vector objects are pasted to the point of marker position at the time of copying objects to the clipboard. If the marker is not moved between the copy and paste operations, objects are located in the same coordinates as the original; otherwise they shift on a vector that connects marker positions during copy and paste operations.

8.2.3. Selecting classifier layer object

During work in a layer with classifier the system provides the following options for automatic objects selection:

- selection of all layer objects – select a layer in the list of the **Classifier** window and click the  button; all objects of selected layer are highlighted in 2D-window (see [Section 6](#)).
- selection of objects with specified code – select necessary code in the codes list of the **Classifier** window and click the  button; all objects with specified code are highlighted in 2D-window (see [Section 6](#)).

8.3. Vector objects copying

The system provides possibility to copy all, highlighted or selected by type objects of vector layer to defined or new vector layer.

To copy objects of vector layer perform the following actions:

1. Make vector layer active.
2. [optional] To copy objects to existing layer, open this vector layer. Vector layer with objects to be copied should be active.
3. Select **Vectors** > **Copy to layer**. The **Copy objects to another layer** window opens.

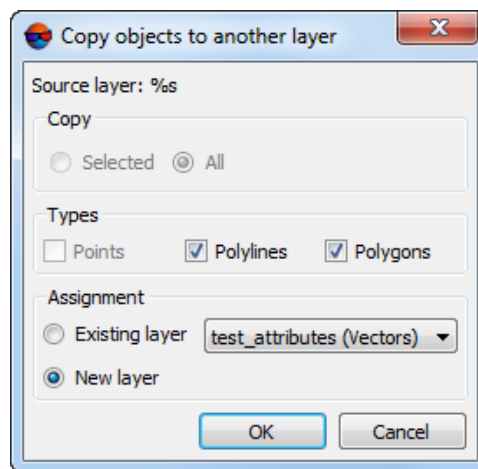

Fig. 124. Parameters of objects copying to layer

4. To copy just selected objects, in the **Copy** section choose **Selected**, otherwise, choose **All** (default setting).
5. In the **Types** section choose one or more object types to copy:
 - **Points**;
 - **Polylines**;

- **Polygons.**
6. In the **Destination** section choose a layer to copy object:
 - **Existing layer** – choose one from the list of opened layers;
 - **New layer.**
 7. Click OK to copy objects.



The system also allows to create several copies of vector object placed at the *same layer* (see [Section 11.4.6](#))

The system also allows using of clipboard for vector layer editing.

The **Vectors** › **Clipboard** › **Copy (Ctrl+C)** menu item allows to copy **selected** vector objects to the clipboard.

The **Vectors** › **Clipboard** › **Paste (Ctrl+V)** menu item allows to paste vector objects from clipboard to active vector layer.

The **Vectors** › **Clipboard** › **Cut (Ctrl+X)** menu item allows to cut vector objects from active layer and copy them to clipboard.

The **Vectors** › **Clipboard** › **Paste into marker position (Ctrl+Shift+V)** menu item allows to paste vector objects from clipboard to active vector layer into marker position.



Vector objects are pasted to the point of marker position at the time of copying objects to the clipboard. If the marker is not moved between the copy and paste operations, objects are located in the same coordinates as the original; otherwise they shift on a vector that connects marker positions during copy and paste operations.

8.4. Vector objects editing

8.4.1. Vertices editing

The system provides the following editing operations both for point objects and for polylines/polygons vertices:

- **delete** – to delete selected point/vertex press **Delete**;
- **remove together with adjacent segments** – see [Removing vertices together with adjacent segments](#);
- **move** – to move selected point/vertex press **Ctrl**; In XY-plane point moves with mouse or arrow keys, by Z – with **Page Up**, **Page Down** hotkeys or by rotate mouse wheel;
- **move to marker position:**

- to move **point/vertices to marker position** is used the **Vectors › Geometry › Move point to marker (J)**;
- to move **marker to selected vertices** is used the **Vectors › Geometry › Move marker to selected point (~)**;
- to move **all vertices to marker height** select object and choose **Vectors › Geometry › Move to marker height (K)**.



Marker positioning to necessary position is performed manually (see [Section 3.4](#)) or using the **Markerwindow** by input coordinate values from keyboard.

- **line orthogonalization on vertex** – to move polygon or polyline vertex, connected to the selected one, use menu items **Vectors › Geometry › Orthogonalization forward (Ctrl+F)** and **Vectors › Geometry › Orthogonalization backward (Ctrl+B)**. The vertex is moved so that the angle at the selected vertex is a multiple of 90. During orthogonalization forward the system moves a vertex following the selected, and during orthogonalization backward – a vertex preceding the selected. Sequence of vertices is displayed when you select a vector object (see also [Section 5.3.4](#)).



If the **Edit › Point editing mode** parameter is selected, then moving common vertices is performed at the same time (see [Section 11](#)).



If the **Edit › Point editing mode** parameter is selected and some amount of vertices of different objects are “connected”, after that it is possible to edit them simultaneously using snapping to nodes option (see [Section 3.4.6](#)) and the menu item **Vectors › Geometry › Move to marker position**.

8.4.2. Adding vertices to a line segment

The system allows to add vertices into a polyline or polygon segment.

In order to insert a vertex to selected polyline/polygon, place marker to necessary position and press **Insert**.



If the **Edit › Point editing mode** parameter is selected, when inserting a vertex between two connected vertices located on the common border of several polygons, the new vertex is inserted into all of polygons.

8.4.3. Polyline moving

To move **selected polyline/polygon** press the **Ctrl** key. Move a polyline in XY plane using mouse or arrow keys. To move it by Z, use **Page Up**, **Page Down** keys or mouse wheel rotation;



If there are selected vertices in polylines, the system moves only these vertices, and not the entire polyline.



When moving an object, to **display a displacement vector** as a dashed line between the first and final marker positions, click the  button and set the appropriate checkbox in the **Vectors** section of the **Settings** window.

8.4.4. Polyline deleting

To delete selected polyline/polygon use the **Delete** key.

If there is selected vertex in selected polyline, this vertex deletes first, and after the next press of the **Delete** key the whole polyline will be deleted.

8.5. Vector objects interpolation

8.5.1. Quick linear vector objects interpolation

Operation of “fast” objects interpolation is used to smooth the angles of *linear* vector objects and is applied, when the accuracy and quality of results are not significant. The operation consists of moving vertex of polyline to the middle of the adjacent segment.



Positions of the first and the last vertices of a polyline remain the same. Thus, each **Fast interpolation** of a polyline results in a new vertex added.



Applying this operation to polygons is not recommended

To execute fast interpolation perform the following actions:

1. Select **Vectors** > **Interpolate** > **Quick interpolate**. The **Fast interpolation** window opens:

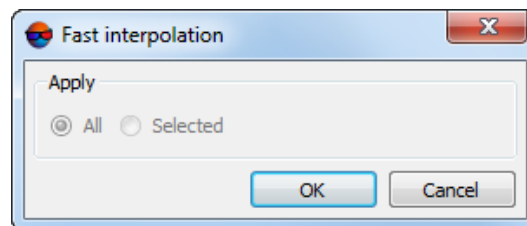

Fig. 125. Quick interpolation parameters

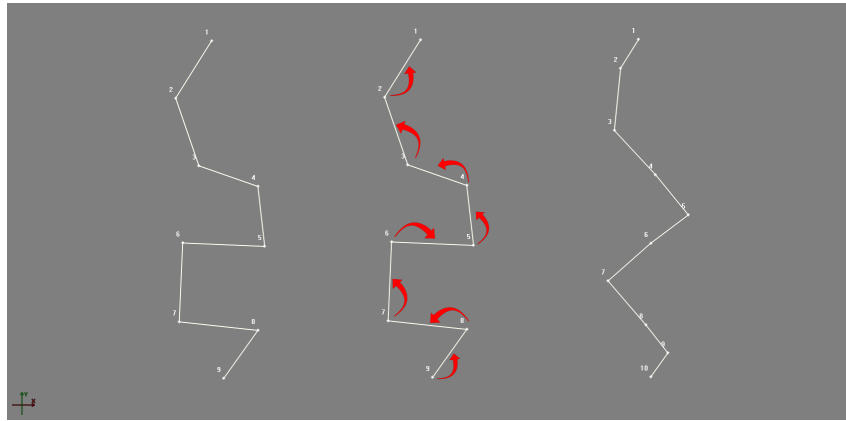

Fig. 126. Quick interpolation scheme

2. [optional] Select **Selected** to interpolate selected objects only, otherwise, select – **All**;
3. Click OK to apply the interpolation.

8.5.2. Corners round off

The system provides for vector object corner round off through the increase of vertex number.



The system also provides for **vector object corner round off** without change of their vertex number.



Vector object corner round off is often used while editing the contour lines (see the “Contour lines” chapter of the “DTM Generation” User Manual).

To perform the round off corners at vertices of vector objects perform the following actions:

1. Select **Vectors › Interpolate › Round off corners**. The **Settings** window opens:

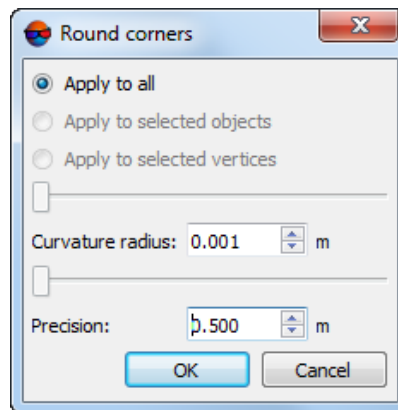

Fig. 127. Parameters of vector objects corners round off

2. Select objects to round off their corners:

- **Apply to all** – allows to round off corners of polylines/polygons;
- **Apply to selected objects** – allows to round off corners of selected polylines/polygons only;
- **Apply to selected vertex** – allows to round off corners of selected polylines/polygons only;

3. Move slider or input the **Curvature radius** for smoothing curve;



The smaller the radius, the closer the smoothing curve to initial polyline vertices.

4. Specify in the input field or using the **Precision** slider the precision parameter – maximal distance from polyline segment to a curve in the area between the two closest vertices;



Change the **Curvature radius** and **Precision** values using appropriate sliders to display results of round off operation in real time. That is why the sliders are enabled only when there is a single selected object, in order to avoid start of a long calculation process.

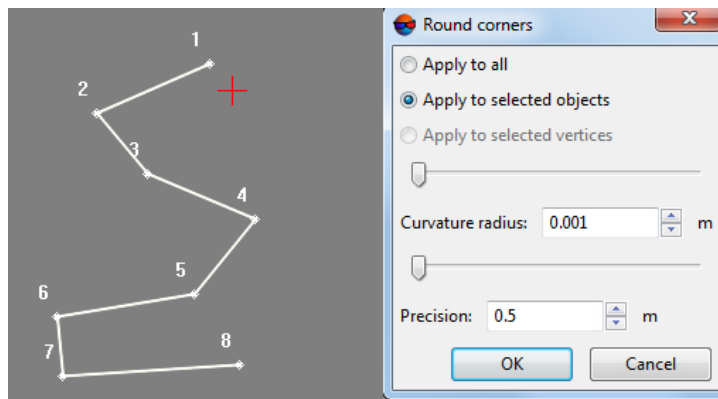

Fig. 128. Parameters of vector objects corners round off

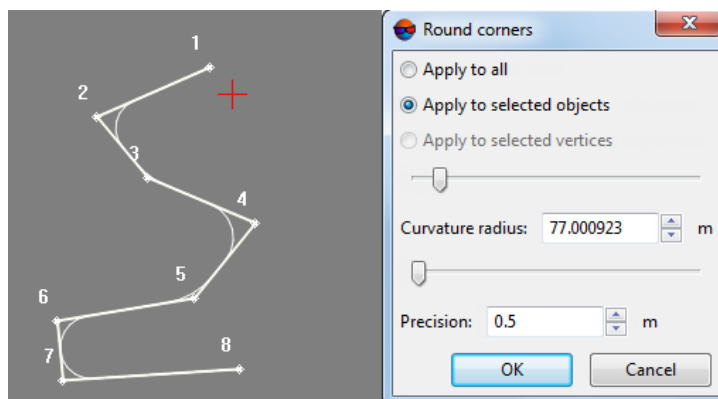

Fig. 129. Round off operation preview

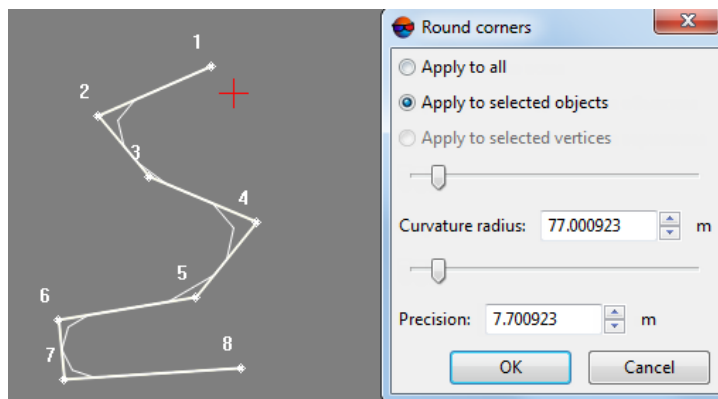

Fig. 130. Round off operation preview

5. Click OK. After that the corners near vector objects vertices are round off considering specified parameters.

8.5.3. Vertices thinning out

The operation is used to reduce the number of vertices in all or selected vector objects.

To perform thinning out vectors vertices perform the following actions:

1. Select **Vectors** › **Interpolate** › **Thin out polylines**. The **Thinning parameters** window opens:

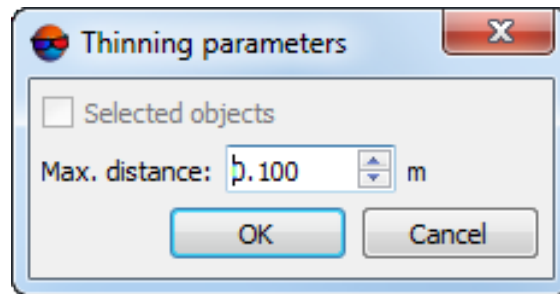

Fig. 131. Parameters of linear objects thinning out

2. [optional] Set the **Selected objects** checkbox on to thin out vertices for selected objects only;
3. In the **Max. distance** field specify distance between two adjacent vertices. If vertices located closer than a specified distance, one of vertices is deleting;
4. Click OK. After that operation the vector objects vertices located closer to each other than the specified distance are removed.

8.5.4. Interpolation by Bezier curve

During interpolation polylines/polygons are smoothed by adding additional vertices along calculated Bezier curve.

Perform the following actions to perform interpolation of polylines/polygons:

1. Select **Vectors** › **Interpolate** › **Interpolate**. The **Settings** window opens:

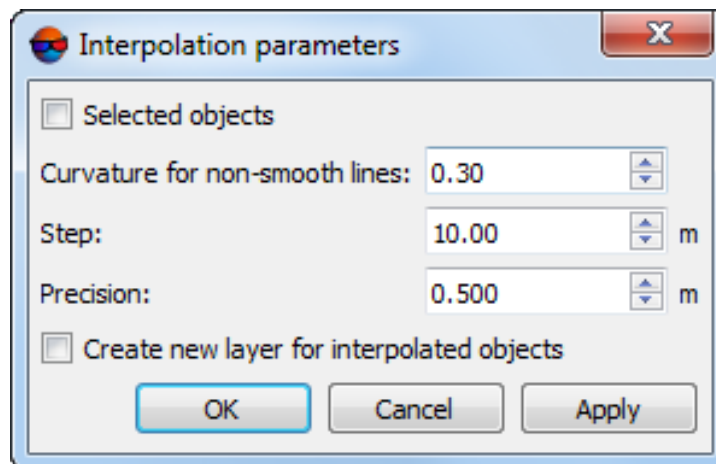

Fig. 132. Parameters of polyline interpolation

2. In the **Curvature for non-smooth lines** field specify the degree of curvature of the Bezier curve;



Recommended values range is from 0.1 to 1.0.

3. In the **Step** field specify the distance between the polyline vertices approximating the Bezier curve;
4. In the **Precision** field specify maximal distance from the Bezier curve to polyline approximating it. At a distance greater than the specified, additional vertices are added to a polyline until the condition is satisfied;
5. [optional] To interpolate selected objects only, set the **Selected objects** checkbox on, otherwise, this operation will be performed for all objects;
6. [optional] To save the interpolation results to a separate layer, set the **Create new layer for interpolated objects** checkbox on;
7. [optional] Click **Apply** to preview interpolation results;

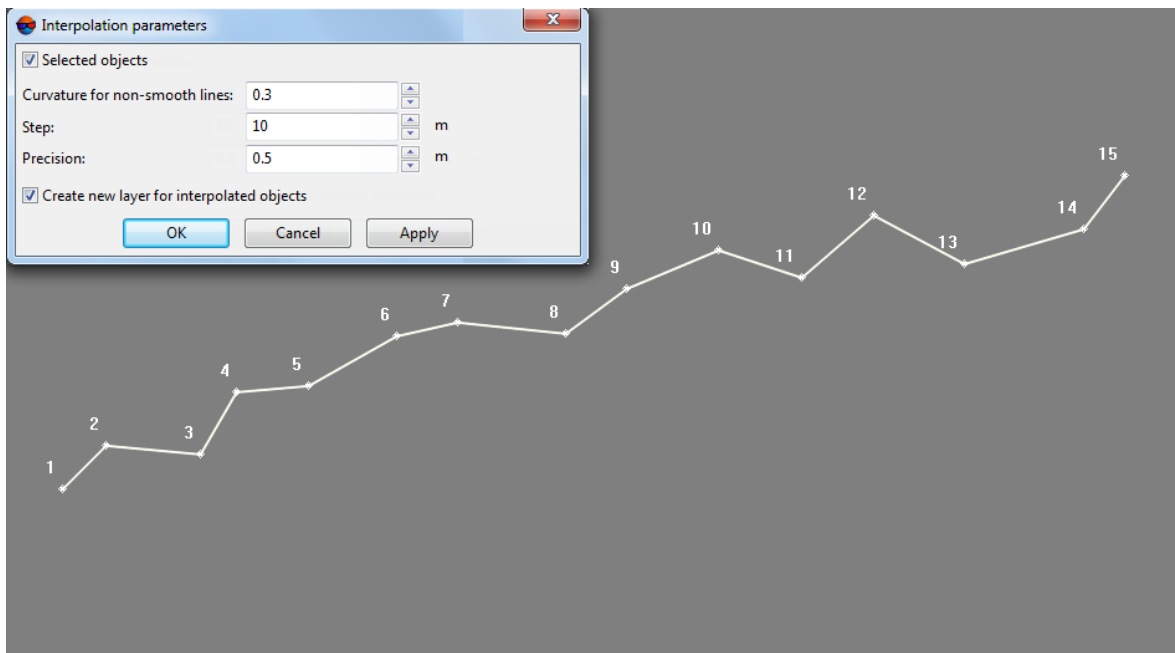

Fig. 133. Parameters of polyline interpolation

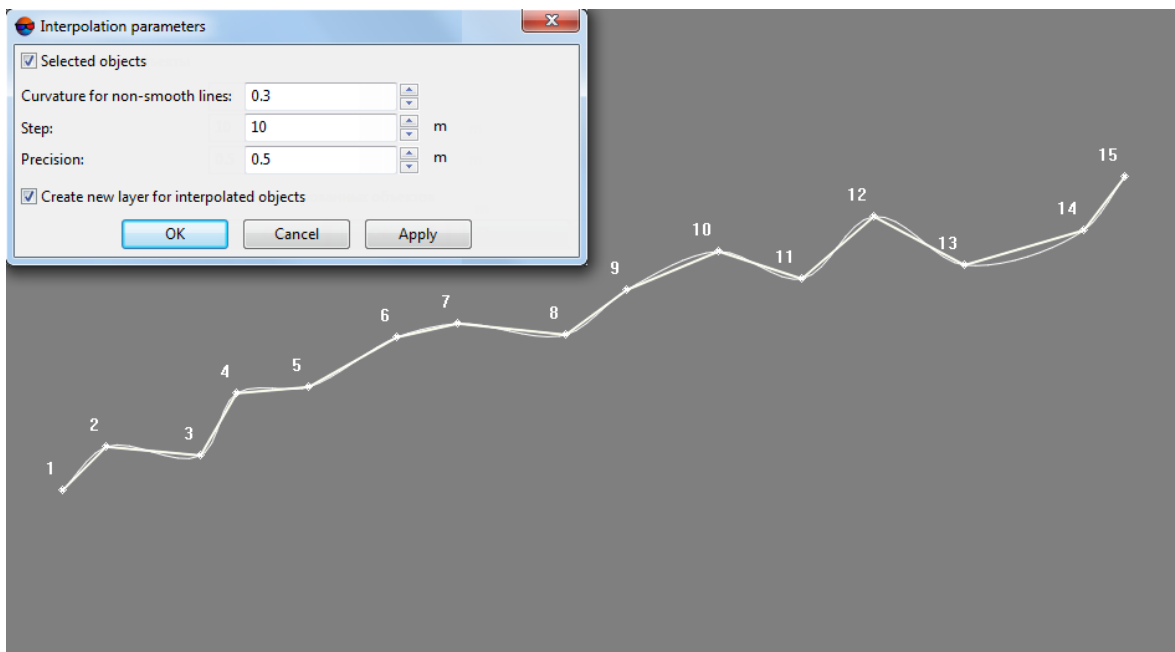

Fig. 134. Interpolation results preview

8. Click OK to perform interpolation of vector object.

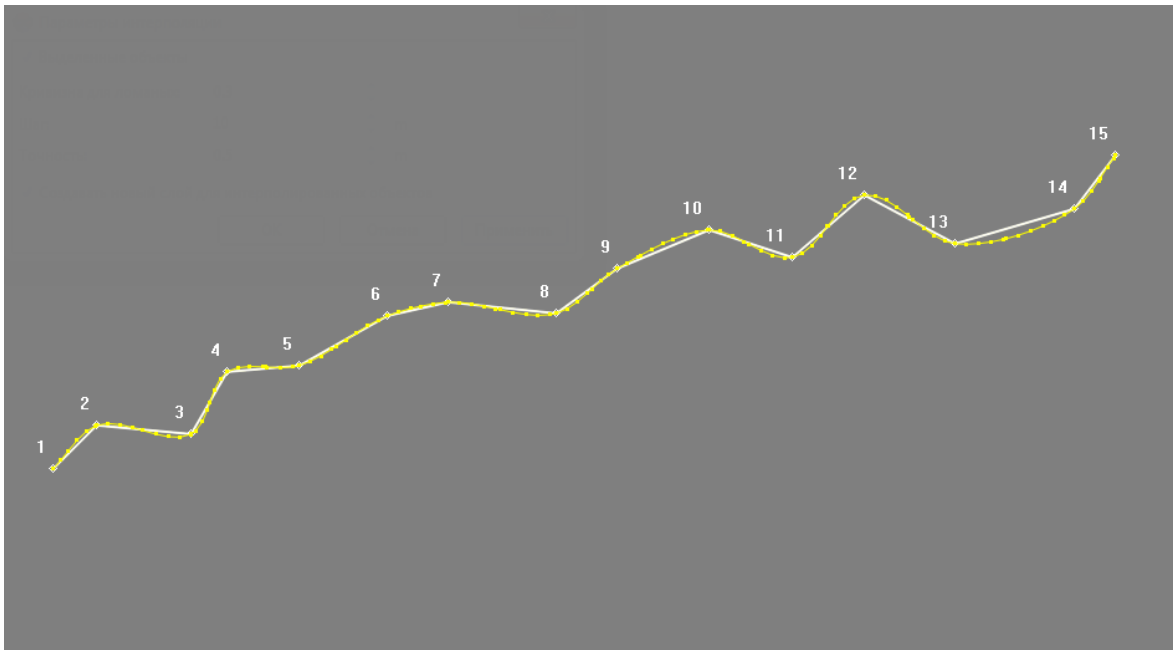

Fig. 135. Interpolation results in new layer

8.5.5. Elevations interpolating

When perform vectorization of linear objects on the terrain, which relief uniformly changes, it is possible to use interpolation of polylines/polygons by their elevation.

Perform the following actions to do this:

1. After polyline creation choose **Vectors** > **Interpolate** > **Interpolate elevations**. The **Z interpolation** window opens:

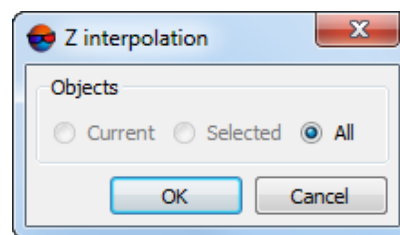

Fig. 136. The Z interpolation window

2. Choose objects for interpolation:
 - **Current** – selected object chosen by double-click; displayed with bold line in a 2D-window;
 - **Selected** in 2D-window objects;

- **All** objects.
3. Click OK. Elevations of vertices located between the start and end points are interpolated proportional to the distance between the intermediate vertices and the difference in elevation between the start and end vertices.

8.5.6. Convolution smoothing

The system provides possibility to perform convolution smoothing to reduce the probability of the intersections obtained during interpolation of contours generated from TIN.



Convolution is performed for each coordinate axis. Each axis described as a function of the length of the polyline with the kernel specified using **Exponential** or **Gaussian** methods.



Vector object corner round off is often used while editing the contour lines (see the “Contour lines” chapter of the “DTM Generation” User Manual).

To smooth contour lines using convolution, perform the following actions:

1. Select **Vectors** > **Interpolate** > **Convolution smoothing**. The **Convolution smoothing** window opens.

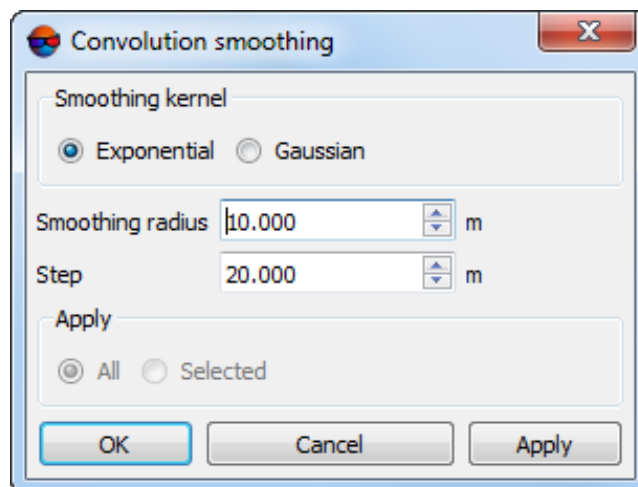

Fig. 137. Parameters of convolution smoothing

2. Select smoothing method: **Exponential** or **Gaussian**.
3. Define the following parameters of smoothing:
 - Corner **smoothing radius** (between segments of the original object);



An angle can be rounded by inscribing a circular arc of a given radius in it. The smaller the radius, the closer the smoothing curve to initial polyline vertices.

- **Step**, to specify the characteristic distance between vertices.



Step affects the number of additional vertices created.

4. [optional] In the **Apply to** section select **Selected** to smooth selected objects only, otherwise, select – **All** (by default).
5. [optional] Click **Apply** for contour smoothing preview. Change smoothing parameters if needed;



This function is available only when there is a single selected object, in order to avoid start of a long calculation process.

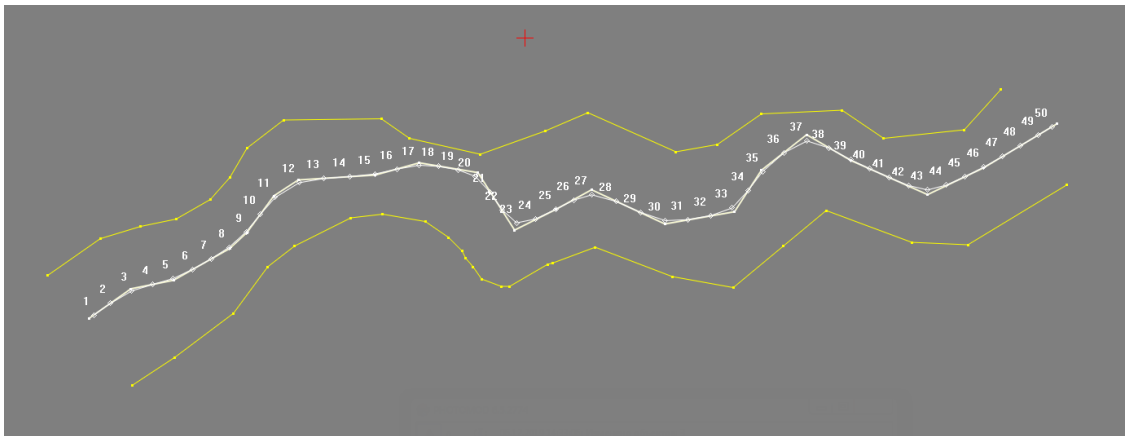

Fig. 138. Convolution smoothing preview

6. Click OK. The system performs smoothing operation.

8.5.7. Smoothing vector objects

To smooth a shape of vector objects, perform the following actions:

1. [optional] **Select** all the vector objects to which it's necessary to applied a smoothing procedure.
2. Choose **Vectors** › **Interpolate** › **Smooth**. The **Smooth objects** window opens.

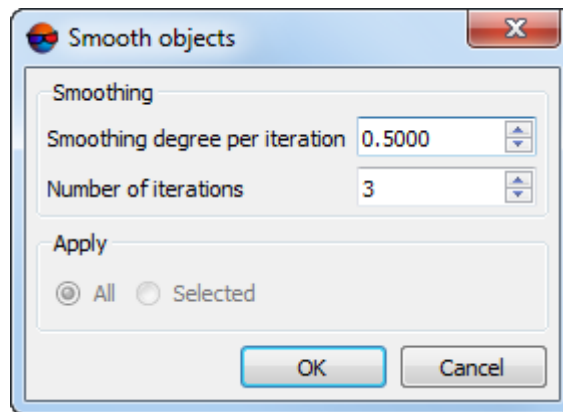

Fig. 139. Parameters of smoothing vector objects

3. In **Smoothing** section set parameters of smoothing vector objects:
 - **Smoothing degree per iteration** – the maximum value of **Smoothing degree per iteration** – 1;
 - **Number of iterations** – the maximum value is 100;
4. In **Apply** section select objects to which a smoothing is applied:
 - **All** – allows to smooth all the vector objects;
 - **Selected** – allows to smooth selected polylines/polygons only.
5. Click OK. As a result vector objects are smoothed with parameters specified.

8.5.8. Vertices densification

The system provides possibility of vector objects vertices densification.

To do this perform the following:

1. Choose **Vectors** › **Interpolate** › **Densify objects**. The **Vertices densification** window opens:

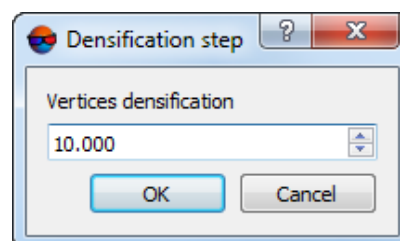

Fig. 140. Vertices densification parameters

2. Input **densification step** – the *typical* distance between vertices;
3. Click OK.





8.6. Editing of smooth curves

8.6.1. The “Curve transforms” menu

The system allows to create and edit **smooth curve lines**.

To do this there are menu items **Edit › Curve transforms** and buttons of the **Vectors** additional toolbar (see [Section 5.1](#)).

Table 12. Brief description of the “Curve transforms” menu

Menu items	Function
 Convert polygonal chains to curves	to convert selected broken lines to smooth ones (see Section 8.6.3)
 Convert curves to polygonal chains	to convert selected smooth curves to broken lines (see Section 8.6.3)
 Resmooth on editing	to recalculate automatically smoothing of curve line segments during object editing (see Section 8.6.4)
 Edit control nodes	to enable curve check points editing (see Section 8.6.5)
 Smooth editing of curve control nodes	to preserve smoothing during editing of curve check points (see Section 8.6.5)
Curves smoothing	to configure curves smoothing (see Section 8.6.6)

8.6.2. Smooth curves creation mode

The system provides smooth curves creation mode.

To create smooth curves choose **Edit › Vector create mode › Curves** or click the  button of the **Vectors** additional toolbar.

Smooth curves creates as ordinary polylines (see [Section 5](#)). When work with [classifier](#) object code with L (line) type should be selected.

To perform automatic curve smoothing during its creation select **Edit › Curve transforms › Resmooth on editing** or click the  button of the **Vectors** additional toolbar.

8.6.3. Conversion of smooth curves

The system provides opportunity to convert selected broken lines to smooth curves and vice versa.

To perform conversion of selected broken lines to smooth curves is used the **Edit › Curve transforms › Convert polygonal chains to curves** menu item and the  button of the **Vectors** toolbar.

To convert selected smooth curves to broken lines is used the **Edit › Curve transforms › Convert curves to polygonal chains** menu item and the  button of the **Vectors** toolbar.

8.6.4. Automatic smoothing

The system provides opportunity to automatically change the degree of the curve smoothing, while its creating or editing.

[optional] To do this select **Edit › Curve transforms › Resmooth on editing** or click the  button of the **Vectors** additional toolbar. During any editing of smooth curve vertices using markers of nodes control the smoothness of the curve does not change.

8.6.5. Editing of curve line segments

The system provides possibility to edit curve line segments. To enable such mode select **Edit › Curve transforms › Edit control nodes (X)** or click the  button of the **Vectors** additional toolbar. The position of the segments of created smoothed curves is edited by pressing **Ctrl** key and by right mouse button, using “traction” of markers of polyline vertices control.

To switch the option of angles forming when editing the curve segments, select **Edit › Curve transforms › Smooth editing of curve control nodes** or click the button of the **Vectors** additional toolbar.

8.6.6. Smoothing control

The system provides possibility to smooth existing curves.

To change smoothing degree perform the following actions:

1. Choose **Edit › Curve transforms › Curves smoothing**.

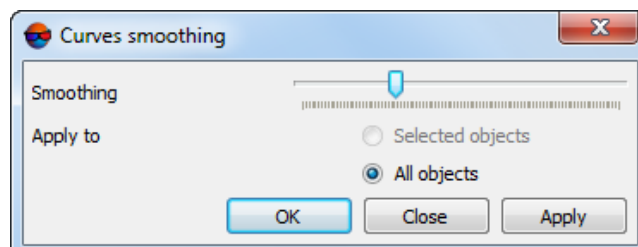





Fig. 141. Curves smoothing degree

2. Set the smoothing degree using the appropriate slider.
3. [optional] Choose objects to transform: to **Selected objects** or to **All objects**.
4. Click **Apply** to show changes in 2D-window. Click OK to complete operation.

8.7. Undo editing operations

The system allows to undo edit operations of vector objects, and also to redo recently undone operations (see the “[General information](#)” User Manual).

To cancel the last operation of vector objects editing, select **Edit › Undo (Ctrl+Z)** or click the  button of the main toolbar. To redo the last undone operation of vector objects editing, select **Edit › Redo (Ctrl+Shift+Z)** or click the  button.

In order to open the recent editing operations list select **Edit › Undo log** or click the  button.

To cancel a group of operations double click in the **Undo log** on line with action to which you want to undo changes. Lines with undone operations are marked by italic font. To redo all undone operations, double click the line with action to which you want to redo changes.

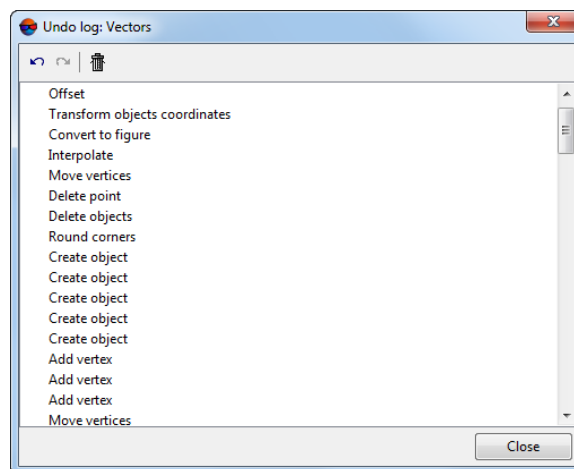



Fig. 142. Undo log

To clear log is used the  button. After that undo and redo actions become unavailable.



List of undo operations is maintained for each layer separately.

The undo log clears automatically in the following cases:

- after exceeding of information volume about operations list;

- when you start the large volume of automatic transformations or calculations (for example, during creation contour lines using large volume data source).



In these cases the system displays a warning that it will be impossible to cancel the transformations.



When working with a fair amount of vector objects using of undo mode slows down editing operations. To increase the performance, disable the undo log creation (see the “[General system’s parameters](#)” User Manual).

8.8. Additional coordinate system

The system allows to create additional (user) coordinate system which is used as a helping vectorization tool together with **Snapping to coords** function:

- To create additional (user) coordinate system select **Edit › Add coord system** or click  button in **Vectors toolbar**. Axes direction of the additional coordinate system is shown at the left bottom corner of 2D-window;
- To change default axes direction of additional coordinate system perform the following:
 1. Select **Edit › Edit coord system** or click  button in **Vectors toolbar** to turn on mode of editing user coordinate system;
 2. Set X axis direction of the additional coordinate system while using **Polylines (L) mode** (draw one segment line, vertices of which are specified X axis direction). Axes direction of the additional coordinate system will be changed according to the specified one. Edit coord system mode will be turned off automatically.
- To delete additional coordinate system select **Edit › Delete coord system** or click  button in **Vectors toolbar**.

The system allows to add to the marker *guides* in the form of red and green dash lines which are co-directed with the active (main or additional) coordinate axes. The red line is aligned with the X-axis, and the green one is aligned with the Y-axis. The guides enable us to assess mutual alignment of the objects on images.

To add guides to the marker select **Service › Settings**. The **Settings** window opens. On the **Windows** tab of the **Settings** window set the **Coord lines under marker** checkbox.

The system also allows to rotate the marker crosshair according to the additional coordinate system axes (see the “Marker settings” chapter in the “[General system’s parameters](#)” User Manual).

9. Vector objects filtering

To edit vector objects the system provides the following filters:

- **Filter by Z-range** – filtering points and vertices of polylines/polygons, which Z-coordinate is out of specified range;
- **Median Z filter** – filtering points and vertices of polylines/polygons using mask of specified size;
- **Filter adjacent point objects** – filtering of closely located points (located nearer than specified distance);
- **Linear objects filtering** – filtering polylines/polygons, that linear size (coordinates range by one of axes) is more or less of specified value;
- **Surface objects filter** – filtering points, which have fallen on particular tall objects or pits of specific size.

The set of filters used for editing vector objects partially coincides with the instruments for points filtering (**Terrain** › **Points** › **Filter** menu, see “Points filtering” section of the “DTM Generation” User Manual).

9.1. Points filtering by Z-range

The system provides possibility to remove points and vertices of polylines/polygons, which Z-coordinate falls outside specified range.

To perform objects filtering of active vector layer by elevations range, execute the following actions:

1. Select **Vectors** › **Filter** › **Filter by Z-range**. The **Z-range filter** window opens.

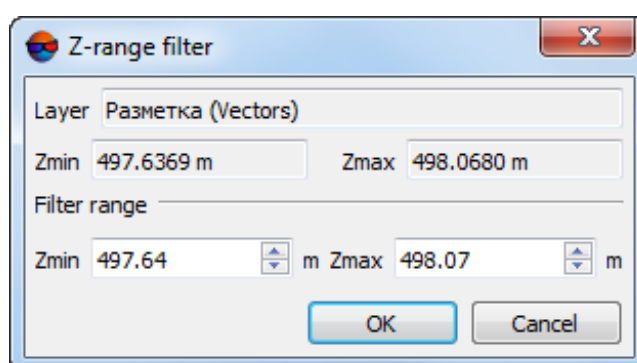

Fig. 143. Parameters of points filtering by Z

The **Layer** field displays a name of selected active vector layer, the **Zmin** and **Zmax** fields show terrain elevation difference in meters, calculated by all layer objects.

2. The **Filter range** section by default shows values of calculated terrain elevation difference. Specify maximal and minimal Z values in meters to consider for points/vertices filtering.
3. Click OK. Filtration removes all points and vertices of polylines/polygons, which Z-coordinate falls outside specified range. When the filtering operation is completed the system displays information message about number of deleted points.

9.2. Median points filtering by Z

The system provides possibility of median filtering to remove single sharp spikes in presence of smooth relief.

The *median filtering* contains the following sequence of actions:

1. Sequential scanning of area with vector objects by window-mask. Scanning step is specified as window-mask halfsize.
2. Deleting points which elevation is out of range.



The range is calculated as average level of vectors elevation that fall into mask. When calculating the range the system considers specified deviation from average level.

To execute median filtering perform the following actions:

1. Select **Vectors** > **Filter** > **Median Z-filter**. The **Median Z filter** window opens.

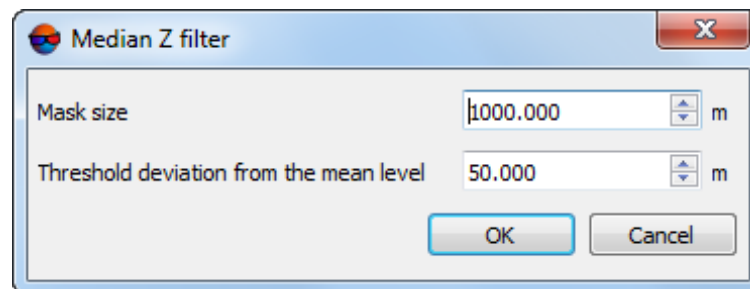

Fig. 144. Parameters of median points filtering

2. In the **Mask size** field specify a side size of scanning square window-mask in meters.
3. In the **Threshold deviation from the mean level** field specify deviation by Z in meters from mean level of objects elevation in the mask.
4. Click OK. Filtration removes all points and vertices of polylines/polygons, which Z-coordinate falls outside specified range. When the filtering operation is completed the system displays information message about number of deleted points.

9.3. Filter of adjacent point objects

Filter of adjacent point objects allows to remove points, in which vicinity there are other objects located closer specified distance.

To filter adjacent points on active layer perform the following actions:

1. Select **Terrain › Points › Filter › Filter adjacent point objects**. The **Filter adjacent point objects** window opens.

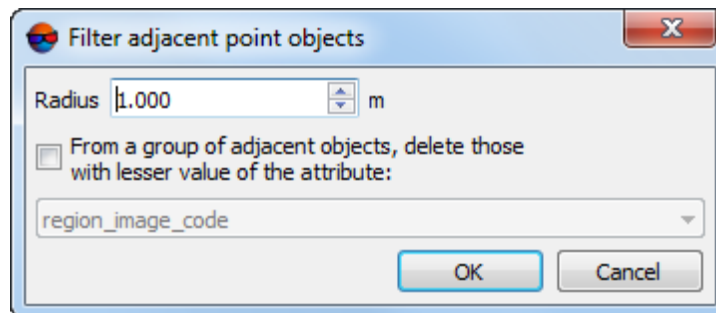

Fig. 145. Parameters of adjacent point objects filter

2. Specify the **Radius** – maximal distance in meters to each point, and if a points falls closer that the radius value, the points is deleted.
3. [optional] In order to delete from two points just one which contains the smallest value of one attribute (for example, if points vector layer was created in automatic points calculation mode with preserving of quality assessment in attributes), set the **From a group of adjacent objects, delete those with lesser value of the attribute** checkbox on and select in the list an attribute to be considered during points removal.
4. Click OK. Filtration removes points, between which the distance is less than specified. When the filtering operation is completed the system displays information message about number of deleted points.

9.4. Filtering of linear objects

The system provides the possibility to delete vector object whose length (perimeter) or linear dimension (i.e. the range of coordinates along one of the axes) do not match the specified value.

To use filtering of linear objects perform the following actions:

1. Select **Vectors › Filter › Selective delete objects**. The **Delete lines** window opens;

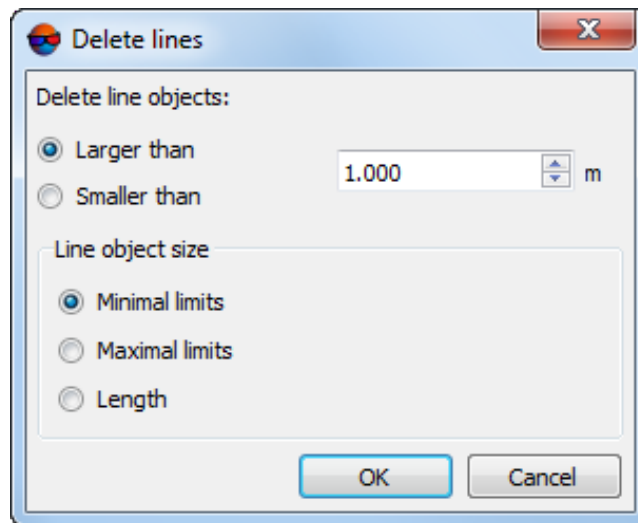

Fig. 146. Parameters of linear objects filtering

2. Set size of objects to be deleted (in meters);
3. Select filtering method:
 - **Larger than** – used to delete objects, size of which exceeds the specified value (in meters);
 - **Smaller than** – used to delete objects, size of which is less than specified value (in meters).
4. In the **Line object size** section select the size calculation method:
 - **Length**;
 - **Minimal limits / Maximal limits** – linear size (by one of the axes).
5. Click OK. Filtration removes all linear objects with size that is more or less than specified.

9.5. Surface objects filter

The system provides possibility to correct blunders of correlation, obtained, for example, during automatic points calculation. The **Surface objects filter** allows to delete points located on terrain surface with specified **typical size** by XY and Z.



This filtering type is not used for objects of completely built-up area, forest belts and similar objects.

The principle of filtering is to estimate the location and size of the contours created using TIN, which was generated with help of initial points. A surge is a group of contours that is not greater than specified size by XY and with elevations in specified range.



Surface objects filter is recommended to use to eliminate sharp spikes. For more fine filtering it is recommended to use this filter along with buildings and vegetation filter (see the “DTM Generation” User Manual).

To apply filter of objects on surface perform the following actions:

1. Select **Vectors** › **Filter** › **Surface objects filter**. The **Surface objects filter** window opens.

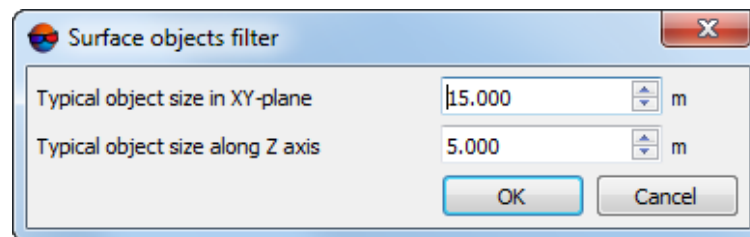

Fig. 147. Parameters of surface objects filter

2. Specify the **Typical object size in XY-plane** and **Typical object size along Z axis** in corresponding fields in meters.
3. Click OK to remove points found.

10. Geometric transformations of vector objects

Table 13. Brief description of the “Geometry” menu

Menu items	Function
Move point to marker	to move point/vertices to marker position (see Section 8.4.1)
Move marker to selected point	to move marker to selected vertices (see Section 8.4.1)
Delete points around polylines	to delete points used for the TIN creation around linear objects (see Section 10.4.1)
Delete points inside polygons	to delete points inside polygons. Points and polygons could be located both in one layer and different (see Section 10.4.2)
Swap X <-> Y	to swap X and Y coordinates of vector objects (see Section 10.5.1)
Convert coordinate system	provides opportunity of coordinates recalculation from one coordinate system to another for all vertices of current layer (see Section 10.5.2)

Menu items	Function
Move	provides possibility both to move vector objects by a predetermined vector using X, Y, Z coordinates, and to set a predetermined elevation without vectors movement (see Section 10.1)
Move to marker height	to move all vertices of the object to marker height (see Section 8.4.1)
Transform...	to perform geometric transformation of vector objects: rotation by the angle and scaling (see Section 10.1.8)
Projective transform...	to perform projective transformation of vector objects (see Section 10.1.11)
Convert to figure	provides opportunity to convert arbitrary polygons into standard geometric shapes: ellipse, round, rectangle, square, orthogonal polygon (see Section 10.1.3)
Convert polygons to points	to convert all or selected polygons into point objects (see Section 10.1.2)
Cut objects by selected polygons	provides the possibility of cutting vector objects of one layer by the boundaries of polygons of another layer (see Section 10.1.5)
Cut objects around selected	to cut vector objects around selected vectors placed at the same layer (see Section 10.1.6)
Convert all vertices to point objects	provides possibility to convert all vertices both of polylines, and polygons to point objects (see Section 10.1.2)
Split into layers by object type	to split objects into layer depending on their <i>type</i> (see Section 10.1.7)
Buffer zone...	to create a <i>buffer zone</i> – a polyline/polygon parallel to selected line and situated at a predetermined distance from it (see Section 10.2.3)
Buffer zone to marker	to perform the fast <i>buffer zone</i> creation (see Section 10.2.3)
Objects around points...	to create circles with defined radius or squares with defined side length around vertices of linear objects (see Section 10.2.4)
Vectors profiles...	provides the function of construction of perpendicular profiles through the group of linear vector objects (see Section 10.2.5)
Surface area of polygons	provides possibility to calculate polygon surface area taking into account the vertices height (see Section 10.8)
Correct by residuals...	to perform operation of vector layer correction using residuals vectors is intended to clarify the position of vector objects (see Section 10.1.4)
Elevation Profile	to create an elevation profile of a linear object (in the form of chart, whose vertices are the vertices of a polyline, see Section 10.7)

Menu items	Function
Vertical DEM profile along selected line	to build a DEM elevation profile along a linear object (see the “Building DEM elevation profile along a linear object” chapter of the “DTM Generation” User Manual)
Add intersection points	provides the ability to automatically add a vertex at the intersection of vector objects (see Section 10.2.1)
Symmetric objects	contains menu items to to create symmetrical lengthy objects both linear and areal (see Section 10.2.2)
Orthogonalization forward / Orthogonalization backward	to move polygon or polyline vertex, connected to the selected one (see Section 8.4.1)
Project on stereomodel	provides possibility to project vector objects on relief of active stereopair (see Section 10.3)
Project on TIN	to project vector objects on TIN (see Section 10.3.2)
Project on DEM...	to automatically assign elevation marks to points with known XY coordinates from loaded DEM (see Section 10.3.3)
Cut CSV file by rectangle edges	to delete from CSV-file points out of defined boundaries (see Section 10.6)
Cut CSV file by selected polygons	to cut CSV file by selected polygons (see Section 10.6)
Check orthogonality	provides possibility to check orthogonality of polygons corners (see Section 10.2.6)

10.1. Transformation of vector objects

10.1.1. Vector objects moving

The system provides possibility both to move vector objects by a predetermined vector using X, Y, Z coordinates, and to set a predetermined elevation without vectors movement.

In order to move vector objects perform the following actions:

1. Select **Vectors** › **Geometry** › **Move**. The **Move objects** window opens.

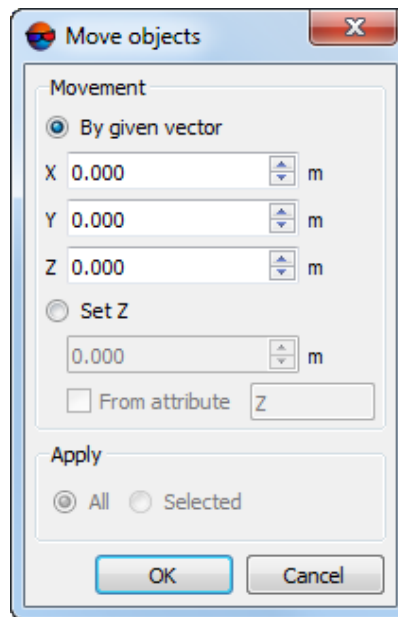

Fig. 148. Parameters of objects moving

2. Select one of the following ways of moving:
 - **By given vector** – specify X, Y, Z values (in meters), that define a size of moving vector;
 - **Set Z** – set Z value (in meters) to move objects to specified elevation.



To set zero value double-click on selected field.

3. [optional] Select **Selected** in the **Apply** section, to move selected objects only, otherwise, select **All**.
4. Click OK. After that vector objects are moved to specified distance or elevation.

10.1.2. Converting polygons to points

The function polygons to points conversion is intended for conversion of all or selected polygons into point objects.



The code with P (points) type should be selected to perform operation in the vector layer with classifier. Otherwise conversion couldn't be performed.

To perform the conversion, select **Vectors > Geometry > Convert polygons to points**. If there is selected objects in the layer, both all and only selected objects could be converted.

As a result of the operation the polygons are replaced by point objects. These points are placed in the mass centers of the boundaries of the original polygons. In the layer with classifier selected code is assigned to new point objects and all attributes of source linear objects.

The system also provides possibility to convert all vertices both of polylines, and polygons to point objects. To perform the conversion, select **Vectors › Geometry › Convert all vertices to point objects**. The new vector layer containing point objects is created.

10.1.3. Conversion of vector object to geometric shape

The system provides opportunity to convert arbitrary polygons into standard geometric shapes:

- ellipse;
- round;
- rectangle;
- square;
- orthogonal polygon.

In order to convert active layer polygons into geometric shapes perform the following actions:

1. Make vector layer active.
2. Select **Vectors › Geometry › Convert to figure**. The **Parameters** window opens.

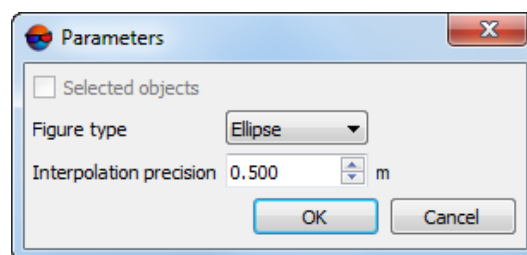

Fig. 149. Parameters of vector object conversion into geometric shape

3. [optional] Set the **Selected objects** checkbox on to convert only to selected polygons. Otherwise, all polygons are converting.
4. Define the following parameters:
 - **Figure** for conversion;

- **Precision** for conversion.



The system allows to approximate vector objects presented in the form of curves by broken lines. This approximation precision, that is maximal distance from the broken line segment to the curve between two closest vertices, is specified by user. This parameters default value is 0.5 in measurement units of current project (usually in meters).

5. Click OK. Polygons convert to selected geometric shape with specified approximation precision.

10.1.4. Correcting by residuals vectors

The operation of vector layer correction using residuals vectors is intended to clarify the position of vector objects.

To perform vector layer correction using residuals vectors, execute the following actions:

1. Open the layer with residuals vectors (linear objects).



Residuals vector layer should be create, for example, by [measuring](#) of residuals on points manually. To create a new vector layer set the **Save measurements in layer** checkbox on in the **Measurement** window.

2. Open the layer to be corrected.
3. Select **Vectors > Geometry > Correct by residuals**. The **Settings** window opens.

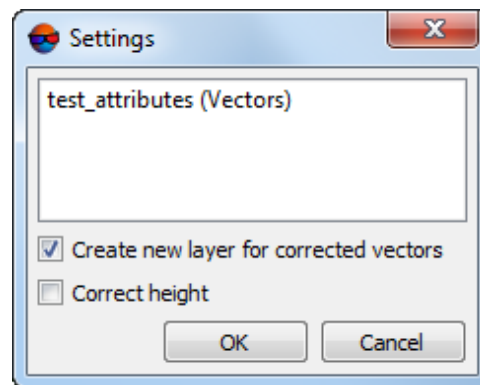

Fig. 150. Parameters of correcting by residuals vectors

4. Select a layer with residuals vectors in the list.
5. [optional] To correct objects in active layer, set the **Create new layer for corrected vectors** checkbox off. Otherwise new vector layer creates.

- [optional] To change not only XY coordinates, but also the height, set the **Correct height** checkbox on.
- Click OK. The new vector layer containing corrected vectors is created.

10.1.5. Cut vectors by selected polygons

The system provides the possibility of cutting vector objects of one layer by the boundaries of polygons of another layer. Perform the following actions to do this:

- Open a layer with polygons to be used as borders, or make this layer editable.
- Select polygons to be used as boundaries.
- Select **Vectors** > **Geometry** > **Cut objects by selected polygons**.

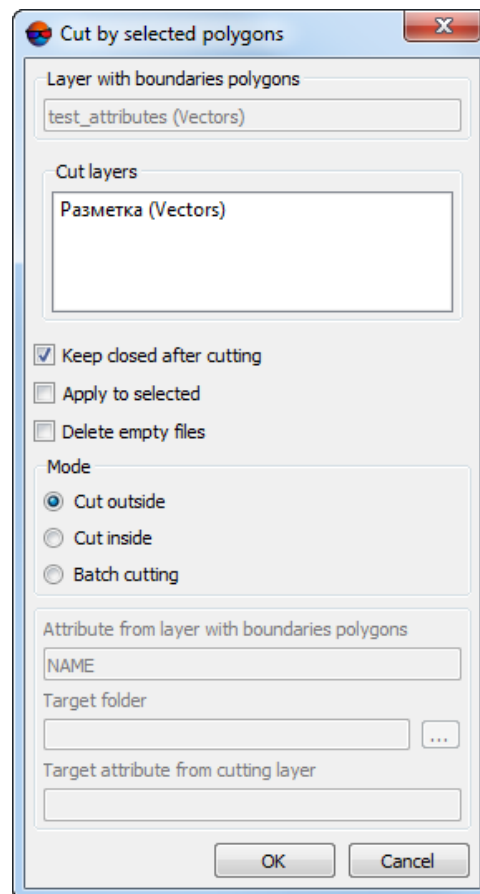

Fig. 151. Parameters of cutting by boundaries

- In the **Cut layers** list select a layer with objects to be cut.
- [optional] In order to not to close the polylines after cutting automatically, set the **Keep closed after cutting** checkbox off.

6. [optional] To apply the operation to selected objects only, set the **Apply to selected** checkbox on.
7. Leave the **Delete empty files** checkbox clear;
8. Select **mode**:
 - **Cut outside** – to cut vector objects located out of selected polygons;
 - **Cut inside** – to cut vector objects located inside the selected polygons;
 - **Batch cutting**.
9. Click OK. After that the system removes all objects of the layer specified, that are located outside the selected boundary.

Batch vector cutting by selected polygons

The system allows for batch cutting of vector objects within one layer by polygon boundaries within other layer.

The batch cutting results in creation of new vector layers each of which contains objects cut by the internal boundary of one of enclosing polygons. The initial layer containing the objects to be cut remains unchanged.

This function can be used e.g. to cut notation sheets by the image block scheme. To do this, perform the following:

1. Choose **Block > Create vector layers from block layout** in order to create a *Block scheme* vector layer that displays image boundaries (see more details in the “Creating vector layers from block layout” chapter of the “[Creating project](#)” User Manual).

The polygons located in the *Block scheme* vector layer have the following automatically specified attributes:

- **Name** of attribute – *Label*;
- **Type** of attribute – *text*;
- Attribute **value** – *Image_name*.



If polygons used as boundaries have no attributes, [create](#) attributes before batch cutting.

2. Create a separate vector layer with [notation sheets](#).

Notation sheets created by generators of splitting into sheets have the following automatically specified attributes:

- **Name** of attribute – *Name*;
- **Type** of attribute – *text*;
- Attribute **value** – *Sheet_name*.



If vector objects for batch cutting have no attributes, [create](#) attributes before batch cutting.

3. Make the layer with polygons to be used as boundaries editable;



In given case this is the *Block Scheme* layer.

4. Select polygons to be used as boundaries;
5. Choose **Vectors** > **Geometry** > **Cut objects by selected polygons**;

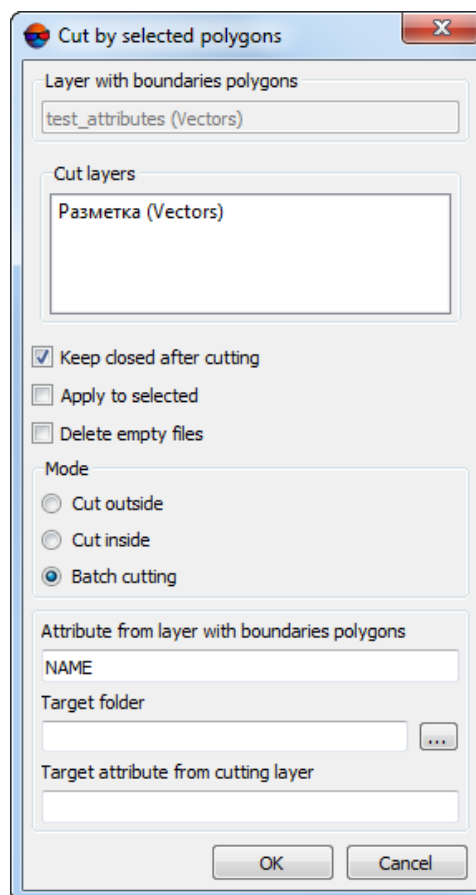

Fig. 152. Parameters of batch cutting by polygons

6. [optional] In order not to close cut notation sheets with image boundaries, clear the **Keep closed after cutting** checkbox;
7. Select the **mode - Batch cutting**;
8. Set the **Delete empty files** checkbox to not create blank files for those polygons, within which vector objects intended for cutting will not be found. Otherwise, vector files will be created for all selected polygons, including “blank” ones, i.e. not containing any vector objects.
9. Input the **Attribute from layer with boundaries polygons**;



In given case this is the name of the attributes of polygons displaying image boundaries – *Label*.

10. In the **Target folder** field, click the button and select the folder in the active profile resources where the output vector layers are to be saved.



In given case, these are cut notation sheets as separate layers for each image boundary.

Names of output vector layers are to be set automatically from the object attribute values used as boundaries for cutting.



In given case, it is the *Label* attribute value, i.e. names of the images on the borders of which the cutting takes place.

11. Input the **Target attribute from cutting layer**;



In given case, this is the name of the attributes of polygons displaying notation sheets – *Name*.

12. Select a layer with objects to be cut in the **Cut layers** section and press Ok.



If a layer with objects to be cut was created but not previously saved, a window opens where the system suggests to save it before operation execution.

В целевой папке создаются выходные векторные слои, содержащие (в данном примере) обрезанные номенклатурные листы, замкнутые границами изображений, в случае если флажок **Keep closed after cutting** не был снят.

Output vector layers that contain (in given case) cut notation sheets are created in the target folder. The cut notation sheets are closed by image boundaries if the **Keep closed after cutting** checkbox was not cleared.

Cut notation sheets have automatically specified attributes, as follows:

- **Name** of attribute – *Name*;
- **Type** of attribute – *text*;
- Attribute **value** – Image_name_Sheet_name.



Cut notation sheets keep their attributes only if they are polygons (i.e. the **Keep closed after cutting** checkbox was not cleared).

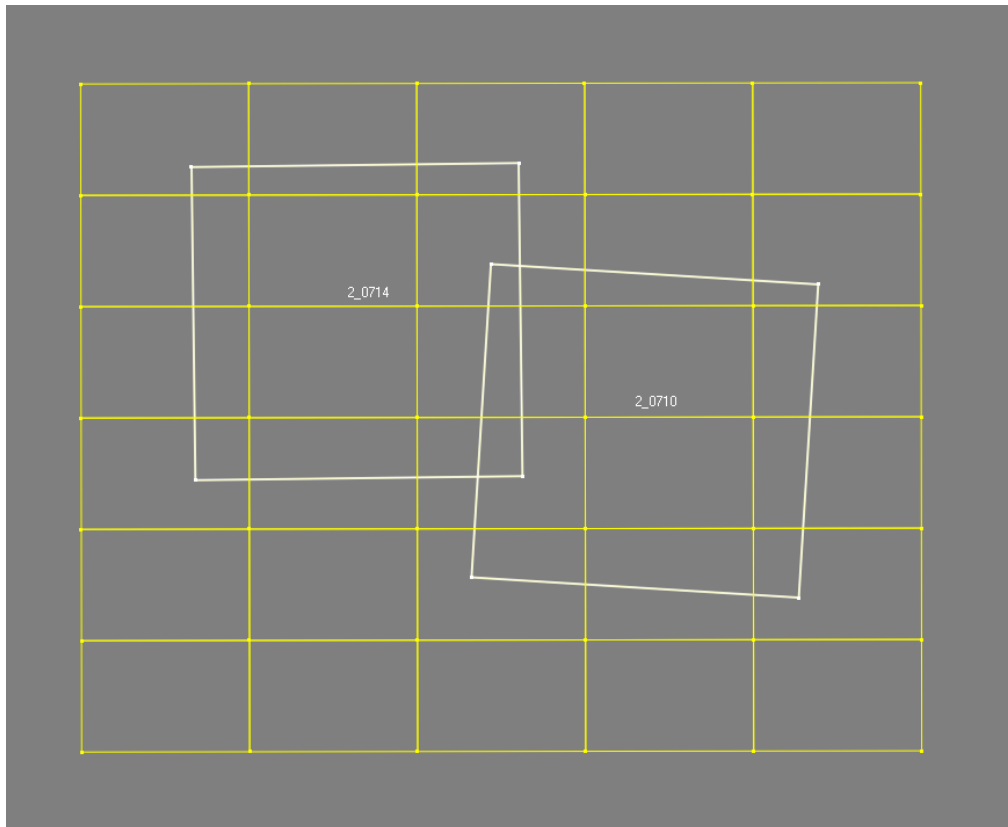

Fig. 153. Image boundaries (highlighted) and notation sheets

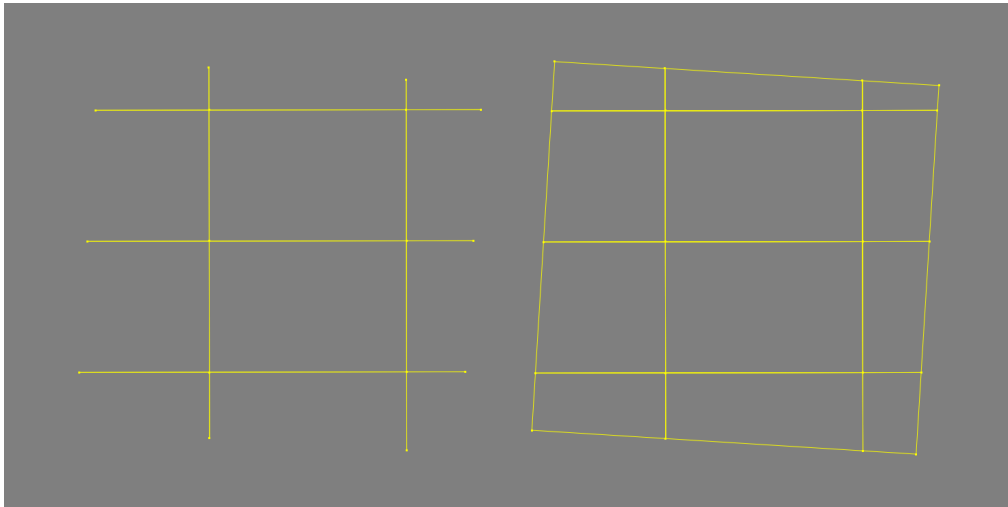

Fig. 154. Open (left) and closed (right) cut notation sheets

10.1.6. Cutting objects around selected vectors

The system allows to cut vector objects around selected vectors placed at the same layer. To do this, perform the following:



The function is available for all types of vector objects.

1. Load or create a layer with vector objects;
2. **Select** vector objects around which it's necessary to cut all the other vector objects of the given layer.
3. Выберите **Vectors** › **Geometry** › **Cut objects around selected**.

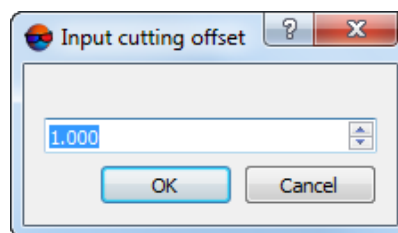

Fig. 155. Parameters of cutting objects around selected ones

4. **Input cutting offset** around vertices and segments of the selected objects in meters.
5. Click OK. As a result, in the current vector layer all the point object and segments of polylines/polygons placed inside a cutting offset are deleted.



In case of cutting vector objects around polygon, a cutting offset is placed both out of polygon and in it.

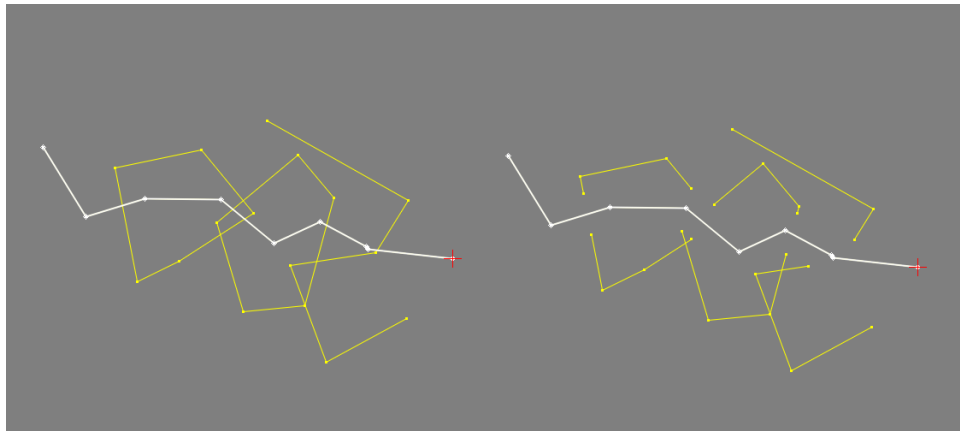

Fig. 156. Cutting vector objects around selected object

10.1.7. Splitting objects into layers depending on type

The system allows to split objects into layer depending on their [type](#).

The **Vectors** › **Geometry** › **Split into layers by object type** menu item is used for that. If the layer contains only one type, the system displays an appropriate message. In other cases two or three new layers are created, each of which contains only one type of objects.

10.1.8. Vector objects transformation

The system allows to perform geometric transformation of vector objects: rotation by the angle and scaling.



The system also allows to perform geometric transformation of vector objects in [alignment mode](#).



The system also allows to perform [fast](#) geometric transformation of vector objects.

To do such transformation perform the following actions:

1. [Select](#) objects to be transformed.
2. Select **Vectors** › **Geometry** › **Transform** › **Transform....** The **Geometrical transform of selected objects** window opens.

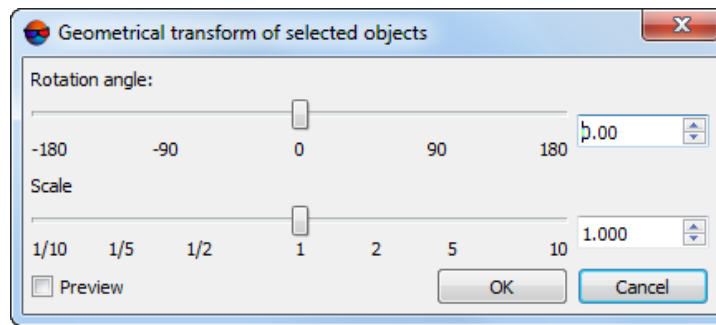

Fig. 157. Parameters of geometric objects transformation

3. Move sliders to set the following parameters:
 - **Rotation angle** – the value is set in degrees, in range from -180 to 180;
 - **Scale** – is changed from 1/10 to 10 times.
4. [optional] To disable preview mode of transformation in real time, set the **Preview** checkbox off. It is recommended to set it off when working with a large number of vector objects to increase the system performance.
5. Click OK. After that all selected vector objects are transformed in accordance with selected parameters without change of elevation value.

To rotate vector objects *manually* in *arbitrary* angle, perform the following:

1. **Select** objects to be transformed.
2. Select **Vectors** › **Geometry** › **Transform** › **Rotate**.
3. Press and hold **Ctrl** key and move *mouse cursor* to the point considered as a possible rotation center of the object. *No moving a cursor* press and hold **left mouse button**. Keeping **Ctrl** key and **left mouse button** rotate vector object with moving mouse.
4. Turn off parameter **Vectors** › **Geometry** › **Transform** › **Rotate**.



The system allows to rotate a specific vertex of the object. To do it, perform actions similar to the actions mentioned above with selecting an object vertex.



The system allows to rotate specific segments of the object. To do it perform actions similar to the actions mentioned above with preliminary selecting parameter **Edit** › **Point editing mode** and choosing vertices to which specific segments of the object adjoin.

To scale vector objects manually, perform the following:

1. **Select** objects to be transformed.

2. Choose **Vectors › Geometry › Transform › Scaling**.
3. Press and hold **Ctrl** key and move *mouse cursor* to the point considered as a possible scaling center of the object. *No moving a cursor* press and hold **left mouse button**. Keeping **Ctrl** key and **left mouse button** perform scaling vector object with moving mouse.
4. Turn off parameter **Vectors › Geometry › Transform › Scaling**.



Performing this function to the object selected vertex will provide a scaling of the object part which includes a vertex selected and segments adjoining to it.





To scale specific segments of the object, perform actions similar to the actions mentioned above with preliminary selecting parameter **Edit › Point editing mode** and choosing vertices to which specific segments of the object adjoin.

10.1.9. Fast vector objects transformation

The system allows to perform fast geometric transformation of vector objects: rotation by the angle and scaling.

To do such fast transformation perform the following actions:

1. Choose **Edit › Rotation mode** or click the  button of the **Tools** toolbar to enable the *fast vector objects transformation mode*;
2. **Select** objects to be transformed. The point considered as a possible scaling/rotation center of the object () would be created automatically;

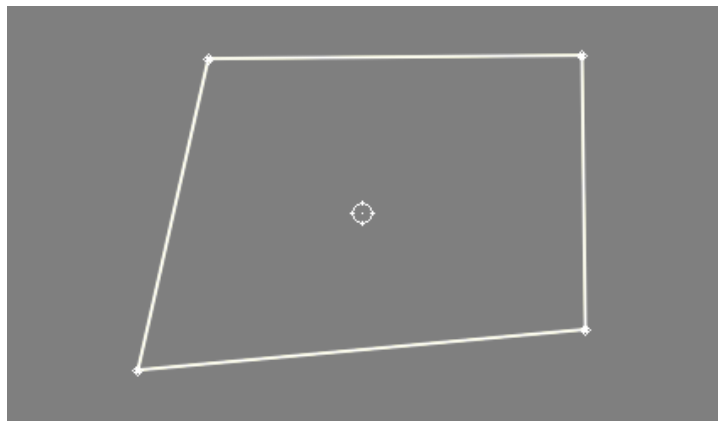

Fig. 158. The polygon selected in fast vector objects transformation mode

3. [optional] Press and hold **Ctrl** key and move *mouse cursor* to the point considered as a possible scaling/rotation center of the object. *No moving a cursor* press and hold **left mouse button**. Keeping **Ctrl** key and **left mouse button** perform relocation of this point with moving mouse;

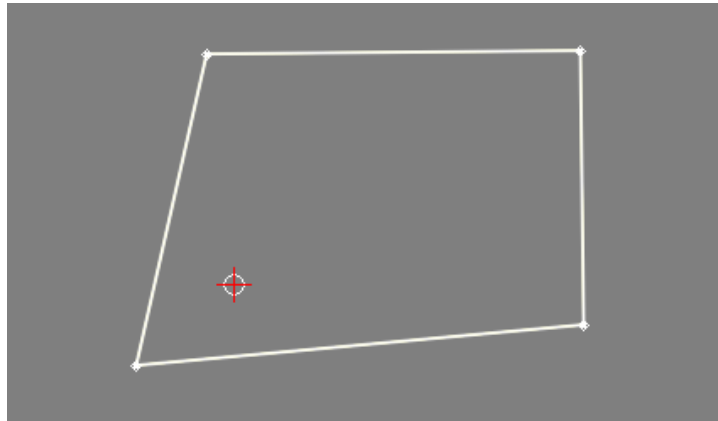



Fig. 159. Relocation of the point considered as a possible scaling/rotation center of the object

4. [optional] Keeping **Alt** key and **left mouse button** perform vector object movement in XY plane with moving mouse;
5. [optional] Keeping **Ctrl** key and **left mouse button** perform scaling/rotation of vector object with moving mouse.



To perform the vector object rotation and vector object scaling *separately* the **Transform** menu items are used (**Vectors** › **Geometry** › **Transform**).

6. Choose **Edit** › **Rotation mode** or click the  button of the **Tools** toolbar to disable the *fast vector objects transformation mode*;

10.1.10. Alignment mode

The system enables for geometric transformations of objects in the alignment mode. The **alignment mode** allows to perform simultaneously the following operations with vector objects:



- rotate and scale one vector object relative to another;
- moving (connecting) vector objects on the plane and heightwise.



Connecting is the process of vector object moving so that at least one vertex of one object completely coincide on the plane with another object's vertex (see also the "Contours connecting" section of the "[DTM Generation](#)" User Manual).

To perform geometric transformation of vector objects in the alignment mode, do the following:

1. **Create** or open a layer containing at least two vector objects;

2. In order to enable the **Alignment mode**, select **Edit › Alignment mode** or click the  button of the **Tools** toolbar;
3. [optional] To scale vector objects during their transformation in the alignment mode, select **Edit › Scale when align** or click the  button of the **Tools** toolbar;
4. [optional] To connect vector object both on the plane and heightwise, select **Service › Settings › Vectors** and set the **Change Z of aligned object** checkbox;
5. Select *two* vertices of the object chosen for geometric transformation using the **left mouse button** (labels 1 and 2 will appear in the vicinity of the selected vertices).

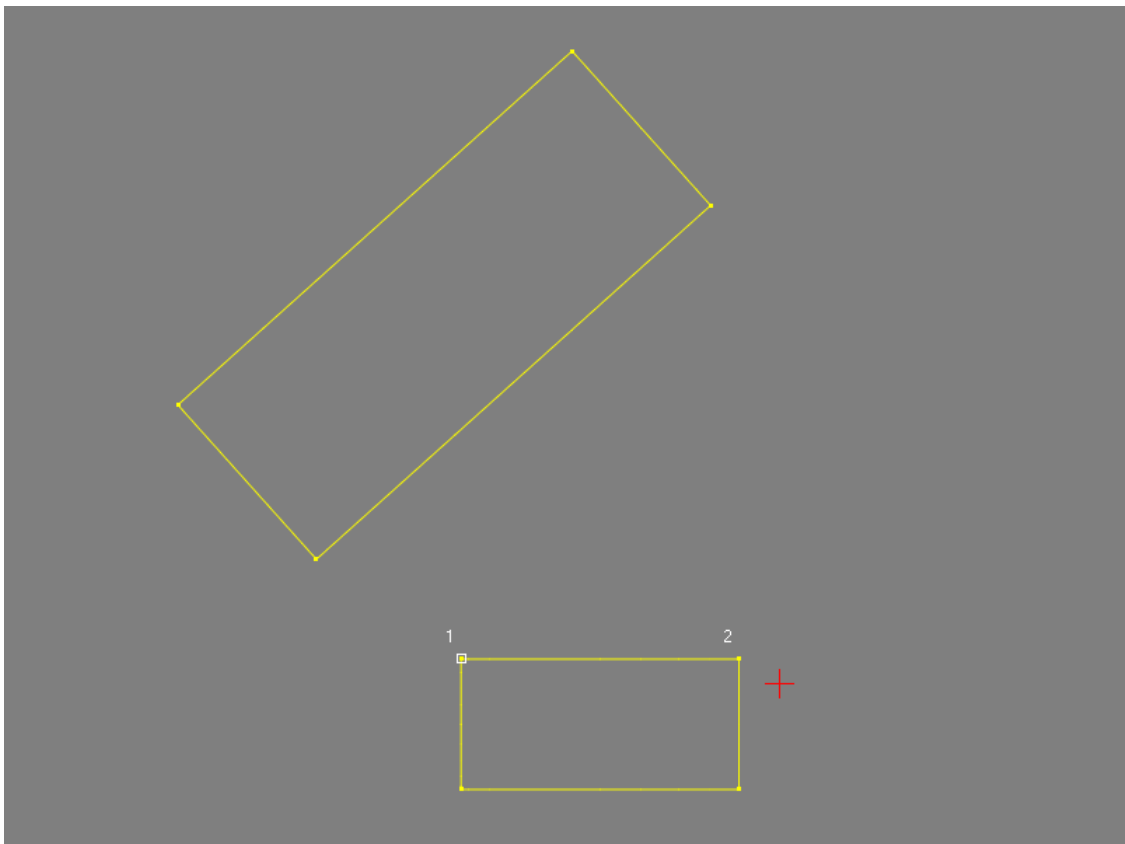

Fig. 160. Selecting vertices of the object chosen for geometric transformation.



The selected vertices need not be always adjacent.



To cancel the selection, press **Esc**.

6. Using the **left mouse button**, select two vertices of the object, relative to which the transformation will be performed. Labels 1' and 2' will appear in the vicinity of the selected vertices.

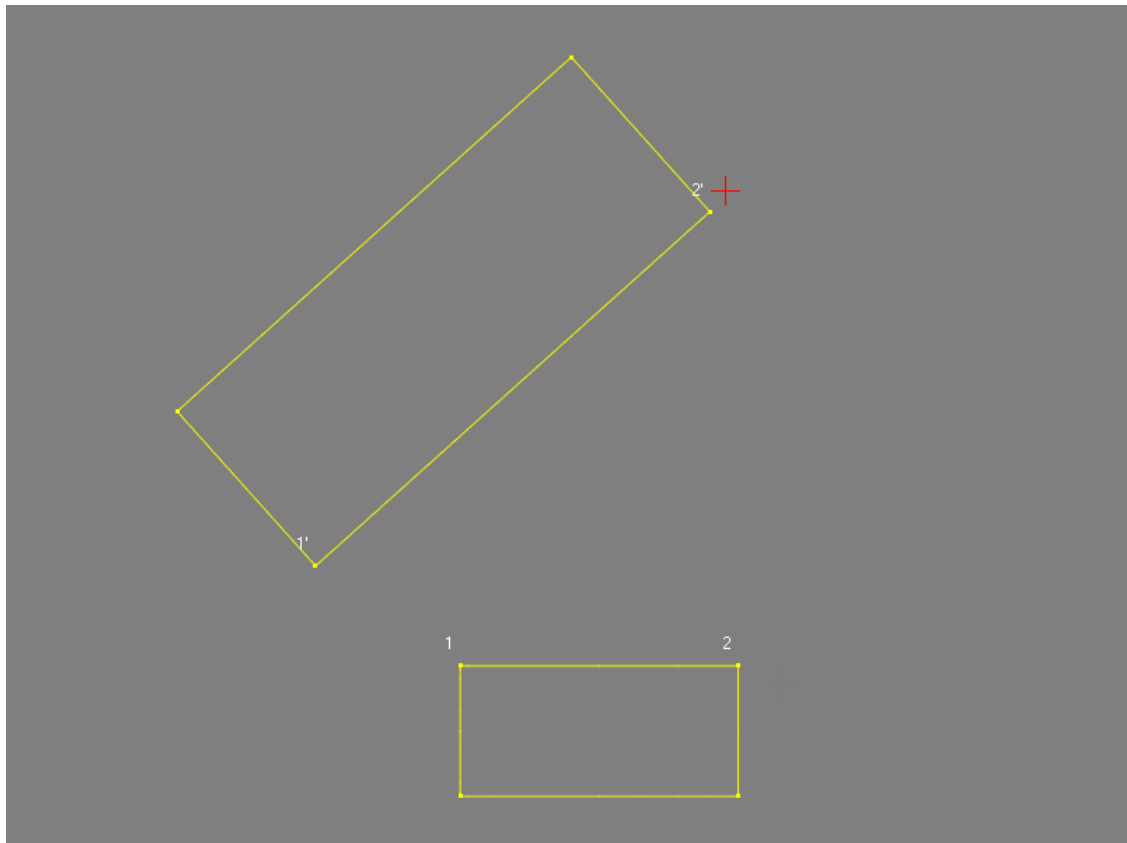

Fig. 161. Selecting vertices of the object, relative to which the transformation will be performed.

7. Press **Enter**.

The vector object, chosen for transformation, is rotated and moved on the plane as follows:

- Vertices 1 and 1' coincide on the plane;
- The vertex 2 is located on the straight line between vertices 1' and 2'.

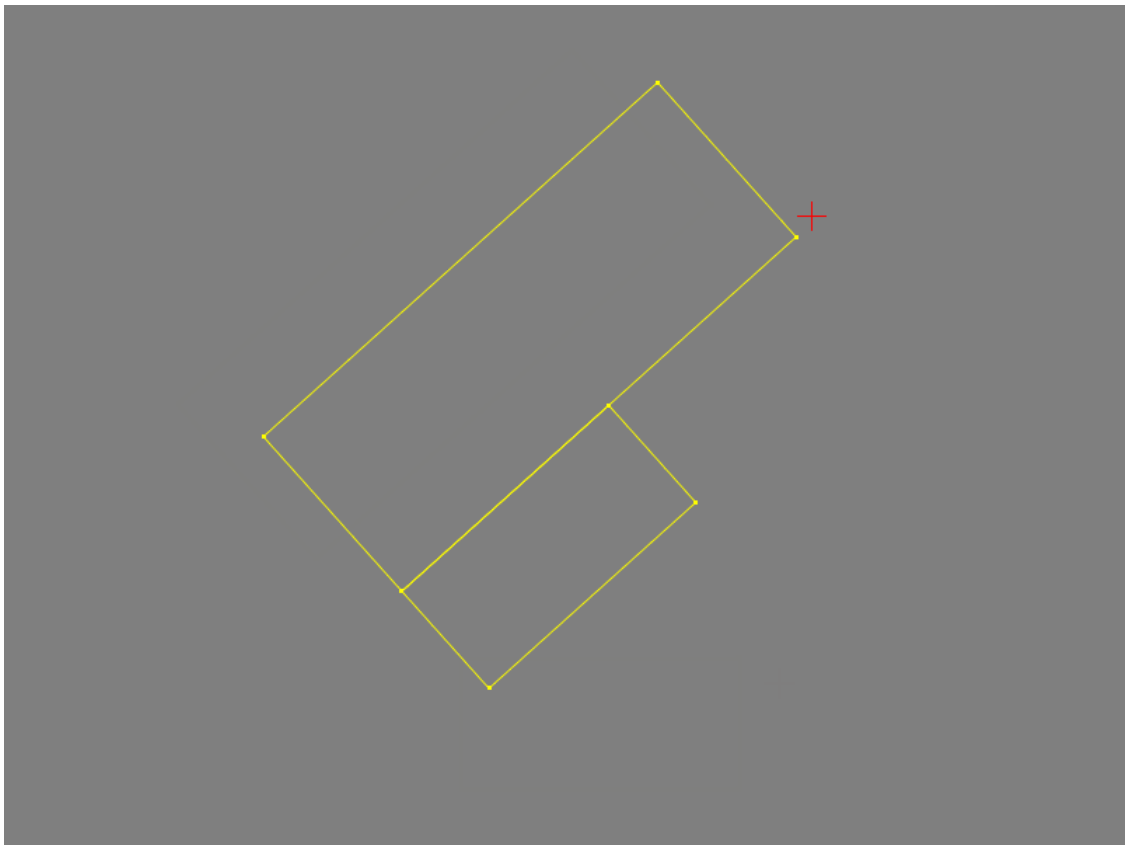

Fig. 162. Connected vector objects.

If the **Scale when align** function was also enabled, the vector object under transformation is scaled after connecting in the way that the length of the segment (distance) between vertices 1 and 2 would be equal to the length of the segment (distance) between vertices 1' and 2'.

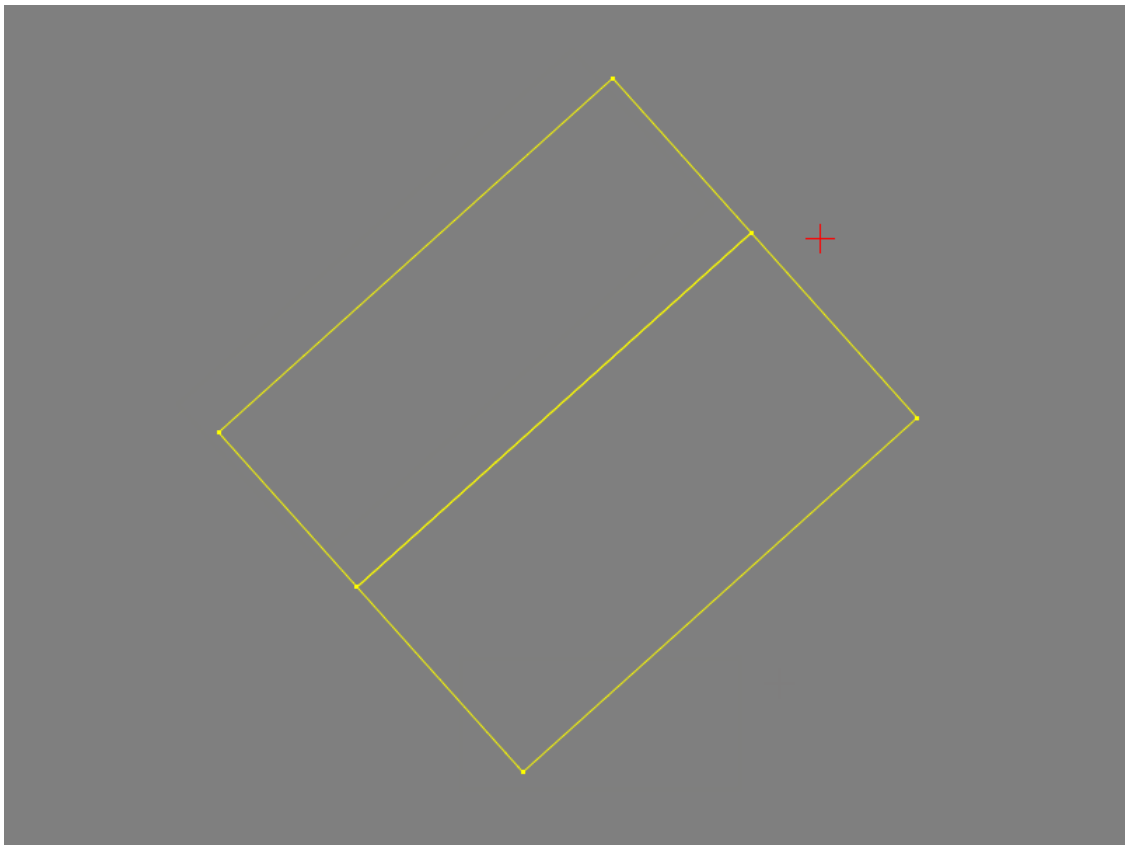

Fig. 163. Connected and scaled vector objects.

If the **Change Z of aligned object** checkbox was set in the **Vectors** tab of the **Settings** window (**Service > Settings > Vectors**), the height of the object under transformation after connection will coincide with the height of the object relative to which the transformation is performed.



The system allows for geometric transformation of several objects at once in alignment mode, for example in case of **roofs**. To do this, **select** several vector objects before choosing vertices.

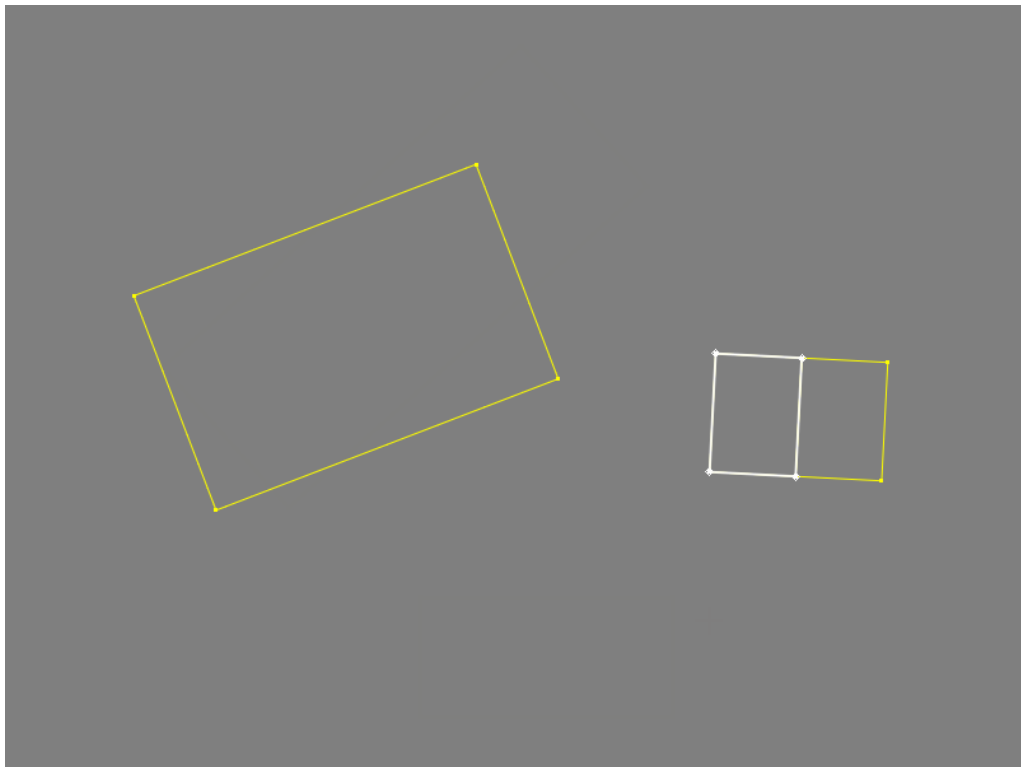

Fig. 164. A gable roof consisting of two vector objects (the left pitch is selected).

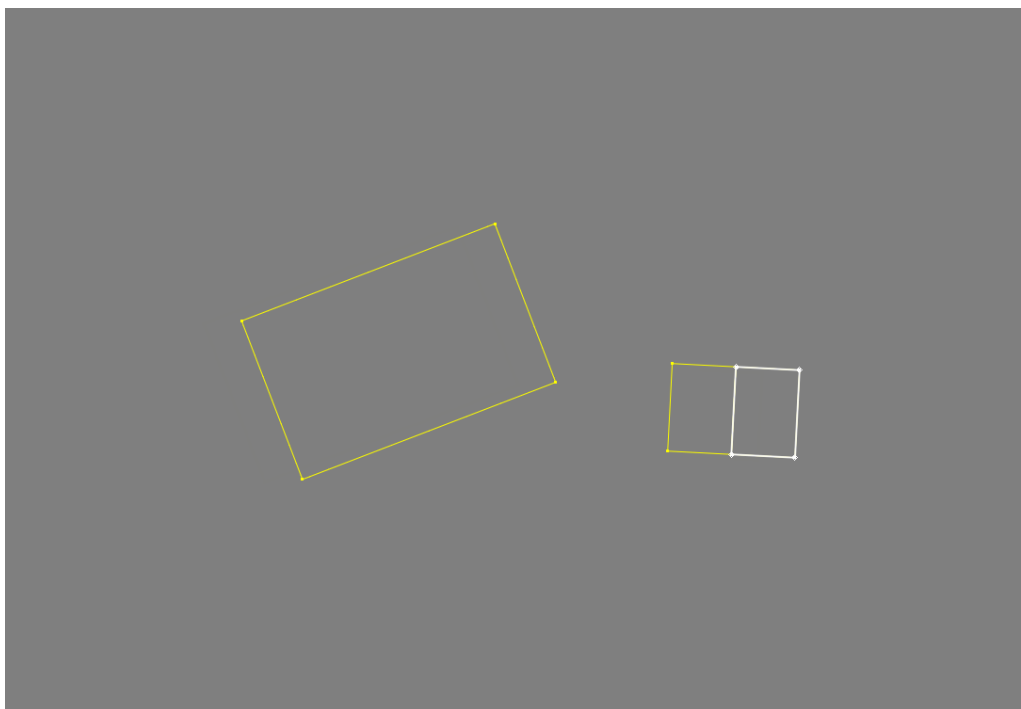

Fig. 165. A gable roof consisting of two vector objects (the right pitch is selected).

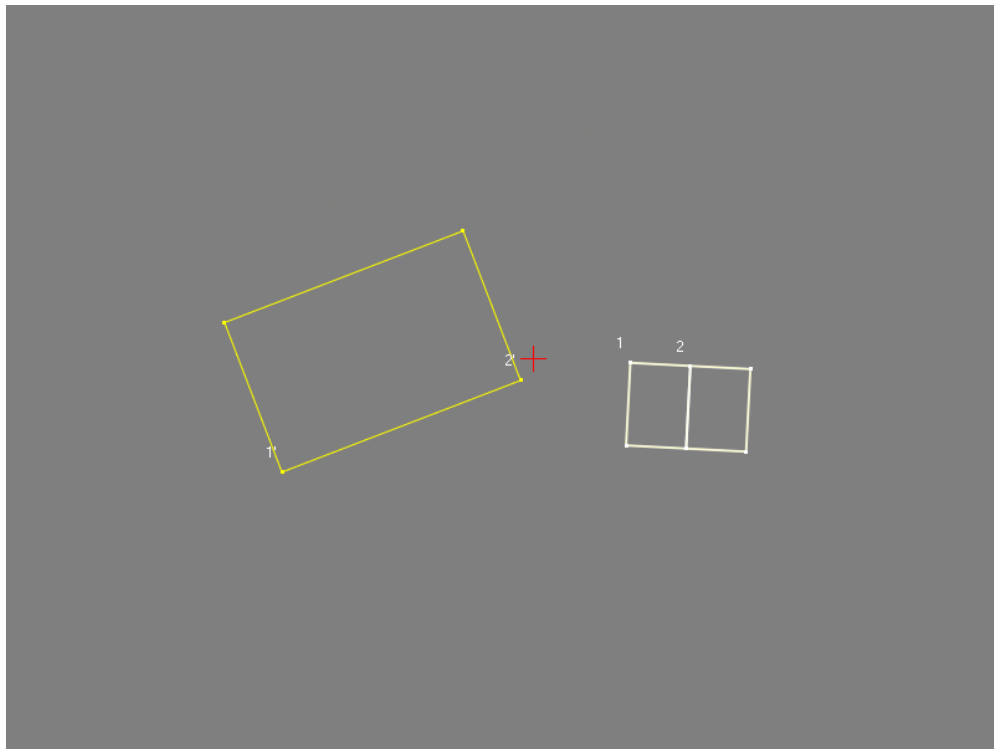

Fig. 166. Geometric transformation of a roof consisting of two polygons, in the alignment mode (Option 1). The scaling mode is enabled.

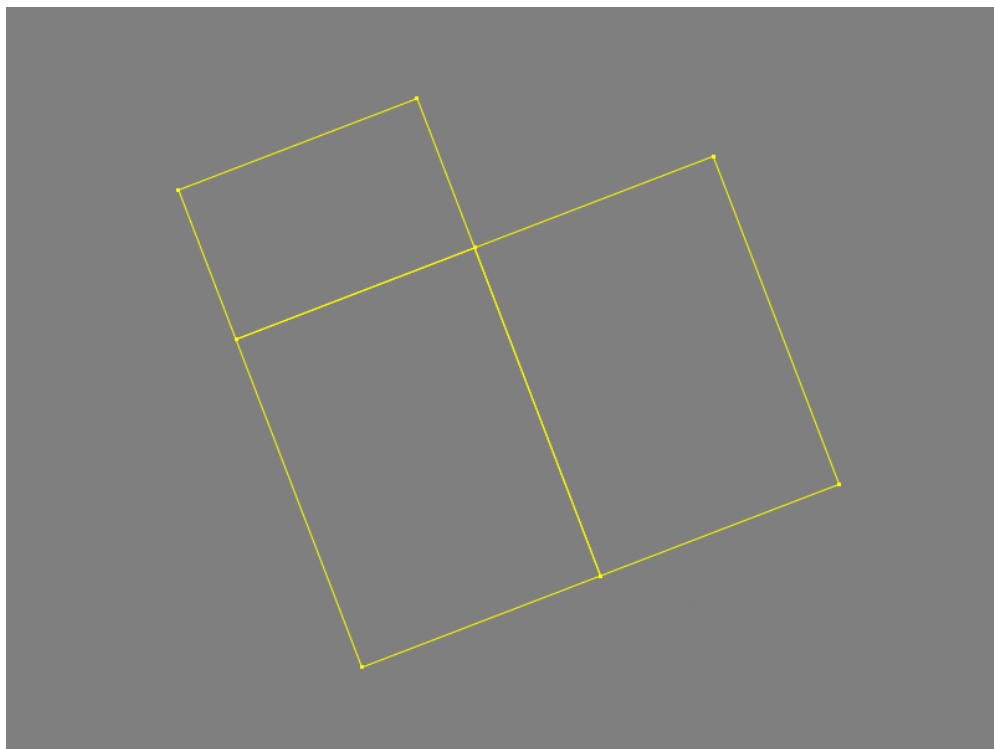

Fig. 167. Geometric transformation of a roof consisting of two polygons, in the alignment mode (Option 1). The scaling mode is enabled.

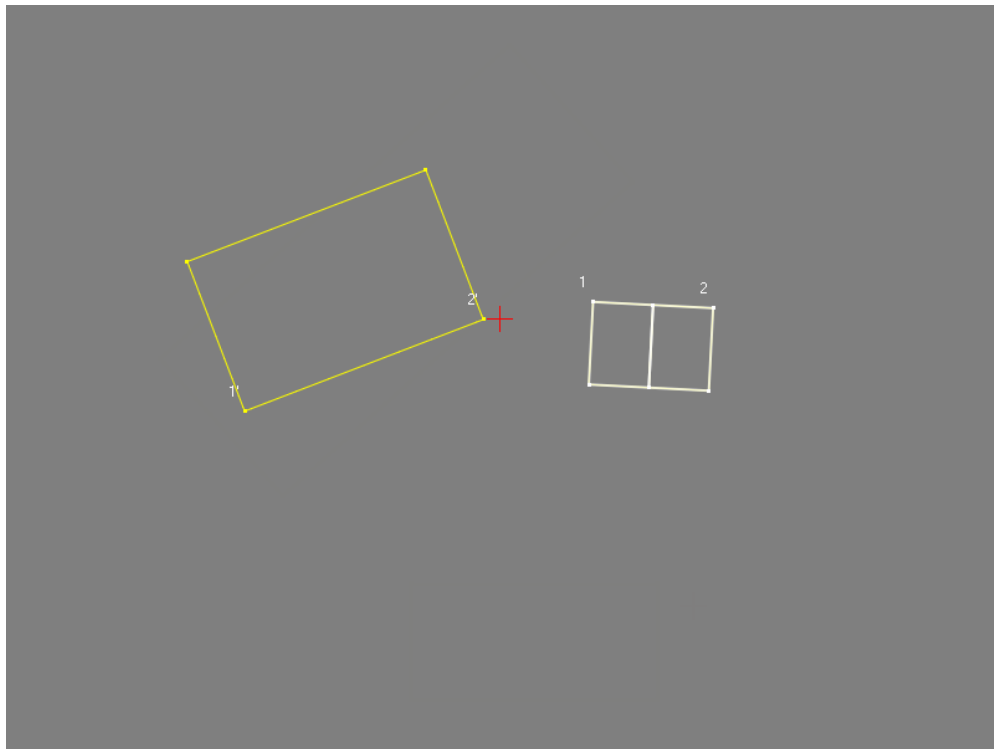

Fig. 168. Geometric transformation of a roof consisting of two polygons, in the alignment mode (Option 2). The scaling mode is enabled.

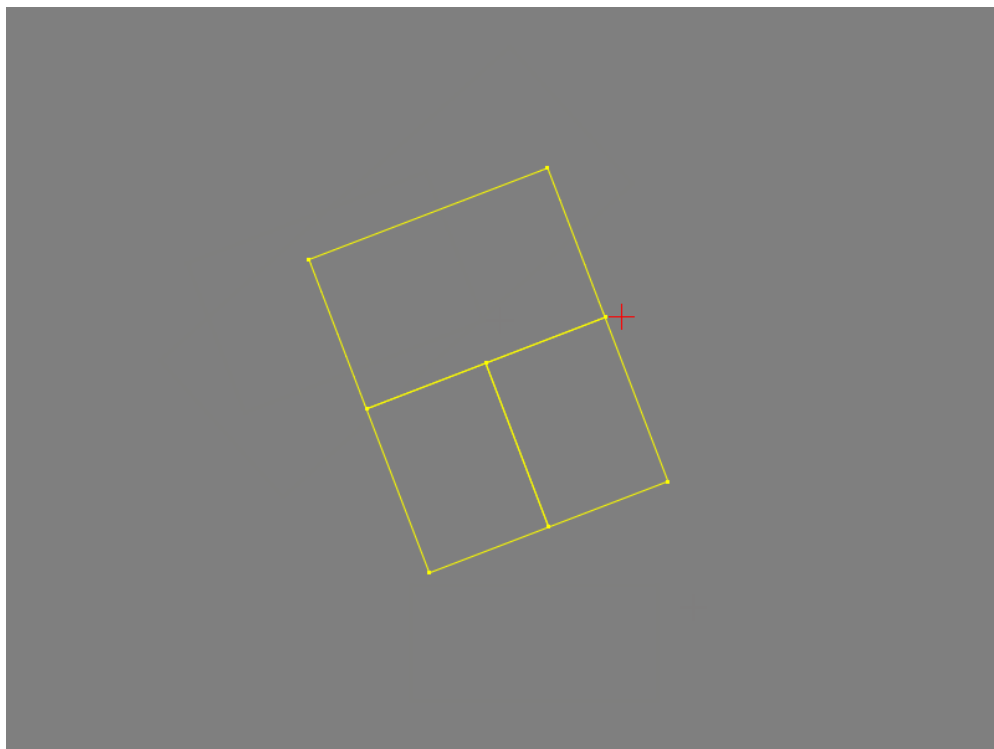

Fig. 169. Geometric transformation of a roof consisting of two polygons, in the alignment mode (Option 2). The scaling mode is enabled.

10.1.11. Projective transform

The system allows to perform projective transformation of vector objects.

Perform the following actions to do this:

1. Select **Vectors > Geometry > Projective transform**. The **Apply projective transform** window opens.

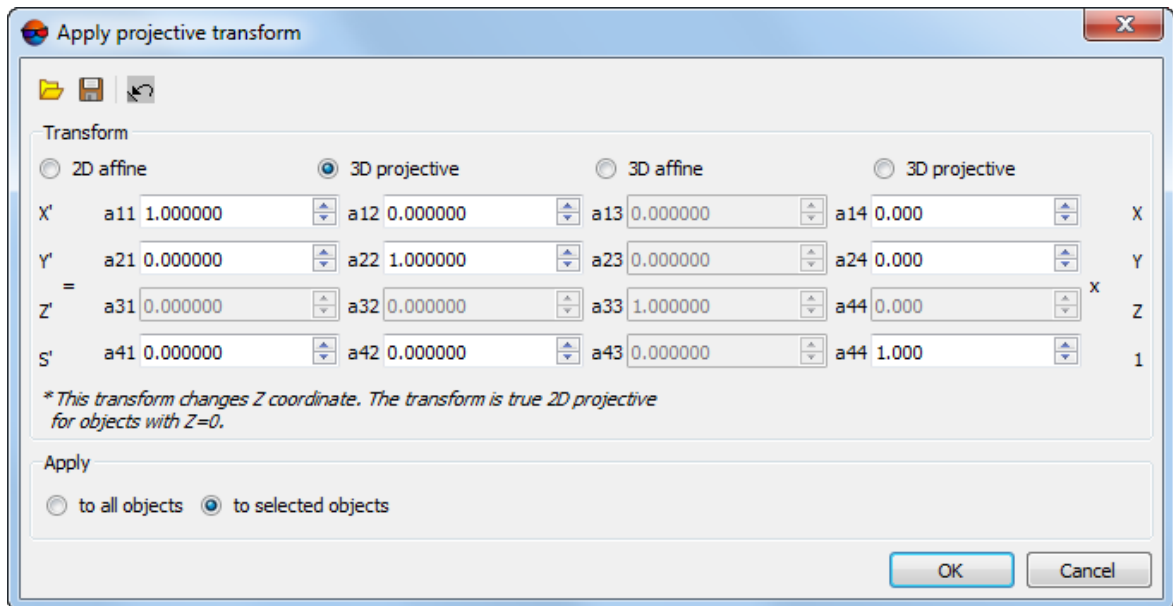



Fig. 170. Parameters of projective transform

2. Select one of the following transformation types:
 - **2D affine** – the system performs transformation by rotation matrix and parallel displacement;
 - **2D projective** – the system performs transformation by rotation matrix, parallel displacement and scaling;
 - ⚠ This type of transformation leads to change Z coordinate!
 - **3D affine** – the system performs transformation by rotation matrix and parallel displacement, including transformation by Z;
 - **3D projective** – the system performs transformation by rotation matrix, parallel displacement and scaling;
3. Specify transformation coefficients depending from selected transformation type.



The  button allows to save coefficients to a CSV-file. The  button allows to load coefficients from a CSV-file.

To reset coefficients to default values click the  button.

- [optional] In the **Apply** section choose objects to transform:
 - **All objects;**
 - **Selected objects.**
- Click OK. After that all or selected vectors of active layer are transformed according to specified parameters.

10.2. Creation of additional vector objects

10.2.1. Adding intersection points

The system provides the ability to automatically add a vertex at the intersection of vector objects. Perform the following actions to do this:

- Select **Vectors** › **Geometry** › **Add intersection points**. The **Layers selection** window opens.

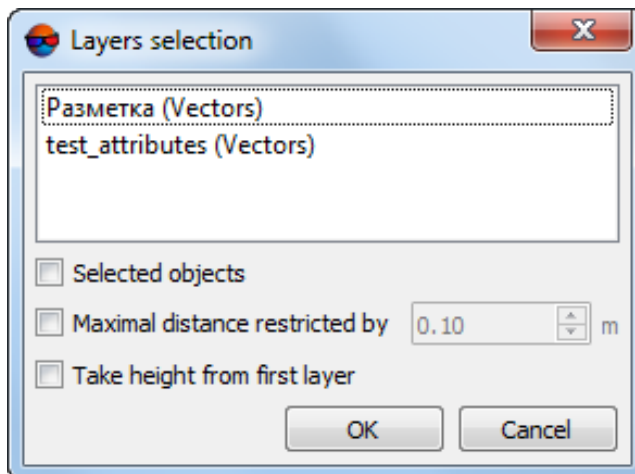

Fig. 171. Parameters of intersection points adding

- Select in the list one or several layers where to search for vector objects intersections.
- [optional] To apply the operation to selected objects only, set the **Selected objects** checkbox on.

4. [optional] To apply the operation only to objects, the distance between which is less than a predetermined value, set the **Maximal distance restricted by** checkbox on and specify distance between the objects.
5. [optional] In order to **take height from first layer** – set the appropriate checkbox;
6. Click OK. After that the system adds points at the intersection of polylines/polygons in accordance with the specified parameters.



Intersection points are added on both intersected objects.

10.2.2. Creating a symmetric objects

The system provides possibility to create symmetrical lengthy objects both linear and areal. The functions of the **Symmetric objects** menu are used to automate creation of conditionally symmetrical objects, such as roads, water bodies, etc.

Perform the following actions for creating a symmetric object (polyline):

1. Create the polyline (draw one side of an extended object, e.g., river bank).
2. Highlight the polyline for symmetrical reflection.
3. Place marker on another side of the object on image (for example, the opposite bank of the river).
4. Choose **Vectors › Geometry › Symmetric objects › Polyline**. As a result, a highlighted polyline is symmetrically copied to the marker position.



A correctness of the function to be performed depends on mutual position of marker and polyline selected.



Fig. 172. Steps for creation of the symmetric polylines

To create quasi-symmetric polygon object, perform the following:

1. Choose **Vectors** › **Geometry** › **Symmetric objects** › **Polygon**;
2. Start to draw a polygon;



A distance between the second parallel line and initial segments of the creating polygon is defined with a distance between the first and the second vertices of given polygon (see figures).



A position of the second parallel line regarding initial segments of the creating polygon (on the left or on the right respectively drawing direction) is defined with an angle between the first and the second segments of given polygon (see figures).

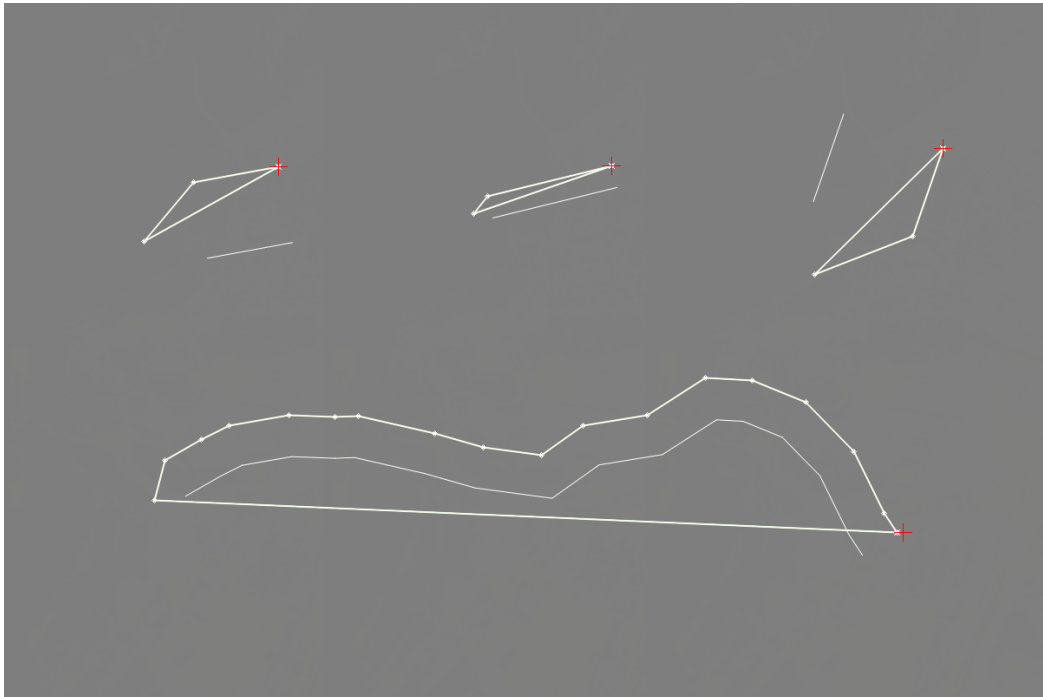

Fig. 173. Initial stage of creating “symmetric” polygon object. Selecting distance between parallel lines and their mutual position

3. Complete polygon creation;

4. Turn off mode **Vectors** › **Geometry** › **Symmetric objects** › **Polygon**.



A correctness of the function to be performed depends on the shape of polygon created.



Given function does not allow to create ring-shaped polygons. To create ring-shaped polygons see “[Cut out area from polygon](#)” chapter.



A split segment of the ring-shaped polygon (see figures) is a segment which is placed between the first and ending vertices of creating polygon. The system allows to create quasi-symmetric ring-shaped polygons with a function as below.

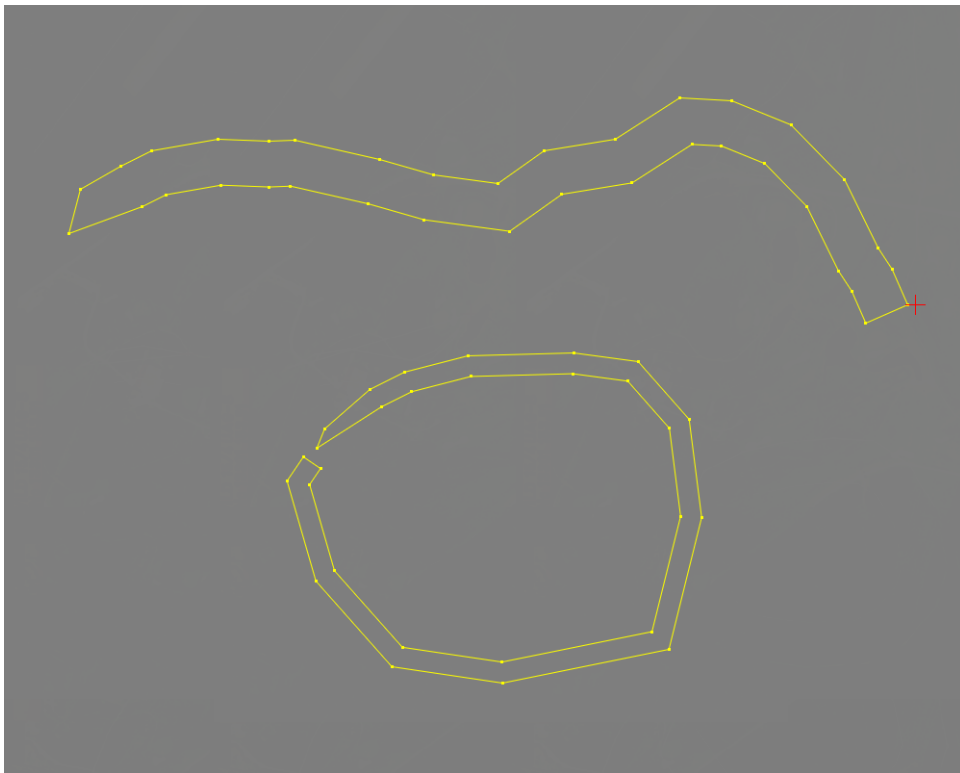

Fig. 174. “Symmetric” polygon objects created with function **Vectors › Geometry › Symmetric objects › Polygon**

To create quasi-symmetric ring-shaped polygon, perform the following:

1. Load or create polygon;
2. Select polygon;
3. Place marker inside or out of polygon;
4. Choose **Vectors › Geometry › Symmetric objects › Polyline**. As a result a quasi-symmetric ring-shaped polygon is created. Its outer or inner boundary (depending on marker position – inside or out of polygon) corresponds to initial polygon boundary.



A correctness of the function to be performed depends on mutual position of the marker and selected polygon.



Given function does not allow to create ring-shaped polygons. To create ring-shaped polygons see “[Cut out area from polygon](#)” chapter.



A split segment of the ring-shaped polygon is a segment which is placed between the first and ending vertices of initial polygon. The system allows to create quasi-symmetric ring-shaped polygons with a function mentioned above as well.

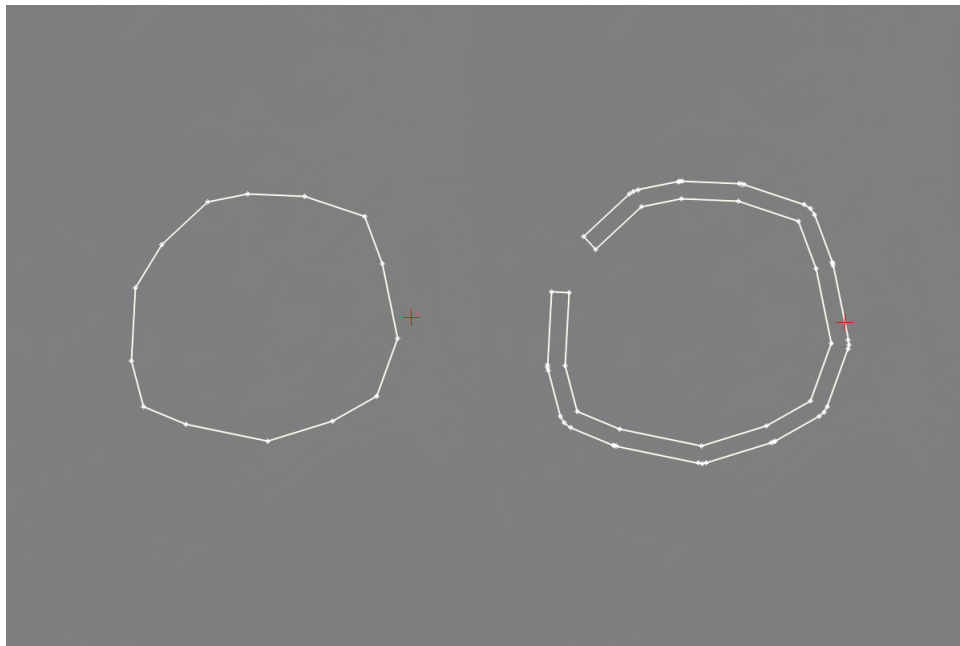

Fig. 175. Creating "symmetric" polygon objects

The system also allows to create mirror symmetry objects based both on polygons and polylines (resulted object is a polygon anyway). To create these objects perform the following:

1. Load or create polyline/polygon;
2. Select given object;
3. Turn on **point editing mode** in **Vectors** toolbar. Turn on **add to selection** mode in **Tools** toolbar.
4. Select any *two* vertices of the object like to set a *symmetry axis* of creating object;
5. Выберите **Vectors** › **Geometry** › **Symmetric objects** › **Mirror object**. As a result selected object will be transformed around specified symmetry axis into polygon object.



Shape of the resulted object depends on symmetry axis specified (i.e. mutual position of two selected vertices).



It is necessary to take into account that a segment placed between the initial and ending vertices of the polygon will be deleted (in some cases while specifying symmetry axis of the creating object it is recommended to select these vertices directly).



Points selected while specifying a symmetry axis are duplicated as well.

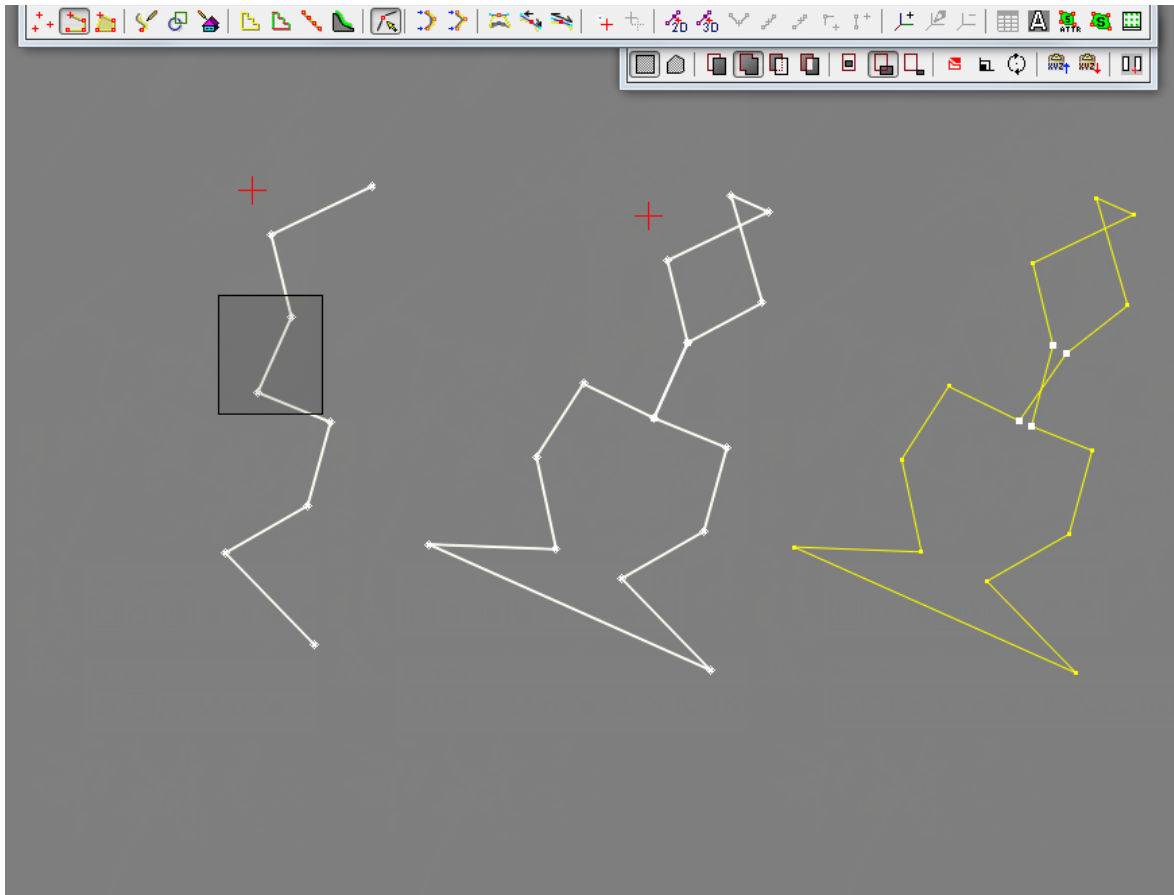

Fig. 176. Creating mirror symmetry polygon objects from polyline

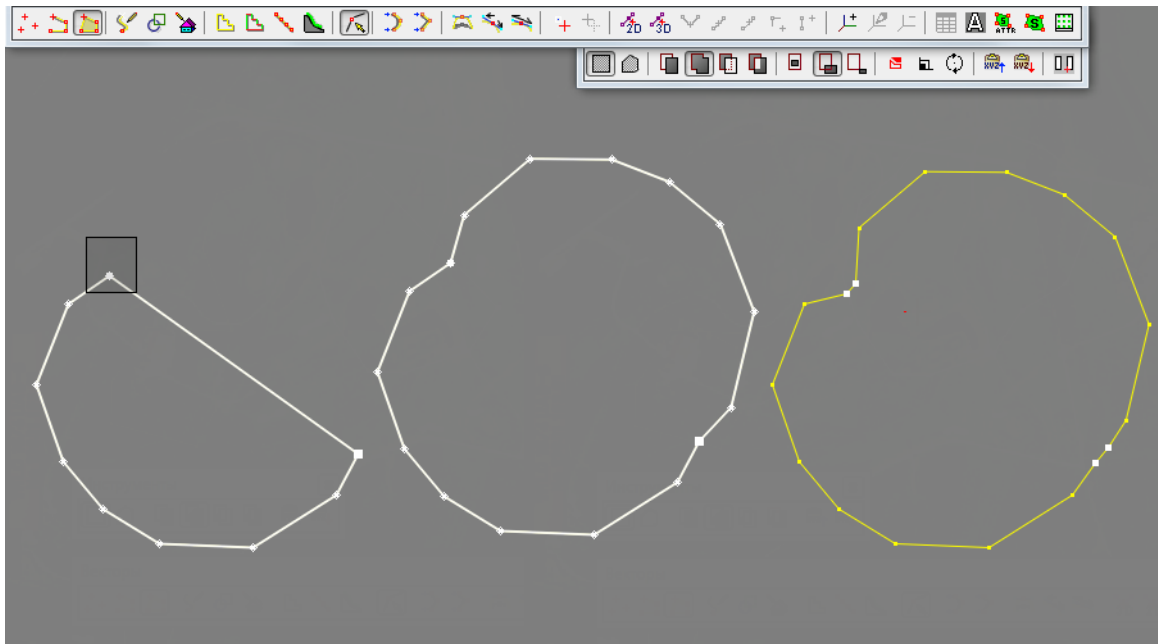

Fig. 177. Creating mirror symmetry polygon objects from polygon

10.2.3. Building buffer zone

Building of the buffer zone means to create a polyline/polygon parallel to selected line and situated at a predetermined distance from it.

To create buffer zone perform the following actions:

1. Select vector objects in 2D-window and choose **Vectors › Geometry › Buffer zone**. After that the window of buffer zone parameters is opened.



Buffer zone could be created both around linear, and areal objects.

If in 2D-window select only one type of objects, automatically set on the **Poly-lines/Polygons**checkbox depending on type of selected objects.

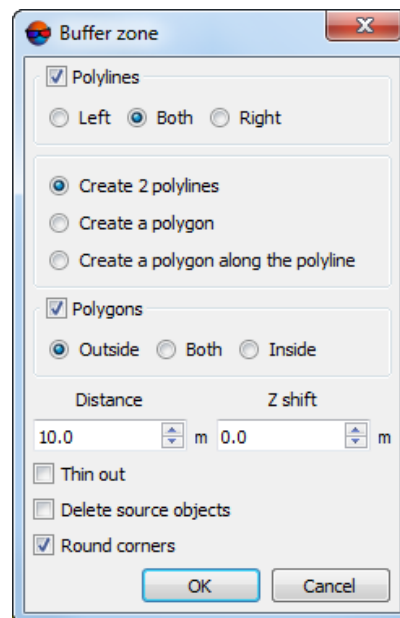

Fig. 178. Window of buffer zone parameters

2. [optional] Buffer zone could be created for objects of only one type, if needed. If selected both polylines and polygons, remove one of checkboxes.
3. Define location of buffer zone in regard to selected object.

For **polyline** the system provides the following ways of buffer zone location:

- **Left** – to the “left” of the active object in accordance with the numbering of its vertices;
- **Right** – to the “right” of the active object in accordance with the numbering of its vertices;

- **Both** – on both sides of the selected object. In this case the system allows:
 - **Create 2 polylines** on both sides of the polyline;
 - **Create a polygon** around polyline;
 - **Create a polygon along the polyline.**

For **Polygon** the system provides the following ways of buffer zone location:

- **Outside** – outside of source polygon;
- **Inside** – inside of source polygon;
- **Both** – on both sides of the selected object.

4. Depend parameters of buffer zone creation:

- **Distance** – a distance from selected object in meters (buffer zone width);
- **Z shift** – shift of buffer zone polyline vertices on specified height;
- **Thin out** – allows to thin out vertices of selected objects during buffer zone creation;
- **Delete source object** – allows to delete source object during buffer zone creation;
- **Round corners** – allows to round the corners of the outer edge of the buffer zone.

5. Click OK to create buffer zone for selected vector objects.

The system provides for quick creation of a buffer zone for the vector objects of the same type (polygon, polyline, or some polylines).



The system provides for quick creation of a buffer zone for a single selected polygon. This restriction does not apply to polylines.

For the fast creation of the buffer zone perform the following actions:

1. Select vector objects in 2D-window;
2. [optional] move the marker in XY plane to set the buffer zone width;
3. [optional] change the marker height to shift of buffer zone polygon/polyline vertices on specified height;
4. Choose **Vectors › Geometry › Buffer zone to marker** to create buffer zone for selected vector objects.



When working with vector objects, for ease **Vectors** > **Geometry** > **Buffer zone to marker** function use it is recommended to set an appropriate hotkey (see the “[General information](#)” User Manual).

10.2.4. Geometric figures around objects vertices

The system allows to create circles with defined radius, rectangles or squares with defined side length around vertices of linear objects.

Perform the following actions to do this:

1. **Select** a vector objects.
2. Choose **Vectors** > **Geometry** > **Objects around points**. The **Settings** window opens.

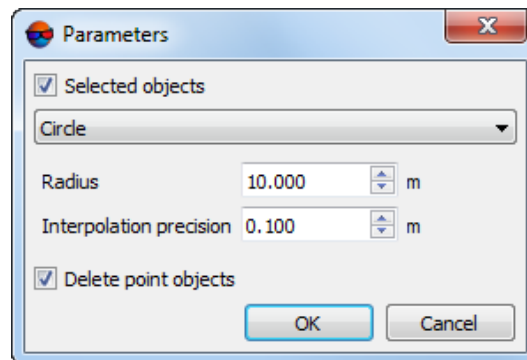

Fig. 179. Parameters of geometric figures creation around objects vertices

3. Specify the following parameters:
 - [optional] **Selected objects** – geometric figures creates only around vertices of *selected* objects, otherwise – around vertices of all objects in current layer;
 - select a geometric figure type: **circle**, **square** or **rectangle**;
 - [optional] **Circle radius** – allows to specify circle radius in meters;
 - [optional] **Interpolation precision** – allows to specify maximal discrepancy between segments of polyline that replaces a circle and the circle itself;
 - [optional] **Height** of square – allows to specify square’s side length;
 - [optional] **Height** and **Width** of rectangle – allows to specify rectangle’s size;
 - [optional] To **delete point objects** when the operation is complete, set an appropriate checkbox.

4. Click OK.

All **attributes** of a point object around which a polygon (geometric figure) is created are automatically assigned to the above polygon. This feature can be useful e.g. for further GCP outline creation (for detail, see the “Splitting into sheets” in the “**Orthophotomaps creation**” User Manual).

10.2.5. Creation of profiles through selected objects

The system provides the function of construction of perpendicular profiles through the group of linear vector objects. The resulting processing profiles (linear or point vector objects) attached to the selected codes in the classifier and are used to solve a variety of applied tasks.



This function is used, for example, to describe a dam “consisting” of two lines on both sides of its base, and two lines on its surface.

Perform the following actions to create profile:

1. **Selects** one object by double-click.
2. Do not unselect object and select the rest objects from the group.
3. Select **Vectors** › **Geometry** › **Vectors profiles**. The **Vectors profiles** window opens.

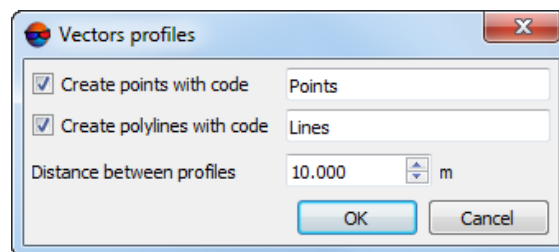

Fig. 180. Generation profile by vectors

4. In the **Distance between profiles** field specify a step of profile lines creation (in meters) to generate profiles approximately perpendicular to the selected vector object.
5. [optional] To save points of profiles intersection with selected objects as points codes, set the **Create points with code** checkbox on and specify the code name.
6. [optional] To save lines of profiles with selected objects as polylines codes, set the **Create polylines with code** checkbox on and specify the code name.



Points and polylines are assigned to classifier as codes of linear (L) and point (P) objects and are placed to the root layer of the classifier table.

- Click OK. After that the system creates perpendicular profiles through selected vector objects.

10.2.6. Checking orthogonality of polygons corners

The system provides possibility to check orthogonality of polygons corners. A search of errors of deviation from the right angle between the vertices of the object or the distance between the leg and then the apex of the object.

In order to find these errors, perform the following actions:

- [optional] To check orthogonality for selected objects, select them on the layer.
- Check **Vectors** > **Geometry** > **Check orthogonality**. The **Check orthogonality** window opens.

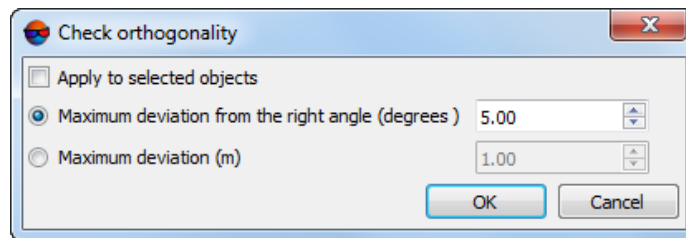

Fig. 181. Checking orthogonality of corners

- [optional] In order to verify orthogonality of only selected objects, set the **Apply to selected** checkbox on.
- Select one of the following ways of moving:
 - **Maximum deviation from the right angle (degrees)** – maximum angle deviation between two sequence vertices, from 90 degrees.



Input maximum value of deviation on degrees.

- **Maximum deviation (m)** – maximum deviation of distance between vertex of triangle leg (that conditionally completed between two sequence vertices) and the next vertex of objects.



The right angle of triangle is between conditional leg vertex and the first vertex, from which is calculates the angle.



Input maximum value of deviation on meters.

5. Click OK. Information message with number of orthogonality errors is displayed. The *Orthogonality* layer creates. It contains vertices of object with deviations.

10.2.7. Extraction of vector objects by spatial relationship

The system provides for creating a new vector layer that contains objects selected from the source vector layer in terms of spatial relationship with objects of the third (additional) layer.

Spatial relationship indicates how a certain object is located in space, relative to another (reference) object. This feature is available for all types of vector objects, both for point ones and for polylines (polygons).

The following criteria of object selection in terms of spatial relationship are provided:

- **intersect** – a vector object located in the source layer intersects a vector object located in the additional layer;



Intersection of vector objects in the 3D space is obligatory (see the “Process in 3D-window” section in the “[General information](#)” User Manual). For example, polygons whose planes do not intersect in the 3D space are not considered intersecting, despite their possible visual intersection in a 2D window.

Similarly, the location of a point object on the plane of the polygon (inside it) is a sufficient condition for the intersection of the polygon and the point object, even if there are no intersections of the point with the segments of the polygon. At the same time, visual crossing of a point with a polygon segment in the 2D window (without exact spatial coincidence in elevation) is not a sufficient condition (see the detailed description of 2D and 3D snapping tools in [Section 3.4.6](#)).

- **touch** – a linear vector object located in the source layer that has at least one common segment with a linear vector object located in the additional layer;



Exact spatial coincidence of vector objects’ elements in the 3D space is obligatory (see the detailed description of 2D and 3D snapping tools in [Section 3.4.6](#)). The segment match must be complete (i.e., it implies an exact geometric match of initial and final vertices of both segments). A point object is tangent to a polygon (polyline) if it is located in any part of this object segment (Z-coordinate is taken into account).

- **contain** – a vector object of the additional layer is located entirely inside a vector object in the source layer;



Both objects must be located in the same plane (see the “Process in 3D-window” section in the “[General information](#)” User Manual).

- **equal** – a vector object in the source layer completely coincides with the vector object of the additional layer;



Complete coincidence of coordinates of objects' vertices (XYZ) and complete coincidence of the order of the location of the objects' vertices are obligatory (see the "Settings of point numbers display" chapter in the "General system's parameters" User Manual).

To extract vector objects according to their spatial relationship, perform the following:

1. Create at least two layers with vector objects;
2. [optional] if only a part of the existing vector objects are to be processed, perform the following:
 - [optional] select the appropriate vector objects in the layer that taken as source;
 - [optional] select the appropriate vector objects in the layer that taken as additional.
3. Choose **Vectors** > **Geometry** > **Extract vectors by spatial relationship**. The **Extract by location** window opens.

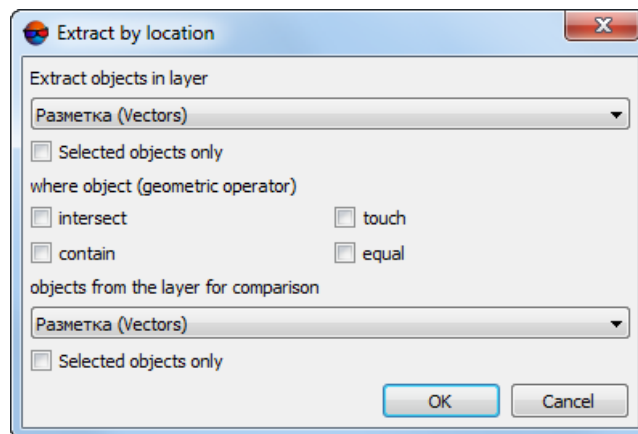

Fig. 182. Object extraction parameters

4. In the **Extract objects in layer** drop-down list, specify the vector layer selected as source;
 - [optional] to process the **selected objects only** in this layer, set the appropriate checkbox;
5. Set the required criteria of object selection (see above) by setting (clearing) the appropriate checkboxes: **intersect**, **touch**, **contain**, **equal**;
6. In the **objects from the layer for comparison** drop-down list, specify the vector layer selected as the additional one;
 - [optional] to process the **selected objects only** in this layer, set the appropriate checkbox;

7. Click OK. After the operation is completed, an appropriate info message is issued, with data on the number of extracted objects;

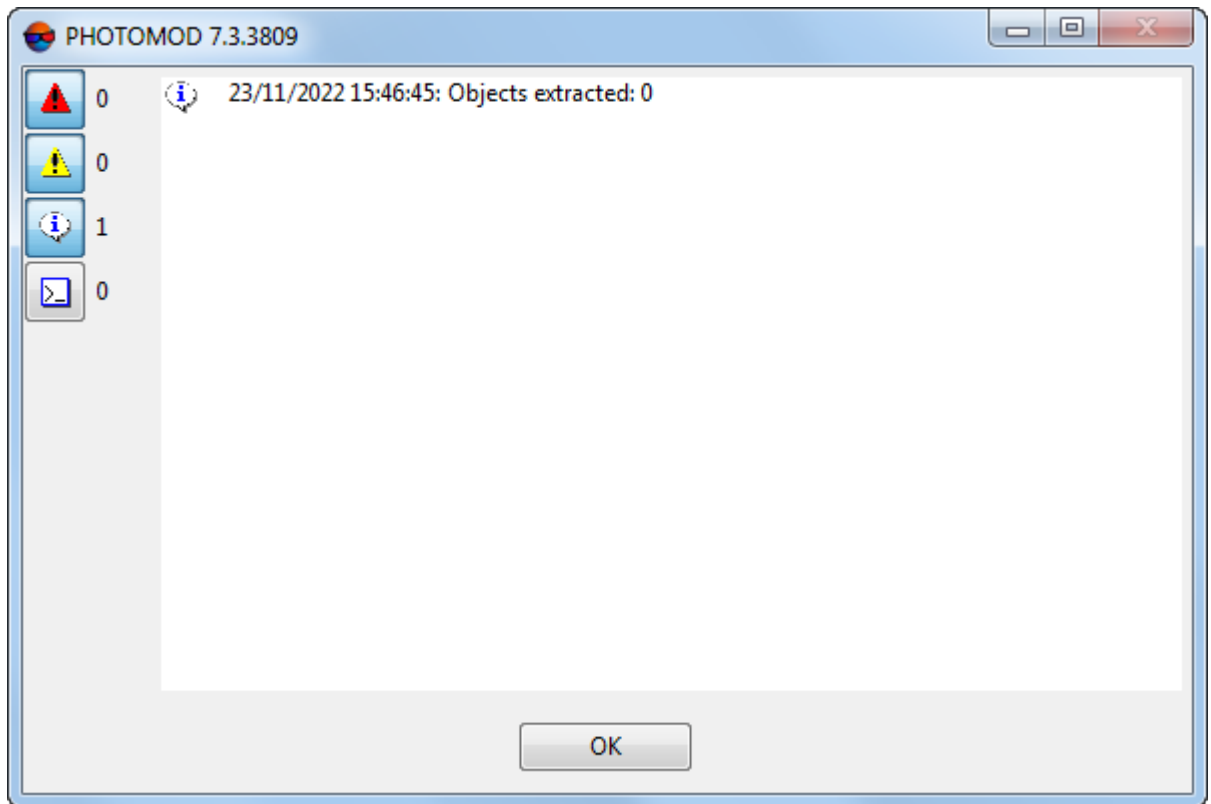

Fig. 183. An info message

8. If objects are found that meet the specified conditions, a new vector layer is created containing suitable objects copied from the source layer.

10.3. Vector objects projecting

10.3.1. Projecting onto relief

The system provides possibility to project vector objects on relief of active stereopair.

Perform the following actions to do this:

1. Open a stereopair and **load** a layer with vector objects.
2. Select **Vectors > Geometry > Project on stereomodel**. The **Parameters** window opens.

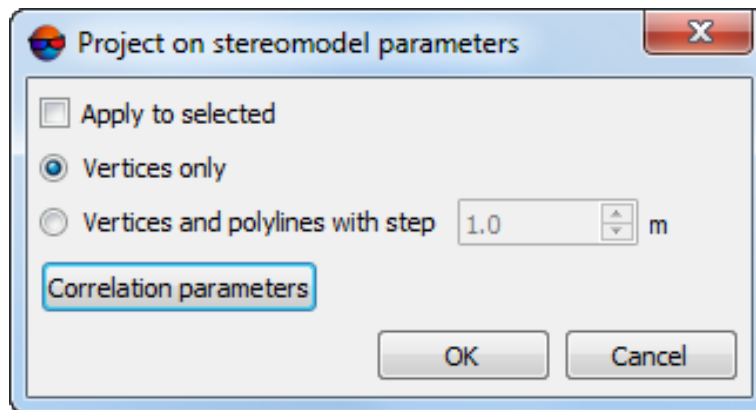

Fig. 184. Parameters of vectors projecting on relief

3. Define the following parameters:
 - **Apply to selected** – allows to project only selected vector objects;
 - **Vertices only** – allows to project only points or vertices of all/selected vector objects;
 - **Vertices and polylines with step** – allows to simultaneously break the linear objects into broken lines fragments at a predetermined step and project intermediate vertices.
4. [optional] To configure correlator's parameters click the **Correlation parameters** button (see the "[General system's parameters](#)" User Manual).
5. Click OK. All or selected vector objects are projected on relief of active stereopair.

10.3.2. Vectors projecting on a TIN

The system allows to project vector objects on TIN.

Perform the following actions to do this:

1. [Load](#) vector layer.
2. Load TIN layer, on which it is necessary to project vectors.
3. Select **Vectors** › **Geometry** › **Project on TIN**. The **Settings** window opens.

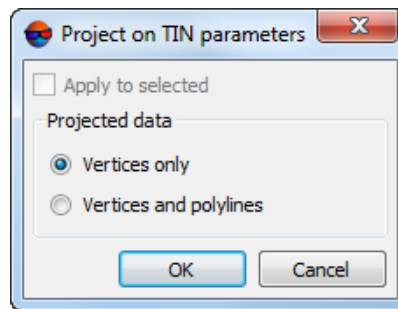

Fig. 185. Parameters of vectors projecting on a TIN

4. Select one the projecting modes:
 - **Vertices only** – only linear objects vertices and points are projected on a TIN;
 - **Vertices and lines** – simultaneously with vertices projection the system performs intersection linear objects by TIN edges and intermediate vertices projecting.
5. [optional] To apply the operation to selected objects only, set the **Apply to selected** checkbox on.
6. Click OK. After that vector objects elevations are replaced by elevations taken from TIN.

10.3.3. Vectors projecting on a DEM

The system allows to project vector objects on DEM (automatically assign elevations (Z) to points/vertices of vector objects from loaded DEM). Perform the following actions to do this:

1. [Load](#) or create vector layer;
2. Load DEM, on which it is necessary to project vector objects;
3. Select **Vectors** › **Geometry** › **Project on DEM**. The **Project objects on DEM** window opens:

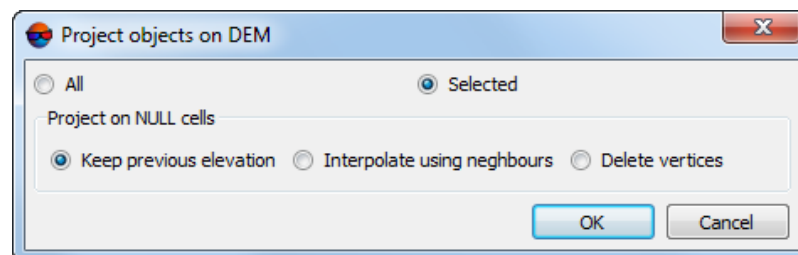

Fig. 186. Parameters of vectors projecting on a DEM

4. [optional] Choose **Selected**, to move selected objects only, otherwise, select **All**.
5. In **Project on NULL cells** section select one of following options:
 - **Keep previous elevation** of vector object vertices;
 - **Interpolate using neighbours** (use DEM cells neighboring to null cells);
 - **Delete vertices** “falling” in null cells;
6. Click OK. After that vector objects elevations are replaced by Z coordinate taken from DEM.

10.4. Deleting point objects using a parameter

10.4.1. Delete points around linear objects

Automatic deleting points around linear objects allows to “filter” points used to the TIN creation. It is used if points, located near to linear objects, are conflict with these linear objects.

In order to delete points perform the following actions:

1. Select **Vectors** > **Geometry** > **Delete points around polylines**. The **Delete points around polylines** window opens.

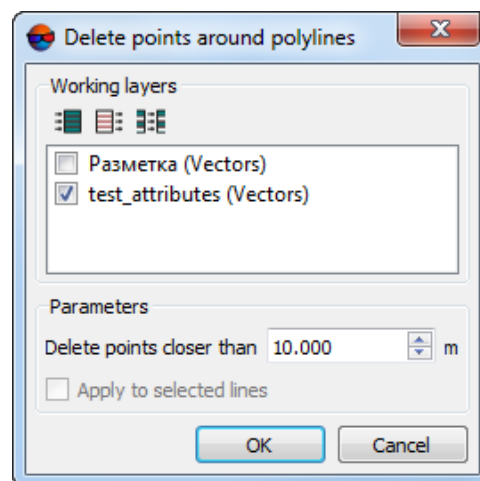

Fig. 187. Parameters of deleting points around linear objects

2. Select **Working layers**. By default the following layer are available:
 - if the TIN layer is active – base vector layers;
 - vector layer, if it is active;

- all vector layers in all other cases.
3. In the **Delete points closer than** field define maximal distance from linear object to a point in meters.
 4. [optional] Set the **Apply to selected lines** checkbox on, to delete points only around selected lines, otherwise – around all.
 5. Click OK. Processing is performed on all selected layers together, that is, for each linear object of each layer are removed point objects that are closer specified distance.

10.4.2. Deleting points inside polygons

The system provides possibility to deleting points inside polygons. Points and polygons could be located both in one layer and different.

In order to delete points inside polygons perform the following actions:

1. [Load](#) a vector layer with points.
2. [optional] If points and polygons are located in different layers, load a layer with polygons.
3. Choose **Vectors > Geometry > Delete points inside polygons**.

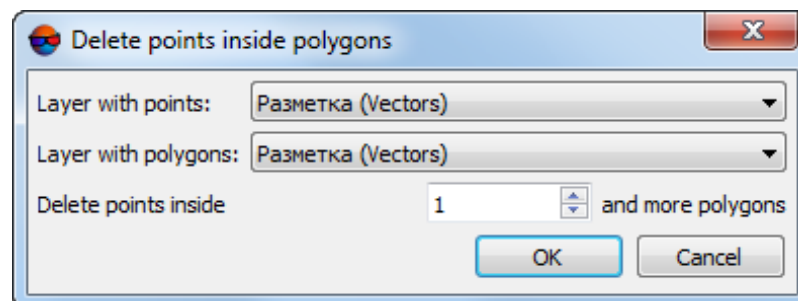

Fig. 188. Parameters of deleting points inside polygons

4. Select layer with points and layer with polygons in appropriate fields.
5. Specify minimal amount of polygons in the **Delete points inside .. and more polygons** field.
6. Click OK. After that all points located inside specified number of polygons will be deleted.

10.5. Transformation of objects coordinates

10.5.1. Swap of X and Y coordinates

The system allows to swap X and Y coordinates of vector objects. This function is used, for example, to correct wrongly specified coordinates during [objects import](#) and allows to re-calculate the coordinates from the left-handed coordinate system to the right-handed one and vice versa.

The **Vectors** > **Geometry** > **Swap X <-> Y** menu item is used for this. At that the coordinate system of project do not change.

10.5.2. Change objects coordinate system

The system provides opportunity of coordinates recalculation from one coordinate system to another for all vertices of current layer.

Perform the following actions to do this:

1. Select **Vectors** > **Geometry** > **Convert coordinate system**. The **Convert coordinate system** window opens.

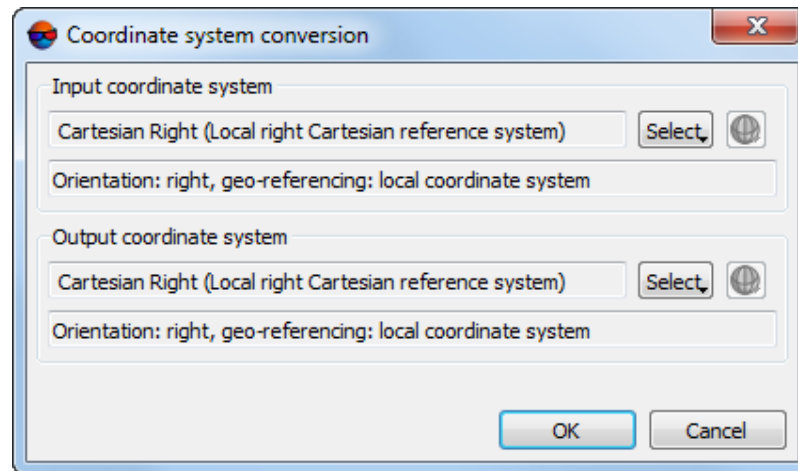

Fig. 189. The Convert coordinate system window

2. Click the **Select** button to specify initial coordinate system.

Coordinate system is specified using one of the following ways:

- **From DB** – from international or Russian coordinate system database (see “Coordinate systems databases” in the “[Creating project](#)” User Manual);
- **From file** – allows to select coordinate system from *.x-ref-system files, located *out* of active profile resources;

- **From resource** – from files with *.x-ref-system extension, located in active profile resources, for example, to select coordinate system from another project of active profile.
- **From GeoCalculator** – from the list of *GeoCalculator* program database (see the “Coordinate Systems” chapter in “[The GeoCalculator program](#)” User manual).



The *GeoCalculator* program allows to edit coordinate systems, to create new ones, to perform import and export of coordinate systems (see the “[The GeoCalculator program](#)” User Manual).



The system also allows to select coordinate system from a list of recently used coordinate systems.

3. [optional] When choosing coordinate system from database the **Coordinate system database** opens, which contains the list of coordinate systems. To perform fast search for coordinate system in the list, input the whole coordinate system name or its part to the **Find** input field.

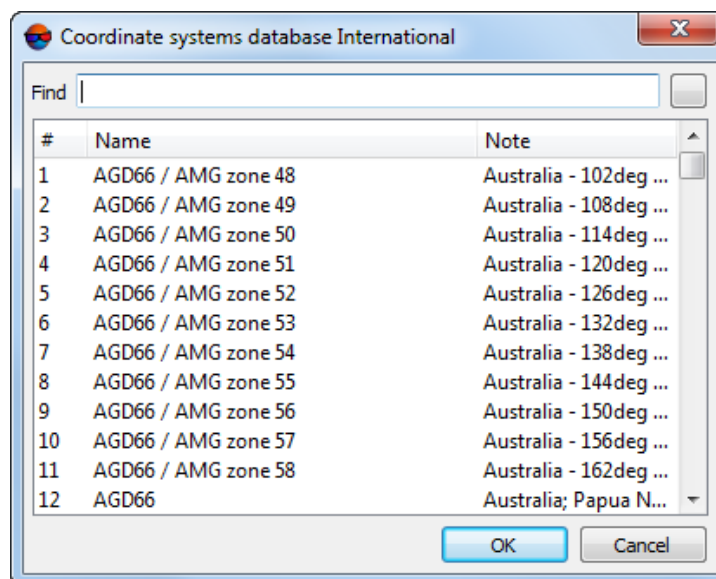

Fig. 190. Coordinate systems database window

4. [optional] To choose geoid, click the  button. Select proper type of geoid usage:

- **No geoid;**
- **EGM 96.**



The system allows to use the EGM2008 geoid. See installation instruction in the User Manual. After installation the geoid is displayed in the list.

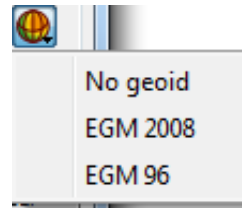

Output coordinate system is specified in the same way.



When working with the project by default as input and output coordinate system is used the project coordinate system. When working without project both coordinate systems should be specified by user.

10.6. Transformation of CSV file

The system allows to delete from CSV-file points out of defined boundaries. The **Cut CSV file** function is used for this with one of parameters:

- by rectangle edge;
- by selected polygons.

In order to cut CSV file by rectangle edges perform the following actions:

1. Choose **Vectors** > **Geometry** > **Cut CSV file by rectangle edges**. The **Settings** window opens.

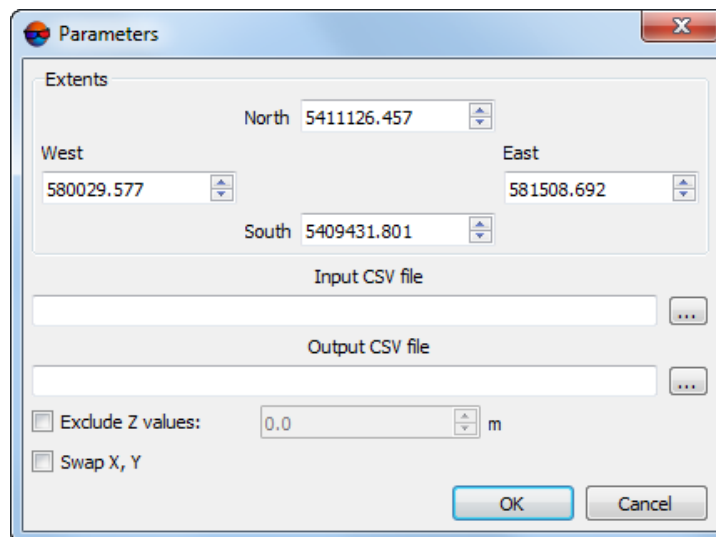



Fig. 191. Parameters of CSV file cutting by rectangle boundaries

2. Enter coordinates of rectangular area in project coordinate system into the **North**, **West**, **East** and **South** fields correspondingly.

3. In the **Output file** section click the  button, to select input CSV-file with *.csv or *.txt extension.
4. In the **Output CSV file** field specify output file name and path to save CSV-file.
5. [optional] In order not to consider points with specified elevation from CSV-file, set the **Exclude Z values** checkbox on and specify Z value in meters.
6. [optional] To swap X and Y coordinates in CSV-file, set the **Swap X Y** checkbox.
7. Click OK. After that the system creates CSV-file, containing information only about vector objects in frames of specified boundaries.

In order to cut CSV file by selected polygons perform the following actions:

1. To specify borders to cut CSV-file, [select](#) polygons.
2. Select **Vectors** > **Geometry** > **Cut CSV file by selected polygons**. The **Settings** window opens.

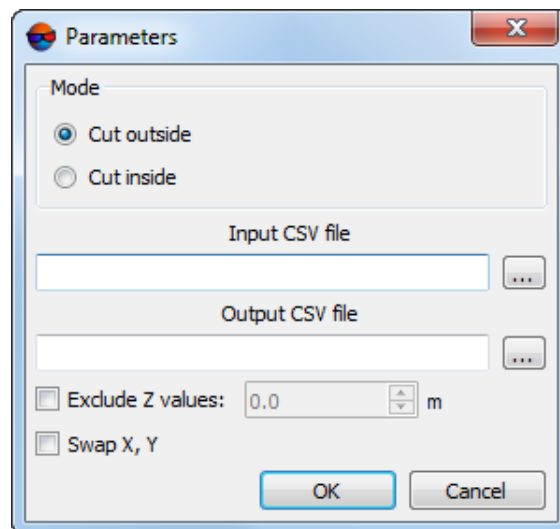



Fig. 192. Parameters of CSV file cutting by selected polygons

3. Choose the file **cutting** mode:
 - **Cut outside** – from CSV-file is deleting points located out of selected polygons;
 - **Cut inside** – from CSV-file is deleting points located inside of selected polygons;
4. In the **Output file** section click the  button, to select input CSV-file with *.csv or *.txt extension.
5. In the **Output CSV file** field specify output file name and path to save CSV-file.

6. [optional] In order not to consider points with specified elevation from CSV-file, set the **Exclude Z values** checkbox on and specify Z value in meters.
7. [optional] To swap X and Y coordinates in CSV-file, set the **Swap X Y** checkbox.
8. Click OK. After that the system creates CSV-file, containing information only about vector objects in frames of specified boundaries.

10.7. Elevation profile of a linear object

The system allows to create an elevation profile of a linear object (in the form of chart, whose vertices are the vertices of a polyline). To create an elevation profile select **one** linear object and choose **Vectors > Geometry > Elevation Profile**.

A window displaying elevation profile of the selected object opens. Z axis shows polyline's vertices elevations, and L axis shows horizontal distances between polyline vertices. On the right hand side of the **Elevation profile** window there is the slider, used to change profile scale by Z axis (the lower limit of the scroll bar is the chart minimum by Z axis).

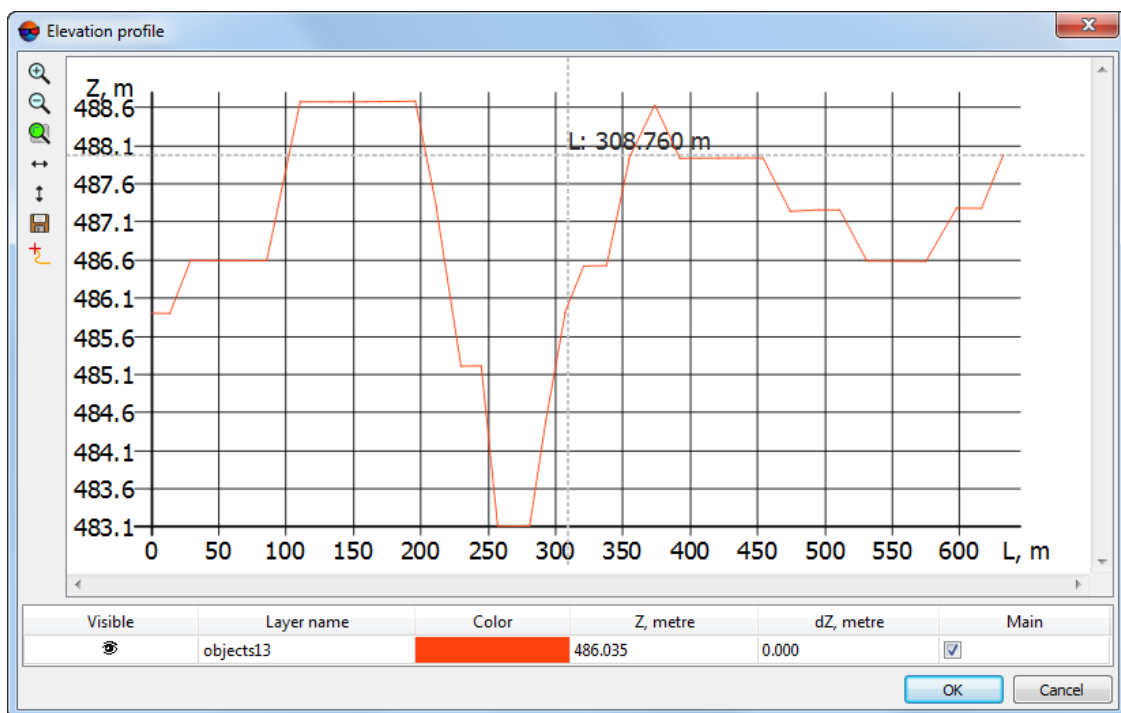



Fig. 193. Elevation profile window

Table 14. Functions provided by the Elevation profile window

Menu items	Functions
Zoom in	to zoom in by Z axis
Zoom out	to zoom out by Z axis

Menu items	Functions
 1:1 scale	to set 1:1 scale

10.8. TIN area info

The system provides possibility to calculate polygon surface area, taking into account vertices height.



The area measurement is available only for the polygons without self-intersections.

To calculate polygons surface area select **Vectors** > **Geometry** > **Surface area of polygons**. After that the system opens information window with the following data (for each polygon on the loaded vector layers):

- information about value of polygon surface area, taking into account vertices height;
- information about value of area of polygon projection on a plane.

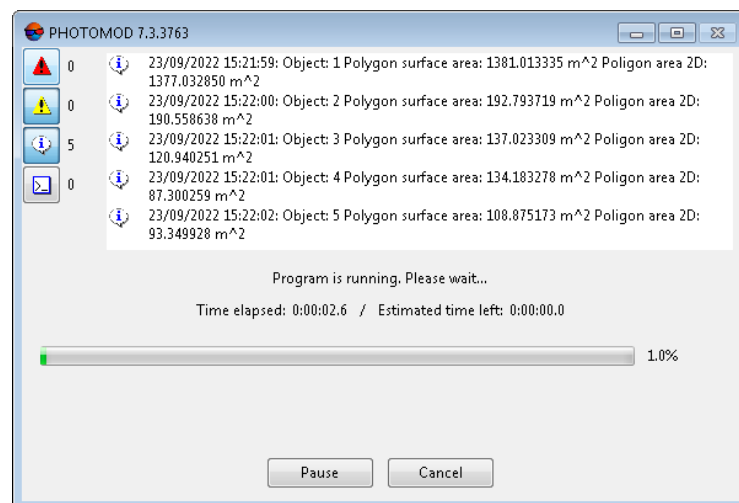

Fig. 194. The area of a polygon on TIN surface

11. Topological operations

11.1. About topology

The *topology* concept is one of the key terms used during quality assessment of created maps. Throughout this documentation, the *topology* is referred to as set of functions and operations, that define mutual location of vector objects and are used to create topologically correct vector data. The system provides the possibility of eliminating typical topological errors, such as:

- self-intersection of polylines/polygons;

- intersections of polylines/polygons without the formation of a common node (vertex at the intersection point);
- polygons overlapping;
- gaps or voids between polygons when a map is covered by polygons, such as woodlands polygons.













Topology – a branch of mathematics that studies the phenomenon of continuity in the most general form, in particular, the properties of space, which remain unchanged under continuous deformations, for example, the connectivity.







11.2. The “Topology” menu

For quick access to functions of vector objects editing, and also to change topological modes the system provides the **Topology** additional toolbar, which buttons partly duplicated in the **Topology** menu.

In order to show the **Topology**, toolbar, choose **Window > Toolbars > Topology**.

Table 15. Brief description of the Topology menu

Menu items	Function
 Topological connectivity mode	to automatically set the objects vertices connected for objects created on a vector layer (see Section 11.3.1)
 Joint points editing mode	to automatically set the objects vertices (located closer than a specified distance) connecting during to a vector object (see Section 11.3.2)
 Close selected polylines (Shift+C)	to convert polyline to polygon (close polyline, see Section 11.4.1)
 Unclose selected polygons (Shift+B)	to convert polygon to polyline (enclose polyline, see Section 11.4.2)
 Merge two polylines (Shift+P)	to merge selected polylines into a single one by adding a segment between two last vertices of merging polylines (see Section 11.4.3)
 Merge polygons (Shift+G)	to merge selected polygons that have overlap or common border (see Section 11.4.3)
 Split polyline (Shift+X)	to split a polyline into two ones in the closest to marker vertex (see Section 11.4.4)
 Split polygons/polylines (Shift+I)	to split several polygons and polylines using “cutting” polyline (see Section 11.4.4)
 Delete segment (Shift+D)	to remove a segment connecting two vertices of polyline/polygon (see Section 11.6.3)
Delete selected vertices (Ctrl+D)	to delete vertices along with adjacent segments (see Section 11.6.6)
 Cut out area from polygon	to cut an area out from a polygon, and to create a ring-shaped polygon (see Section 11.4.5)

Menu items	Function
Fill empty area	to create of a polygon that fills a null area bounded by at least two polygons whose adjacent segments coincide exactly in space (see Section 11.9.3)
Duplicate object	to create several copies of vector objects which are placed in the same layer (see Section 11.4.6)
Select nearest vertex (Shift+S)	to select polyline/polygon vertex closest to marker position (see Section 11.5)
 Connect to point (Shift+V)	to connect creating line to existed one in a closest to marker vertex (see Section 11.5)
 Connect to line (Shift+L)	to connect creating line to existed one in arbitrary place of segment (cm. Section 11.5)
Start from line (Shift+N)	to continue construction of the previously created polyline (see Section 11.5)
Object fragment	to edit a fragment of polyline/polygon (see Section 11.6).
Continue along polyline	to continue creating polyline along existed one to the marker position, to the nearest common vertex, or to selected vertex (see Section 11.7.1)
 Auto-close along polyline(Shift+M)	to draw a border of one polygon along a border of another one (see Section 11.7.2)
 Make vertices of selected objects linked	to link vertices of selected polylines/polygons (see Section 11.3.2)
 Make vertices of selected objects un-linked	to un-link vertices of selected polylines/polygons (see Section 11.3.2)
 Topology verifying	to check vectors topology for errors and correct topology errors (see Section 11.8.1)
Subtract one polygon layer from another	to subtract inactive polygon layer from the active one (see Section 11.9.2)
Intersect one polygon layer with another	to avoid waste space between the layers (see Section 11.9.1)
Find polygons relative position errors	to find and analyse errors of polygons relative position (see Section 11.8.2)
Find polygons with one coinciding point	to find polygons having common points. Search results are displayed on a new layer as points. (see Section 11.8.3)

11.3. Vertices connection

11.3.1. Topological connectivity mode

The system provides the ability to set some vertices connected for created vector objects. The **Topological connectivity mode** is used for that.



Such need arises, for example, in the case of using the **Vectors > Topology > Continue along polyline > To selected vertex** operation.

To make vertices of created vector objects connected, set **Vectors › Topology › Topological connectivity mode** checkbox or click the  button of the **Topology** toolbar.

To disable mode of creation connected vertices set the **Vectors › Topology › Topological connectivity mode** checkbox off or click the  button of the **Topology** toolbar. Continue create vectors in an ordinary mode.



The **Topological connectivity mode** only affects new vertices of created vector objects.

To make vertices of object, created in ordinary mode, perform the following:

1. Select objects with vertices to make them connected.
2. Choose **Vectors › Topology › Make vertices of selected objects linked** or click the  button of the **Topology** toolbar.

11.3.2. Joint points editing mode

The system provides the ability to set some vertices connected, that is used for co-editing of two vector objects. The *Joint points editing mode* is used for that.



Such need arises, for example, in the case of complex roofs editing.

Connected vertices are called the vertices, which are considered a common vertex and are edited simultaneously.



To make connected objects vertices located on specified distance, perform the following actions:

1. Choose **Vectors › Topology › Joint points editing mode** or click the  button of the **Topology** toolbar.
2. [optional] Distance, closer which vertices are considered one common vertex and edited simultaneously, is set in the general settings of the system. To change distance perform the following:
 1. Choose **Service › Settings (Ctrl+Alt+P)**. The **Settings** window opens.
 2. On the **Vectors** tab set the **Points joint swath for topological operations – minimal distance between vertices those are not consider as common vertices**.
3. Connect creating polyline to existed one (see [Section 11.5](#)).
4. Click OK. After that all vertices located at a distance less than the predetermined, are considered connected.



In order to make connected selected objects vertices, perform the following actions:

1. **Select** vector objects in 2D-window.
2. Choose **Vectors › Topology › Make vertices of selected objects linked** or click the  button of the **Topology** toolbar. After that the vertices of selected objects become linked.

To edit connected vertices, perform the following actions:

1. Choose **Vectors › Topology › Joint points editing mode** or click the  button of the **Topology** toolbar.
2. Choose **Edit › Point editing mode** or click the  button of the **Vectors** toolbar.
3. Select one of connected vertices.
4. Press and hold the **Ctrl** key, and press mouse button to move connected vertices.
5. [optional] To remove connected vertices, select one of them and press **Delete**. Connected vertices are deleting together.

In order to unlink selected objects vertices, perform the following actions:

- set the **Vectors › Topology › Joint points editing mode** off or click the  button of the **Topology** toolbar. Objects vertices become unlinked and could be edited separately from each other.
- define which linked vertices should become unlinked:
 1. **Select** a vector object or several objects in 2D-window;
 2. Choose **Vectors › Topology › Make vertices of selected objects un-linked** or click the  button of the **Topology** toolbar. After that the vertices of selected objects become un-linked.

11.4. Object editing

11.4.1. Polylines closing

The system allows to convert polylines to polygons – to close polylines.

In order to close single or multiple polylines, perform the following actions:

1. **Select** polylines in 2D-window.
2. Choose **Vectors › Topology › Close selected polylines (Shift+C)** or click the  button of the **Topology** toolbar. After that selected polylines become closed and converted to polygons.

In order to close a polyline in classifier layer, perform the following actions:

1. **Select** polyline in 2D-window.
2. In the **Classifier** window select a code with P type – polygon.



To check vertices for duplicates in first or end points, in the **Settings** window on the **Vectors** tab set the **Delete/add duplicate vertices while objects closing/unclosing** checkbox
As a result:

- when closing polylines the system checks for duplicates of the first and last vertices, the last vertex is deleted if necessary;
- when closing polygons the first vertex will be added to the end of polyline.

3. Choose **Vectors** › **Topology** › **Close selected polylines (Shift+C)** or click the  button of the **Topology** toolbar. After that the polyline becomes closed and converted to polygon (see [Section 6.7](#)). Selected classifier code is assigned to this polyline.

11.4.2. Polygons unclosing

In order to unclose single or multiple polygons, perform the following actions:

1. **Select** polygons in 2D-window.
2. [optional] When work in layer with **classifier** in the **Classifier** window choose code with the L type (polyline).



To check vertices for duplicates in first or end points, in the **Settings** window on the **Vectors** tab set the **Delete/add duplicate vertices while objects closing/unclosing** checkbox.
As a result:

- when closing polylines the system checks for duplicates of the first and last vertices, the last vertex is deleted if necessary;
- when closing polygons the first vertex will be added to the end of polyline.

3. Choose **Vectors** › **Topology** › **Unclose selected polygons (Shift+B)** or click the  button of the **Topology** toolbar. After that a polygon is converted to a polyline and polygon's segment connecting the first and last vertices. When work with classifier, selected code assign to a new object.

11.4.3. Merging of polylines/polygons

The system provides possibility to merge polylines/polygons, spaced apart from each other or having a common border or overlaps.

To merge two polylines perform the following actions:

1. **Select** two polylines in 2D-window.



The system provides possibility to merge only *two* polylines.

2. [optional] When work with classifier, select in the classifier window code that should be assigned to a new object (see [Section 6](#)).
3. Choose **Vectors › Topology › Merge two polylines (Shift+P)** or click the  button of the **Topology** toolbar.

Selected polylines merge in one, for this a segment adds between two edge vertices of merging polylines.

To merge two or more polygons that share a border or overlap with each other, perform the following actions:

1. **Select** in 2D-window polygons to be merged.
2. [optional] When work with classifier, select in the classifier window code that should be assigned to a new object (see [Section 6](#)).
3. Choose **Vectors › Topology › Merge polygons (Shift+G)** or click the  button of the **Topology** toolbar.

Selected polygons merging to one with the following way: intersection points became to a vertices of a new polygon, overlapped segments deleting after intersection points.



If the polygons have attributes with the same names and mandatory attributes, new polygon is assigned a value of an attribute whose type is the same type as the mandatory attribute.



If merging polygons have attributes with the same names, but does not have mandatory attributes, new polygon is assigned a value of an attribute of the polygon, which attribute type is *text*. Otherwise, new polygon is assigned a value of an attribute of the polygon, which attribute type is – *float*, otherwise – *integer*.

11.4.4. Splitting polylines/polygons

The system provides the following splitting operations of vector objects of active vector layer:

- cutting polyline into two in an arbitrary vertex;
- cutting multiple polygons/polylines of a layer simultaneously using “cutting” polyline.
- cutting polygon located in a layer with classifier using “cutting” polyline.

To split polyline into two ones, perform the following actions:

1. **Select** polyline in 2D-window.
2. Specify by marker an arbitrary vertex of polyline segment.
3. Choose **Vectors** › **Topology** › **Split polyline (Shift+X)** or click the  button of the **Topology** toolbar. After the splitting one polyline is divided into two ones in the vertex closest to marker.

In order to cut several polylines/polygons of the same layer at once using “cutting” polyline, perform the following actions:

1. Create the “cutting” polyline, that intersects objects to be cut.



In order to cut a polyline in several places, cross the polyline as many times as needed.



In order to cut a polygon, cross this polygon through *two* points, otherwise the operation will fail.

Elevations of new vertices of output polygons are calculated in proportion to the elevations of the neighboring vertices of the original polygon before it is split.

2. Select the “cutting polyline”.



The system allows to change attribute values of objects, involving to cutting or merging polylines. To do this in the **Settings** window on **Vectors** tab set the **Set attributes to default value while objects merging/splitting** checkbox on. Source attributes change with the following values: *text* – blank string, *float* – 0.0, *integer* – 0. If an object has obligatory attribute with the same name, its value is used as default value.

3. Choose **Vectors** › **Topology** › **Split polygons/polylines (Shift+I)** or click the  button of the **Topology** toolbar.

The **Parameters** window opens:

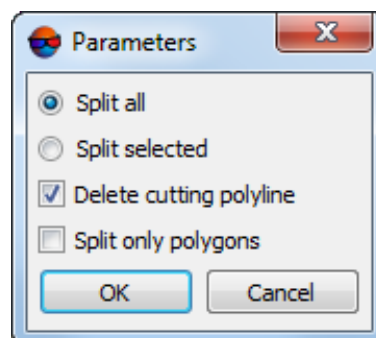

Fig. 195. The Parameters window

Set the options for polygon/polyline splitting:

- **Split all** – the “cutting” polyline splits all the intersecting vector objects into several objects of the same type. New segments are created at the intersections of the “cutting” polyline (see above);
- **Split selected** – see below;
- In order to **delete cutting polyline** after the splitting is performed set an appropriate checkbox;
- In order to **split only polygons** when the both types of objects are intersected by the “cutting” polyline, set an appropriate checkbox.

After that the “cutting” polyline cuts crossed vector objects by several objects of the same type. In points of “cutting” polyline crossing the system creates new segments. After completing the operation the “cutting” polyline is removed.

To split simultaneously some selected polygons/polylines within one layer by the “cutting” polyline, perform the following:

1. Select only the “cutting” polyline which crosses objects to be split;

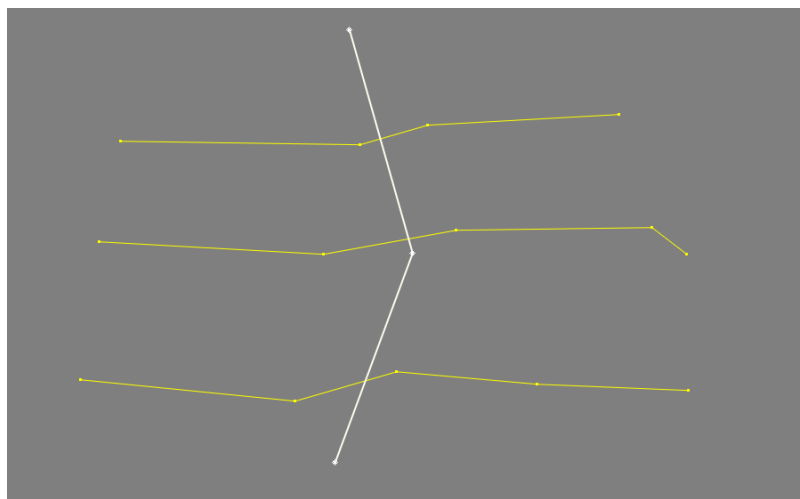

Fig. 196. Selected “cutting” line

2. Add several vector objects to be split to the selected objects;

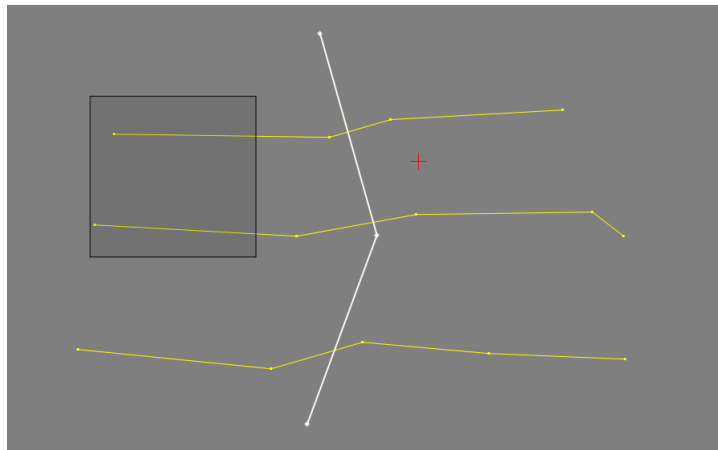

Fig. 197. The “cutting” line and the objects to be cut are selected

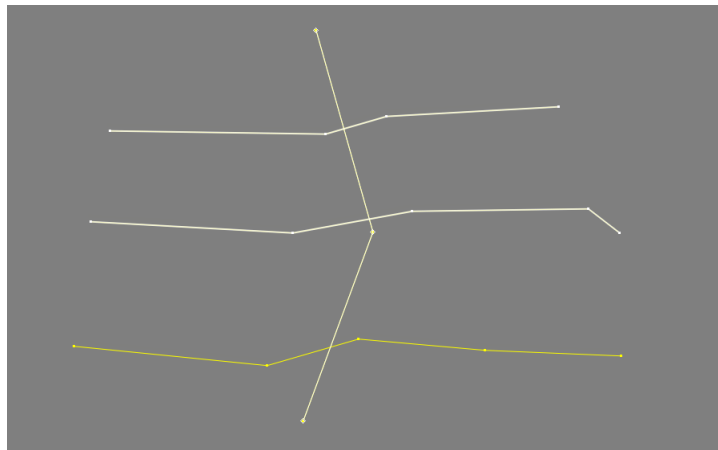

Fig. 198. The “cutting” line and the objects to be cut are selected

3. Choose **Vectors** › **Topology** › **Split polygons/polylines**. The **Parameters** window opens:

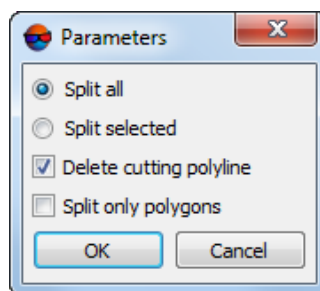

Fig. 199. The Parameters window

Set the options for polygon/polyline splitting:

- **Split all** – the “cutting” polyline splits all the intersecting vector objects into several objects of the same type. New segments are created at the intersections of the “cutting” polyline (see above);
- **Split selected** – the “cutting” polyline splits only the intersected vector objects selected in the item **2**;
- In order to **delete cutting polyline** after the splitting is performed set an appropriate checkbox;
- In order to **split only polygons** when the both types of objects are intersected by the “cutting” polyline, set an appropriate checkbox.

To cut a polygon using “cutting” polyline in a layer with classifier, perform the following actions:



In order to split a polygon in a layer with classifier, convert an object with C type – polygon, into L type – polyline (see [Section 6.7](#)).

1. Create “cutting” polyline which intersects a polygon.



In order to cut a polygon, “cutting” polyline should intersect the polygon in *two* points only, otherwise the operation will fail.

2. Select “cutting polyline”.
3. Choose **Vectors** › **Topology** › **Split polygons/polylines (Shift+I)** or click the  button of the **Topology** toolbar.

As a result “cutting” polyline splits the polygon at two ones, that have the same code as the original polygon. Once the operation is completed, the polyline is removed.

11.4.5. Cut out area from polygon

The system provides opportunity to generate a ring-shaped polygons. To create such a polygon, do the following:

1. **Create** two polygons, which will be used as internal and external borders of the final polygon.



Both polygons, internal and external should be in the same layer.

2. Turn the **points editing mode** on in the **Vectors** toolbar. Turn the **add to selection mode** on in the **Tools** toolbar.

3. Select one vertex both on internal and external polygon.
4. Choose **Vectors** > **Topology** > **Cut out area from polygon**. An area corresponding to internal polygon is subtracted from the main polygon, that allows to create a resulting ring-shaped polygon. The **Cut out area from polygon** window opens.

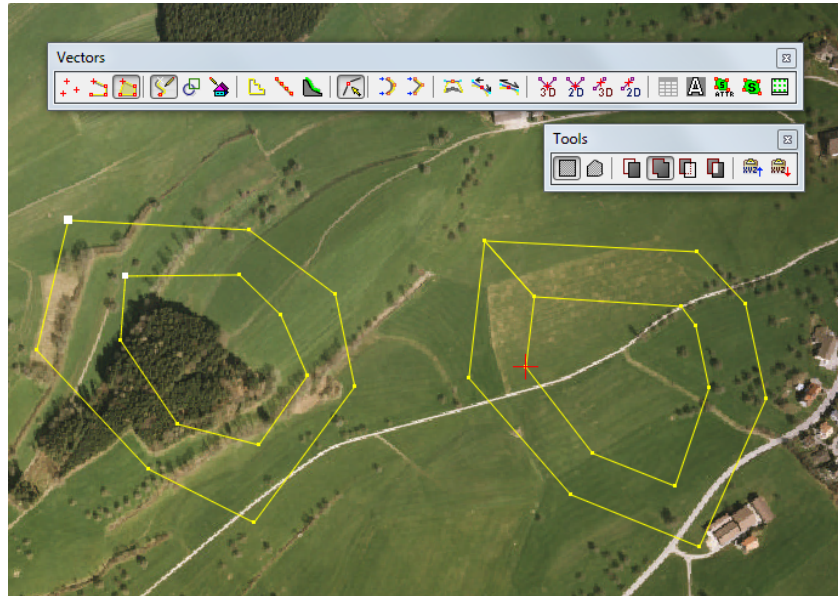

Fig. 200. Cut out area from polygon



Additional segment that is necessary for the system to recognise the resulting polygon as ring-shaped, is located between two vertices, selected prior to subtracting an area from initial polygon.

5.

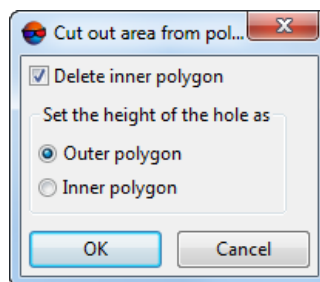

Fig. 201. The Question window

- [optional] Clear the **Delete inner polygon** checkbox to leave the internal polygon as a separate vector object;
- **Set the height of the hole as an outer polygon** or as an **inner polygon**.



Fig. 202. The resulting ring-shaped polygon and the internal polygon as a separate vector object



If the location of an additional segment between the particular selected vertices is not significant, the system allows us to subtract an area from the polygon by a simplified method.

To do this, leaving out paragraphs 2 and 3 select both created polygons and choose **Vectors › Topology › Cut out area from polygon**. Hence, the system will automatically determine the location of the additional segment (between the nearest vertices of the inner and outer polygons).

11.4.6. Duplication of vector objects

The system allows to create several copies of vector objects which are placed in the same layer. To do it perform the following:

1. Turn on **point editing mode** in **Vectors** toolbar.
2. Select *one* vertex of the vector object.
3. Move marker in arbitrary distance to set a position of object copies regarding a parent object (i.e. a vertex of the first object copy corresponding to the selected vertex of the parent object will be placed in marker position, next object copy will be shifted at the same distance at the same direction etc.).

If marker is not moved a position of object copies will be identical to position of the parent object.



The system allows to **select** identical objects *one by one*. With double click of mouse or clicking **S** key **Rectangle selection mode** helps to select all the objects.

4. Choose **Vectors › Topology › Duplicate object**. The **Duplicate object** window opens.

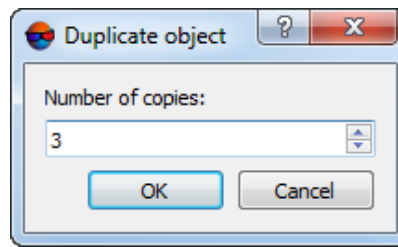

Fig. 203. The “Duplicate object” window

5. Set **Number of copies** and click OK. In the current layer a specified number of object copies is created. These copies are placed in accordance with marker position or identically to the parent object if the marker was not moved.

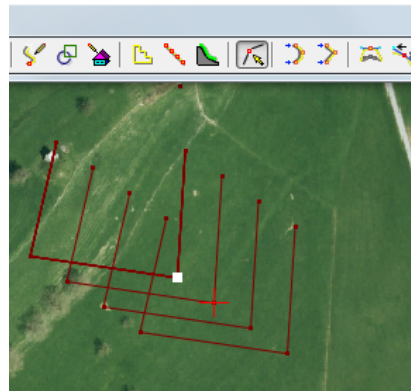

Fig. 204. Object duplication

6. Turn off Point editing mode.



Copying **several** vector objects into existing or new layer is described in “[Vector object copying](#)” chapter.

The system also provides for quick duplication of vector objects. For this, perform the following:

1. **Select** one or more vector objects;
2. Holding down **Ctrl**, **Shift**, and **left mouse button** simultaneously move the marker with the mouse. Copies of the selected vector objects will be created in the new marker position in the same layer.

11.4.7. Filling the attributes after topological operations

Polygons attributes after [topological operations](#) assign to all objects involving in the operation. Thus attributes could be both filling with default values and left unchanged.

The **Set attributes to default value while objects merging/splitting** checkbox in the **Settings** window on **Vectors** tab is use to fill attributes with default values (**Service** › **Settings** menu item (**Ctrl+Alt+P**)).

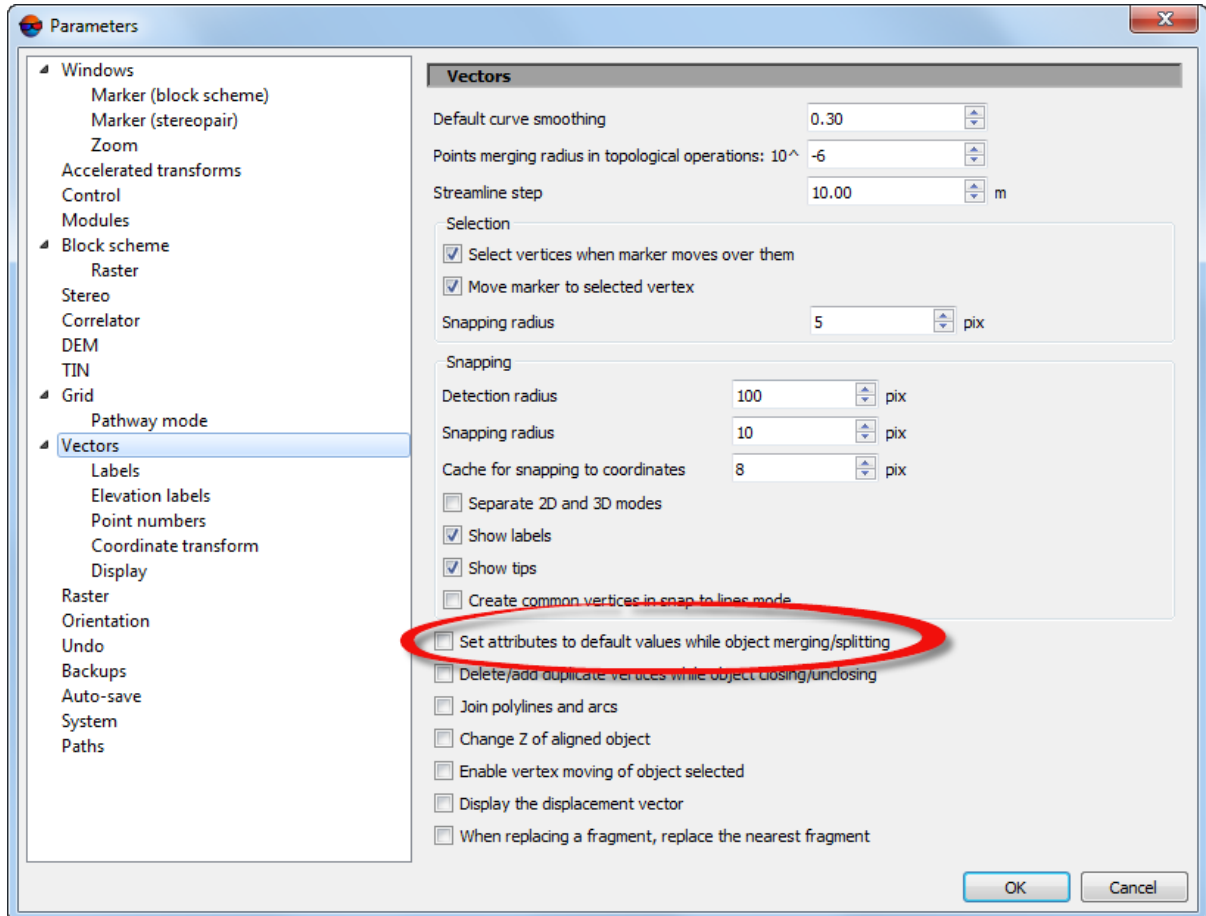



Fig. 205. Vector displaying parameters

Source attributes change with the following values: *text* – blank string, *float* – 0.0, *integer* – 0. If an object has **obligatory attribute** with the same name, its value is used as default value.

Also the system provides possibility to automatic recalculate square of polygons after editing. To do this use the **Vectors** › **Attributes** › **Automatic filling layer's attributes** menu item and the  button of the **Vectors** toolbar.



To perform automatic value recalculation the attribute should has the *float* type.

11.5. Connecting to an object

The system provides possibility to connect to creating vector object to other vector objects.

To connect creating vector object to existing one, execute the following actions:

1. Start to create a vector object (see [Section 5.3](#)).
2. Place marker to vicinity of the existing object vertex.
3. Choose **Vectors › Topology › Select nearest vertex (Shift+S)**. The closest to marker vertex is selected.
4. Press **Insert** to create common vertex.
5. Add more vertices to continue creation of vector object.

In order to select nearest vertex of vector object, place marker in vicinity of the object's vertex and select **Vectors › Topology › Select nearest vertex (Shift+S)**. The closest to marker vertex is selected.

To connect creating polyline to existing one, place marker in vicinity of vertex of existing polyline and select **Vectors › Topology › Connect to point (Shift+V)** or click the  button of the **Topology** toolbar. After that both polylines will have common vertex, which editing leads to change of both polylines at the same time (see [Section 8.4.1](#)).

To connect creating polyline to existing one in arbitrary vertex of polyline segment, place marker in vicinity of vertex of existing polyline and select **Vectors › Topology › Connect to point (Shift+V)** or click the  button of the **Topology** toolbar. After that a new vertex is created at the intersection of the continuation of the polyline created and existing polyline segment. Vertex editing results in change of both polylines at the same time (see [Section 8.4.1](#)).

In order to continue of created polyline, select this polyline in 2D-window and select **Vectors › Topology › Start from line (Shift+N)**. After that both polylines will have common vertex, which editing leads to change of both polylines at the same time.

11.6. Editing of object fragment

11.6.1. Adding/deleting object fragment

The system allows to edit polyline/polygon fragment (see fragment definition in [Section 2.1](#)).

To add vertices to existing polyline/polygon fragment, perform the following actions:

1. **Select** polyline/polygon in 2D-window.
2. Place marker in vicinity of vertex of polyline/polygon fragment beginning, to which it is necessary to add new vertices.

3. Choose **Vectors › Topology › Object fragment › Select start point of fragment (Alt+S)**.
4. Add more vertices to continue creation of polyline/polygon fragment.
5. Press **Esc** to complete polyline/polygon fragment editing.

Perform the following actions to delete a fragment of polyline/polygon:

1. **Select** polyline/polygon.
2. Place marker in vicinity of fragment starting vertex and choose **Vectors › Topology › Object fragment › Select start point of fragment (Alt+S)**.
3. Place marker in vicinity of fragment end vertex and choose **Vectors › Topology › Select nearest vertex (Shift+S)**.
4. Choose **Vectors › Topology › Object fragment › Delete line fragment (Alt+D)**. After that a polyline/polygon fragment is deleted.

11.6.2. Fragment replacing

Perform the following actions to replace a fragment of existing polyline/polygon:

1. Place marker to vicinity of base polyline/polygon vertex, that will be used as the start vertex of fragment to be replaced.
2. Create a new polyline or polygon to replace base fragment. In the process of creating specify direction of created polyline/polygon, which coincides with the direction of the fragment to be replaced.
3. The last vertex of the new polyline enter to vicinity of vertex of the base polyline/polygon, which is the end of the new fragment.
4. Choose **Vectors › Topology › Object fragment › Replace fragment (Shift+R)** or click the  button of the **Topology** toolbar. As a result, a new fragment became a part of base line, all old vertices of base line is deleting.

11.6.3. Segment deleting

Perform the following actions to delete a segment of polyline/polygon:

1. **Select** vector object in 2D-window.
2. Place marker in the vicinity of the vectorization object.
3. [optional] To delete segment from polygon in a layer with classifier, select in the classifier window the L code type (polyline) (see [Section 6](#)).

4. Choose **Vectors › Topology › Delete segment (Shift+D)** or click the  button of the **Topology** toolbar. Selected segment is deleted and selected polyline is divided to a two separate polylines. When segment is deleted from polygon, it convert to a polyline.



If marker is located in the vicinity of the last polyline segment, after deleting remains a polyline and a separate vertex.



When segment is deleted from polygon, it converts to a polyline. In this case when working with classifier also changes the object code.



To delete multiple segments use [removing vertices together with adjacent segments](#) function (**Vectors › Topology › Delete selected vertices**).

11.6.4. Replacing an object's segment by an object's fragment from another layer



Segment – a straight line, connecting two neighbor vertices;



Fragment – a part of polyline/polygon, a set of adjacent vertices/segments of polyline/polygon;



This feature set may be useful when editing *cutlines* (see the “[Orthophotomaps creation](#)” User Manual).

To replace a polygon/polyline segment located in one vector layer by a polygon/polyline segment from another layer, perform the following:

1. Create at least two vector layers. The first layer must contain the vector object, whose *segment* is to be replaced, and the second one must contain the object whose *fragment* will be used as a replacement;
2. Make the second layer editable. Turn on any mode of [snapping](#) to points;
3. Select the first vertex of polygon/polyline fragment to be used as a replacement of the object's segment from another layer. Snapping to vertices, align it with the first vertex of the specified segment;
4. Select the final vertex of polygon/polyline fragment to be used as a replacement. Snapping to vertices, align it with the second vertex of the segment to be replaced. Turn off the snapping mode;
5. Make the first layer editable. Turn on the [point editing mode](#). At once, select the first and second vertices of the segment to be replaced;
6. Choose **Vectors › Topology › Object fragment › Replace selected segment by fragment from other layer**. As a result, a copy of the selected object fragment

from another layer is formed in place of the selected vector object segment. The vector object whose fragment was used as a template remains unchanged.

11.6.5. Reverting vertices order

To change vertices order in polylines or polygons select **Vectors** › **Topology** › **Object fragment** › **Reverse vertices order in line objects**. As a result vertices order of selected polyline/polygon is inverted.



This operation is necessary during replacing a polyline/polygon fragment to define necessary area.

11.6.6. Removing vertices together with adjacent segments

To remove vertex or multiple vertices together with the adjacent segments perform the following actions:

1. Turn the [points editing mode](#) on.
2. Select single or multiple vertices of a polyline or polygon.
3. Choose **Vectors** › **Topology** › **Delete selected vertices** or press **Ctrl+D**. Selected vertices are removed together with adjacent segments, and edited polyline is divided into several separate polylines. When vertices with adjacent segments are removed from a polygon, it is converted into a polyline.

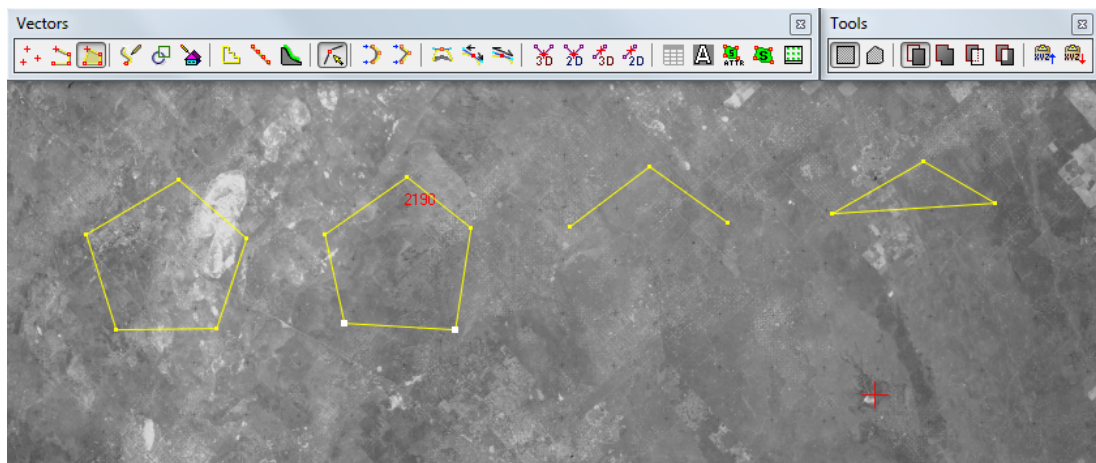

Fig. 206. Removing vertices (right vector object) and removing vertices together with adjacent segments (left vector object)



To select multiple vertices use [objects group selection](#) or turn the [add to selection](#) mode on in the **Tools** toolbar.



In order to remove just polygon/polyline vertex, select the vertex and press **Delete** (see [points editing mode](#)).

11.7. Creating common border

11.7.1. Continuing along polyline

The system allows to create objects common border using the following ways:

- to marker position;
- to closest common vertex;
- to selected vertex.

To create polyline along another polyline up to marker position, perform the following actions:

1. Start to create a polyline (see [Section 5.3.2](#)).
2. Place marker to the arbitrary point close to an existing polyline.
3. Choose **Vectors** › **Topology** › **Continue along polyline** › **To marker position (Shift+A)** or click the  button of the **Topology** toolbar.

After that the last common vertex of two polylines is created in intersection point of existing polyline and projection of marker position on this polyline.



If marker is located “far” from a polyline segment, the system creates additional segment of a new polyline, which is continued to the closest vertex.

4. Press **Enter** to complete polyline creation. After that a new and existing polylines have common border with coinciding vertices between the first and the last selected vertices.



To continue creating polyline along another polyline up to vertex, perform the following actions:

1. Start to create a polyline (see [Section 5.3.2](#)).
2. Place marker to the vicinity of an existing polyline vertex.
3. Choose **Vectors** › **Topology** › **Select nearest vertex (Shift+S)**. The closest to marker vertex is selected.
4. Choose **Vectors** › **Topology** › **Continue along polyline** › **To nearest joint vertex (Shift+F)** or click the  button of the **Topology** toolbar. The system creates common part of new and existing polylines.

To continue creating polyline/polygon along other vector objects up to necessary vertex, perform the following actions:



Prior to perform the operation set the **Vectors › Topology › Topological connectivity mode** checkbox on or click the  button of the **Topology** toolbar (see [Section 11.3.1](#)), otherwise, the operation is performed incorrectly.

1. Start to create a vector object (see [Section 5.3](#)).
2. Place marker to the arbitrary point close to an existing polyline.
3. To connect creating polyline to existing one select one the following ways:
 - choose **Vectors › Topology › Connect to point (Shift+V)** or click the  button of the **Topology** toolbar; both polylines/polygons have common vertex;
 - choose **Vectors › Topology › Connect to line (Shift+L)** or click the  button of the **Topology** toolbar; a new vertex is created at the intersection of the continuation of the polyline created and existing polyline segment.
4. Place marker in vicinity of the last common vertex and choose **Vectors › Topology › Select nearest vertex (Shift+S)**.
5. Choose **Vectors › Topology › Continue along polyline › To selected vertex (Shift+Z)** or click the  button of the **Topology** additional toolbar. After that a new and existing polylines/polygons have common external border with coinciding vertices.

11.7.2. Auto-close along polyline

The system provides a possibility to draw part of one polygon along the other. The function is used when common fragments of two vectorization objects coincide precisely (for example, land plots borders).

In order to draw part of one polygon along the other perform the following actions:

1. Place marker in vicinity of vertex of existing polygon, to which it is necessary to draw a fragment of other polygon.
2. Press **Insert** to create the first vertex of new polygon. Add vertices to continue polygon creation.
3. Place marker to the right of vertex of existing polygon, from which it is necessary to draw a fragment of other polygon.
4. Press **Insert** to add the last fragment vertex.

5. Choose **Vectors › Topology › Auto-close along polyline (Shift+M)** or click the  button of the **Topology** toolbar. After that a new polygon fragment is drawn along the existing one in boundaries specified by user.
6. Press **Enter** to complete polygon editing.

11.8. Topology control

11.8.1. Topology verifying

In some cases during vectorization there could be mistakes in the topology of vector objects. In order to check for errors and fix them, the system provides the opportunity to find and fix the topology of vector objects.

In order to find and correct topology errors, perform the following actions:

1. Choose **Vectors › Topology › Verify topology** or click the  button of the **Topology** additional toolbar. The **Parameters** window opens.

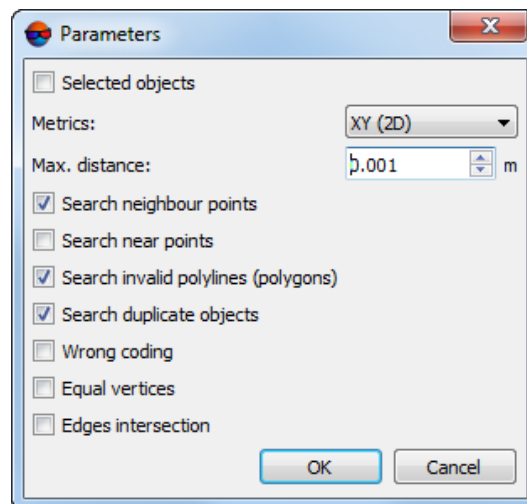

Fig. 207. Parameters of topology check

2. [optional] In order to verify topology of just selected objects, set the **Selected objects** checkbox.
3. In the **Metrics** list specify whether space is used to search for topology errors: XY (2D) or XYZ (3D).
4. Set one or several checkboxes to define the following parameters of topology errors search:
 - **Search neighbour points** – is used to search for coinciding adjacent vertices of object, the distance between them is less than the **Max. distance** value;

- **Search near points** – is used to search for coinciding vertices, located on different polylines/polygons or points on objects vertices, the distance between them is less than the **Max. distance** value;
- **Search invalid polylines (polygons)** – is used to search for polylines with the number of vertices less than two and polygons with the number of vertices less than three;
- **Search duplicate objects** – is used to search for coinciding polylines/polygons or point objects, which vertices completely coincide;
- **Wrong coding** – is used to search for vector objects, incorrectly linked to a classifier code.



Searching of **Wrong coding** objects is applied only for vector layers with classifier.

- **Equal vertices** – allows to find vertices of objects that consider to vertices of other objects;
 - **Edges intersection** – finds intersecting segments of objects.
5. Click OK. The system starts operation of topology verifying. In the case of error detection the system opens the **Errors correction** window. Each line of the list contains the error name and XY coordinates of the error.

Error	X	Y	Z
Invalid line	580623	5.4102e+06	503.597
Invalid line	580355	5.41073e+06	480.454
Invalid line	580328	5.41065e+06	488.925
Invalid line	580513	5.40965e+06	490.716
Invalid line	580584	5.40969e+06	491.832
Neighbor points	580738	5.41018e+06	503.461
Neighbor points	580647	5.40992e+06	494.423
Neighbor points	580803	5.4096e+06	490.999
Neighbor points	580945	5.41095e+06	521.935
Neighbor points	580324	5.41011e+06	480.8

Fig. 208. Correction of topology errors

6. To pass to the point in 2D-window select the vertex in the list by mouse double click.

11.8.2. Check polygons relative position errors

The system provides possibility to search and analyse errors of polygons position (crossings, intersections and presence of “holes”). To find such errors select **Vectors** › **Topology** › **Find polygons relative position errors**.

If errors are found the system displays the window with information about total amount of polygons and amount of each error type. For each error type the system creates the layer – *Intersections*, *Self-intersections* or “*Holes*” – in which polygons are located at the intersection of initial layer polygons or “holes”.

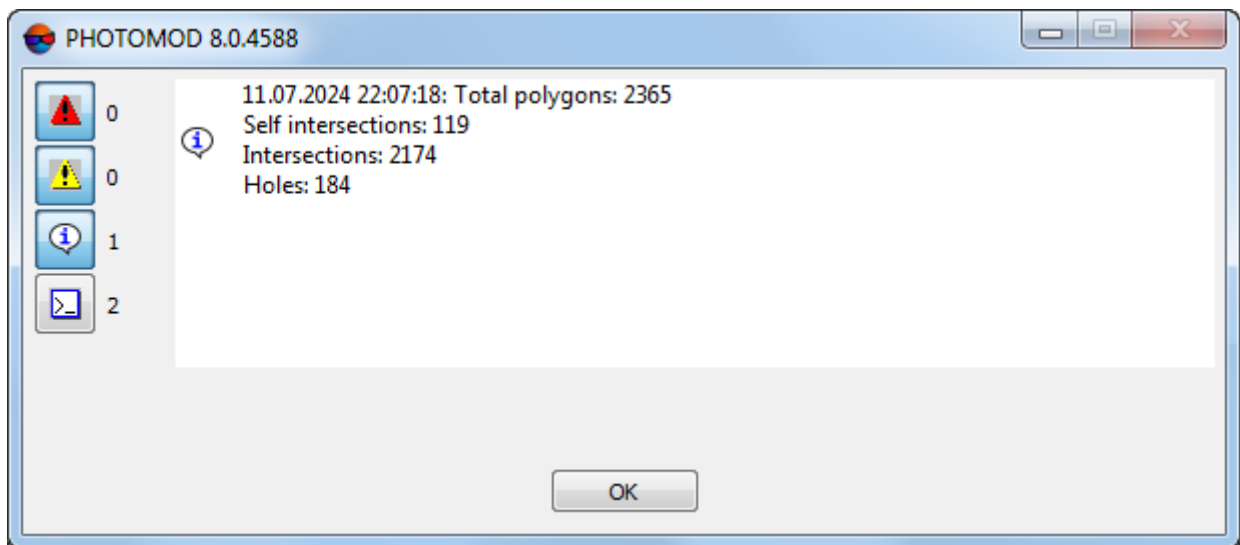

Fig. 209. Information window about topology errors

11.8.3. Search for polygons with coinciding points

The system provides possibility to search for polygons having *coinciding points* (the points with [exact spatial matching](#) in XY plane). To find such points make polygon layer editable and choose **Vectors** › **Topology** › **Find polygons with coinciding points**.

The system opens informational window indicating total number of points found (equals 0 if there are no points found). When the search is complete the system creates a new layer (copy of original polygons layer), containing *just coinciding points* (but not polygons themselves).

A new layer has a name like – *Common points (Vectors(2))*, where “*Vectors*” - is a name of initial layer which contains polygons being investigated, and “2” number means that the layer is a copy of “*Vectors*” layer. After next searches (for example, after adding new polygons to “*Vectors*” layer) resulting layers will have indexes “3”, “4”, etc.



If a point of one polygon is situated on the edge of another polygon (e.g. due to [Snapping](#) to lines or Snapping to medians), it is considered to be common.



Vertices of different polygons, the distance between which does not exceed the **Points joint swath for topological operations**, are also considered to be common.



If XYZ coordinates of two points coincide, only one point is moved to a new layer. If only XY coordinates of two points coincide, both point are moved to a new layer.

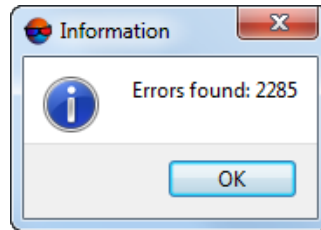

Fig. 210. Information window with the search results

11.9. Editing of polygonal layer

11.9.1. Layers intersection

The system allows to intersect two layers with only polygons. At that polygons and its parts placed out of polygons of selected layer is deleted from the active vector layer.



It is used, for example, to edit overlap areas of specified sheets images during processing satellite images, when polygons created by images edges.



It is recommended to perform operation of layers intersection prior to operation of layers subtracting.

To intersect a polygonal layer with another one, perform the following actions:

1. Make active the image boundaries layer in the Manager.
2. Select **Vectors > Topology > Intersect one polygon layer with another**. The **Intersect with polygon layer** window opens.

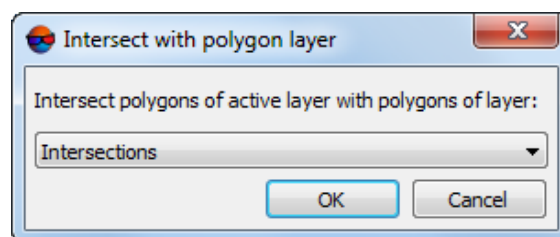

Fig. 211. Intersection of one polygon layer with another

3. Select the layer you want to cross with the active layer.
4. Click OK. After that is deleted polygons from active layer placed out of inactive polygon layers.

11.9.2. Layers subtraction

The system allows to subtract one polygonal layer from the other. At that polygons and its parts placed inside of polygons of selected layer is deleted from the active vector layer.

Perform the following actions to do this:

1. In Manager make active a source layer, from which you want to subtract the other layer of polygons.
2. Select **Vectors** › **Topology** › **Subtract one polygon layer from another**. The **Subtract polygon layer** window opens.

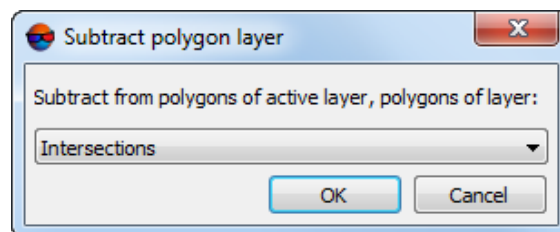

Fig. 212. Subtracting one polygon layer from another

3. Select a layer to be subtracted from an active layer.
4. Click OK. As a result, from polygons of active layer remove area inside of polygons on active layer. Polygon edge of active layer creates by polygon edge of selected layer.

11.9.3. Filling null areas

The system provides for the creation of a polygon that fills a null area bounded by at least two polygons whose adjacent segments **coincide exactly in space**.



This function may be useful during vectorization of areal objects (for example, a lake and its shoreline).

To do this, perform the following:

1. Using any of the modes of **snapping to vertices**, create at least two vector polygons that limit a null area which is to be filled with a polygon;



These polygons can be located within various vector layers and can have various elevations.

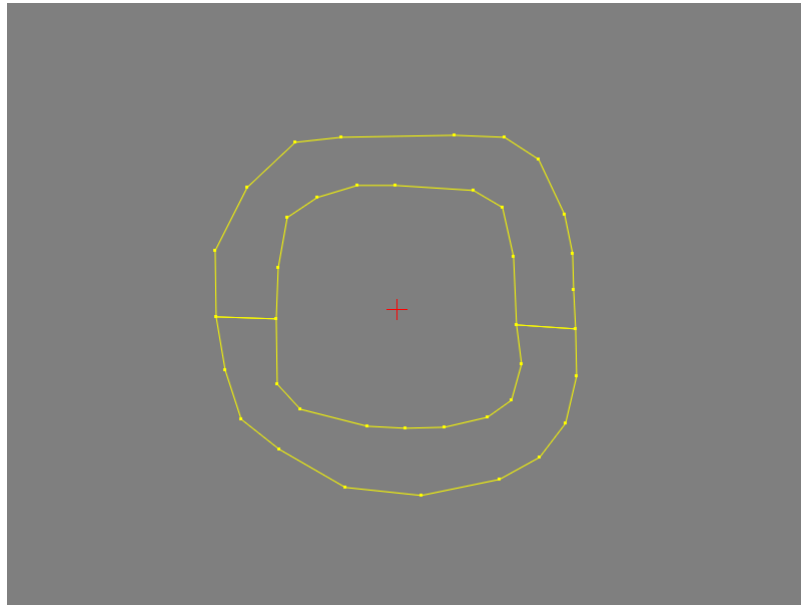

Fig. 213. A null area limited by polygons whose adjacent segments coincide exactly in space

2. Move the marker to the null area that is need to be filled;
3. Choose **Vectors › Topology › Fill empty area**. A new polygon that fills the null area which is limited by parent polygons is created in the active vector layer.

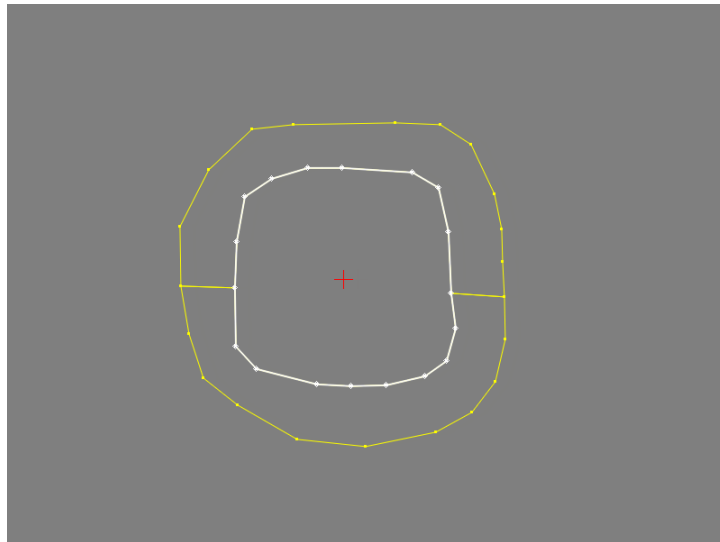

Fig. 214. A polygon filling a null area

To attach a created polygon filling a null area to the [classifier code](#), perform the following:

1. Open or create a vector layer with a classifier containing polygons which limit a null area to be filled with a polygon;

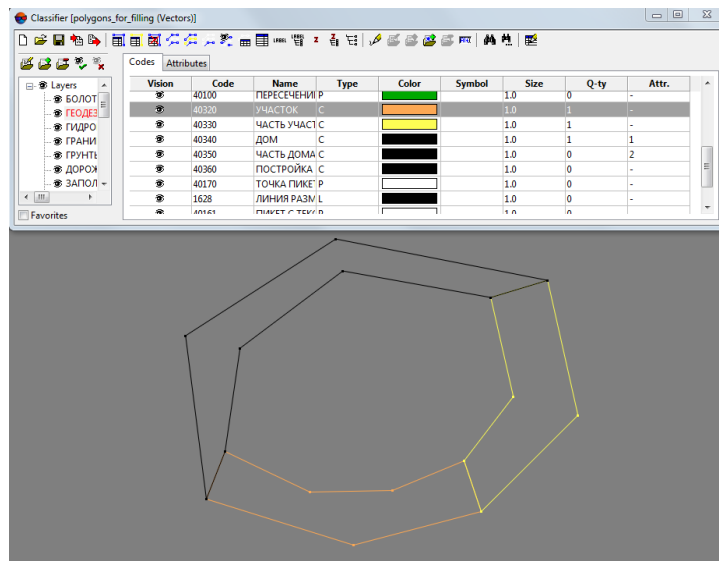

Fig. 215. A null area limited by polygons located in the layer with the Classifier

2. Move the marker to the null area which is need to be filled;
3. Select the appropriate classifier **code** in the **Codes** tab in the **Classifier** window;
4. Choose **Vectors** › **Topology** › **Fill empty area**. A new polygon that fills the null area which is limited by parent polygons is created in the active vector layer. This polygon is attached to the selected classifier code.

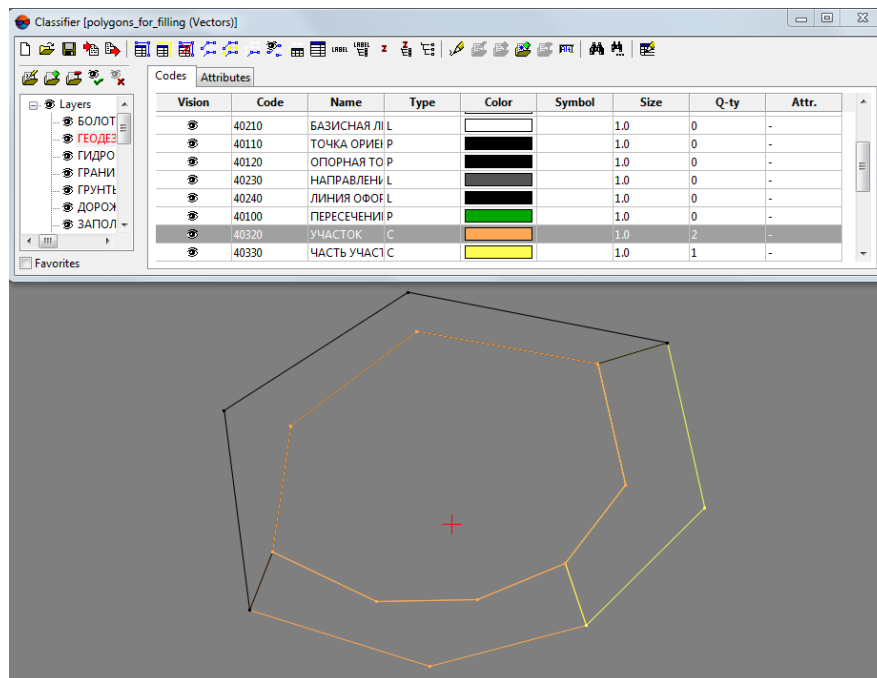

Fig. 216. A polygon filling a null area with the attached Classifier code

12. Vector data editing using *.x-mdata file

12.1. Vector data conversion to *.x-mdata

The system provides possibility to edit big volumes of vector data using separate file with the *.x-mdata extension. Data processing is performed step by step in each area containing points. After the processing is used to build TIN and DEM.

To create vector data file with the *.x-mdata extension, perform the following actions:

1. Select **Vectors** > **Convert objects to x-mdata**. The **Parameters of conversion to x-mdata** window opens.

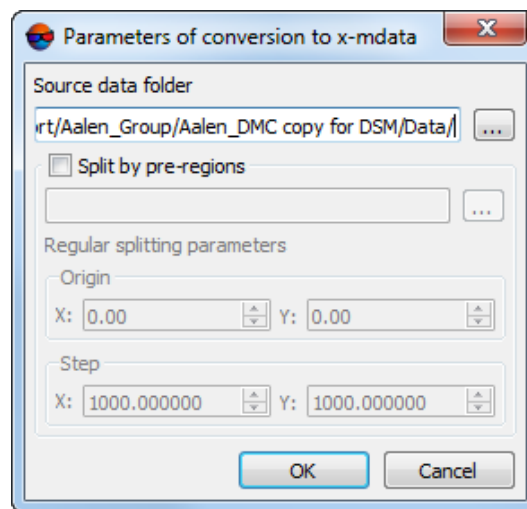

Fig. 217. Vector data conversion to x-mdata







2. In the **Source data folder** field select source folder, where to perform vector data search.
3. [optional] To edit vector data in stereopairs overlap area, set the **Split by pre-regions** checkbox and select file with pre-regions file in the project.
4. [optional] To change coordinates of grid's origin, in the **Regular splitting parameters** section, in the **Origin** sub-section input necessary origin coordinates.
5. [optional] To change grid's step in the **Regular splitting parameters** section, in the **Step** sub-section input grid step value.
6. Click OK. The **Save** window opens.
7. To the **Resource name** field input a name of new file with *.x-mdata extension.
8. Click the **Save** button to complete creation of vector data file.

12.2. *.x-mdata editing





The system provides possibility to process vector data by selected grid sheets or by stereopairs overlap areas, that contain points.

The **Edit x-mdata** toolbar is used to edit points.

The toolbar contains the following buttons:



-  – allows to open a layer containing data from file with *.x-mdata extension;
-  – allows to close a layer containing data from file with *.x-mdata extension;
-  – allows to open for editing a layer with data from selected grid sheet;
-  – allows to open for editing a layer with data from a grid sheet, where the marker is located;
-  – allows to open for editing a layer with data from all linear objects, located on images;
-  – allows to save changes on selected grid sheet;
-  – allows to close selected grid sheet;

To edit vector data file with the *.x-mdata extension, perform the following actions.

1. Select **Vectors > x-mdata editor**. The **Edit x-mdata** toolbar shows.
2. Click the  button of the **Edit x-mdata** toolbar to open a layer containing data from file with *.x-mdata extension.
3. Select a grid sheet for further editing of vector data using one of the following ways:
 - by mouse click with pressed the **Shift** key select one of the grid sheets by mouse and click the  button of the **Edit x-mdata** toolbar.
 - place the marker to vicinity of a grid sheet and click the  button of the **Edit x-mdata** toolbar.
4. [optional] To edit linear objects located on images click the  button of the **Edit x-mdata** toolbar.
5. Click the  button of the **Vectors** toolbar to enable point objects input mode.
6. Edit consistently points on selected grid sheet.



If point is input or moved out of the selected grid sheet area, it is automatically saved in the location where it was input.

7. Click the  to save changes on a layer with data of selected grid sheet.
8. Click the  to close a layer with data of selected grid sheet;
9. Continue to edit other grid sheets.
10. To end process file click the  button or close the **Edit x-mdata** toolbar.

13. Import of vector objects

13.1. Import from ASCII

The system provides possibility to import vector objects from the ASCII format. In the ASCII format each vector object is marked as sequence of points with three-dimensional coordinates.

Files of this format has the *.txt extension. The file contains a sequence of records delimited by the * symbol. Each entry describes an object that is a point or polyline/polygon. The record consists of object code and a series of lines with three-dimensional coordinates of vertices separated by a comma. Example of ASCII-file contents:

Road

L 1234 67.4567 67.565 453

L 1245 6.7439 570.860 958

*

Point

L 1257 85.2198 76.459 56

*

In order to import vector objects from the ASCII format perform the following actions:



If the layer with the classifier was created earlier, when you import the file from ASCII format layer attributes are preserved.

1. Choose **Vectors** › **Import** › **ASCII**. The **Import from ASCII format** window opens.

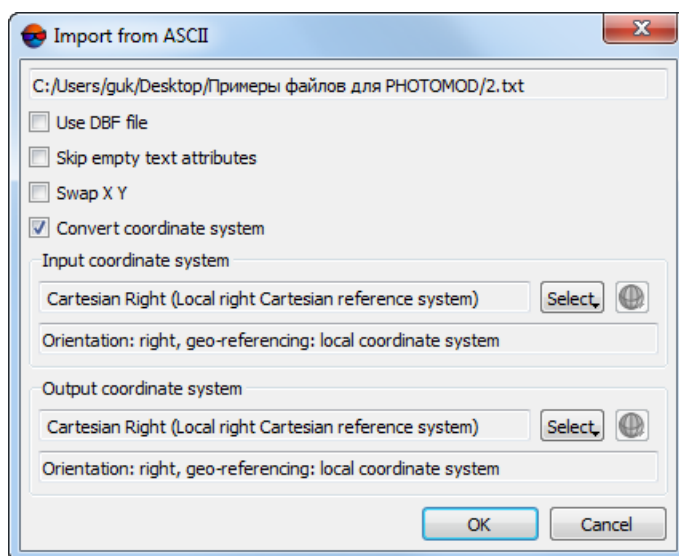

Fig. 218. Import from ASCII

2. [optional] In order to define standard parameters set the **Use DBF file**, **Swap X Y** and **Convert coordinate system** checkboxes on (see [Section 10.5](#)). If all checkboxes are set on, then when importing first XY-coordinates of points are swapped, then the system recalculates the coordinates.



If the **Swap X Y** checkbox is cleared, the vector objects will be imported in the right coordinate system. Otherwise, in the left one.

3. [optional] To prevent creating text attributes without value during import, set the **Do not create empty text attributes** checkbox on.



When the **Do not create empty text attributes** checkbox is on, in some cases a data loss may occur.

4. Click OK to complete the import operation.

13.2. Import from ASCII-A

The system provides possibility of vector objects import from ASCII-A format. ASCII-A format contains information about coordinates of vector objects vertices, as well as information about object type, layer number, attributes name and value.

Files of this format has the *.txt extension. Unlike ASCII, in ASCII-A format object description contains first lines that describe object type and attributes.

Example of ASCII-A file content:

```
L 101 1 13 4
OBJECT_NAME=Railway
OBJECT_COLOR=3
OBJECT_SYMBOL=R
OBJECT_SIZE=5.5
545566.505,473671.817,77.850
545715.103,473656.072,78.310
545782.001,473567.393,78.156
545860.428,473463.139,77.974
545847.506,473339.305,77.380
545795.032,473249.288,76.795
545517.126,473365.500,76.318
545269.605,473463.426,75.869
```

*

The first line of each section has the following structure:

Type, code, layer, N1, N2, where:

- Type - the symbol describing an object type:
 - L – polyline;
 - P – point;
 - C – polygon.
- Code is an object code;
- Layer is a number of layer;
- N1 – the total number of lines where there is a description of the object in the file;
- N2 – the number of lines where there is a description of the object attributes in the file;

This is followed by lines with attributes description that have the following form:

Name=Value

Then there are lines with the object vertices coordinates. The sequence of records is delimited by * symbol.

In order to import vector objects from the ASCII-A format perform the following actions:

1. Choose **Vectors** > **Import** > **ASCII-A**. The **Import from ASCII-A format** window opens.

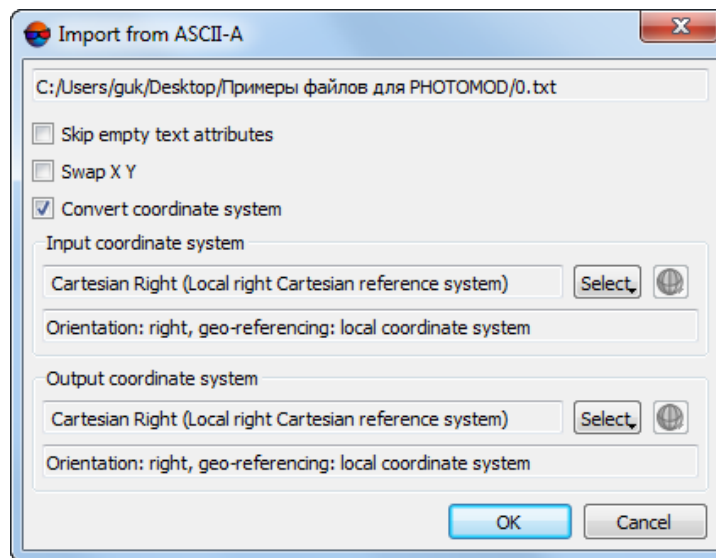

Fig. 219. Import from ASCII-A

2. [optional] In order to define additional parameters set the **Swap X Y** and **Convert coordinate system** checkboxes on (see [Section 10.5](#)). If all checkboxes are set on, then when importing first XY-coordinates of points are swapped, then the system recalculates the coordinates.



If the **Swap X Y** checkbox is cleared, the vector objects will be imported in the right coordinate system. Otherwise, in the left one.

3. [optional] To prevent creating text attributes with an empty value during import, set the **Do not create empty text attributes** checkbox on.



When the **Do not create empty text attributes** checkbox is on, in some cases a data loss may occur.

4. Click OK to complete the import operation.

13.3. Import from CSV

The system provides possibility to import vector objects (with their attributes) from the CSV format. CSV format is exchange text format, which is supported by major applications in different industries. It is used as exchange format when special geospatial data formats are not applicable for some reason. In particular, CSV format is often used the exchange data about orthomosaic splitting into sheets.

CSV-files with *.csv and *.txt extensions are supported.

In order to import vector objects from the CSV format perform the following actions:

1. Choose **Vectors > Import > CSV**. The **Import from CSV format** window opens.

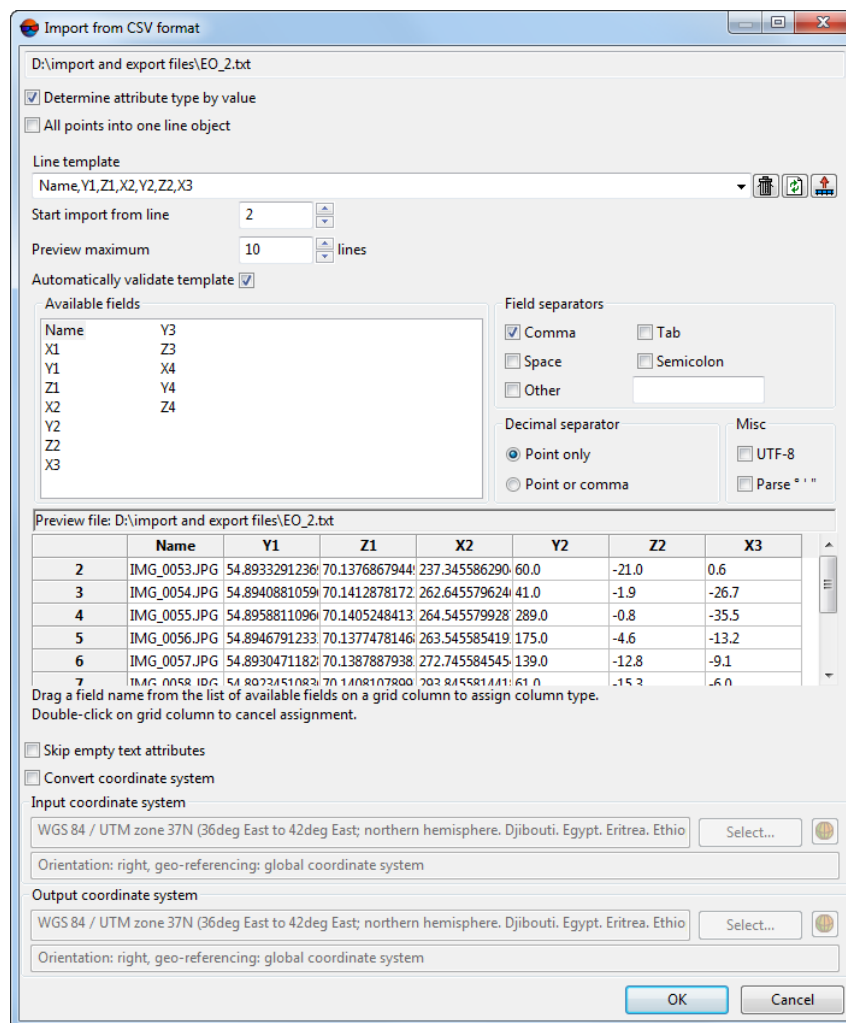

Fig. 220. Import from CSV

2. [optional] To prevent creating text attributes with an empty value during import, set the **Do not create empty text attributes** checkbox on.



When the **Do not create empty text attributes** checkbox is on, in some cases a data loss may occur.

3. [optional] After import the text type is assigned to all attributes. To assign the float type for attributes with numeric value (see [Section 7.2.1](#)), set the **Define attribute type by value** checkbox on.
4. [optional] To import flight path files set the **All points into one line object**.
5. The **Line template** field displays the list of fields, contained in each line of imported CSV file:
 - Name – object's name;
 - X_n , Y_n , Z_n , where n – integer number, coordinates of the first and subsequent vertices of the object;
 - * – missed field during import.

All objects are saved using the same template. Each line of a file contains the same number of fields, that equals to number of fields in template. Lines which does not correspond to the template, are skipped. To all vertexes two (for 2D objects import) or three coordinates are specified.

In order to setup active template, perform one of the following actions:

- drag a field name from the **Available fields** list to the **Preview file** table column. After that the template in the **Line template** field is changes. To cancel a field selection, double click the **Preview file** table column;
- change the template manually in the **Line template** field. Column type of the **Preview file** table change automatically.

The  button is used to return to default template: Name X Y Z.

The  button is used to compare the **Line template** field with data shown in the **Preview file** table.



The active template corresponds only to lines shown in the **Preview file** table.

The  button is used to replace specified field names by field values taken from the first line of the **Line template** table.



It is possible to specify any names for *vectors* import. For import of *laser scanning* data the field names from the list of available names are specified.



To import together with vector objects their attributes recorded in a *.csv file together with object vertex coordinates, click the  button, and if it is necessary to import only a part of the attributes, change the line template manually in the **Line template** field.

To view attributes of vector objects after import, select a vector object and choose **Window › Object attributes**.



For correct import of vector objects with attributes, the first line of the *.csv file must be filled in appropriately.



Пример файла *.csv, содержащего координаты точечных векторных объектов (пикетов) и их атрибуты. The example of *.csv file containing coordinates of point vector objects and their attributes is the following:

```
x,y,z,attribute name 1,attribute name 2
738181.714,260663.890,570.127,attribute value 1,attribute value 2
738186.630,260691.792,567.264,attribute value 1,attribute value 2
<...>
738341.832,260696.672,572.350,attribute value 1,attribute value 2
```

6. [optional] Set the following additional parameters:
 - **Automatically validate template** – allows to use template, specified in the first string of file; set the checkbox off to change template manually;
 - **Start import from line** – allows to choose file string from which is data import starts;
 - **Preview maximum** – allows to define number of strings displayed in the **Preview file** table (10 by default).
7. In the **Available fields** section select necessary field name and drag it to the table column. To cancel the field name double click the column header.
8. In the **Field separators** section set on one or multiple checkboxes to specify possible fields delimiter symbol: **comma**, **space**, **tab**, **semicolon** or **other**. Default settings are comma and space.
9. In the **Decimal separator** section setup the following parameters:
 - **Point only** – to use point only as a decimal separator in coordinates;
 - **Point or comma** – to use both point and comma as a decimal separator in coordinates.



If a **comma** is used as *field separator*, it is strongly not recommended for the **Decimal separator** use **point or comma**, since objects will import incorrect.

10. In the **Misc** section set the following checkboxes:

- **UTF-8** – is used to recognize text in Unicode coding;



Unicode – symbols encoding format that allows to provide symbols of almost all written languages.

- **Parse ° ’ “** – is used to recognize records of projection centers or GCP.



When using this parameter it is highly recommended to check recognizing correctness after import operation. To do this **select** any point in 2D-window and check coordinates values in the **Marker** window.

11. The **Preview file** table contains data of imported file. Fields type according to the template, located in the **Line template** field, are automatically assigned to the table columns.



The * symbols marks columns with data which is not imported.

12. [optional] To change output objects coordinate system set the **Convert coordinate system** checkbox on.

13. Click OK to import.



Current template saves after import and adds to a drop-down list.

To check for errors the import results of the catalogue of projection centers or GCP **select** a point in 2D-window; the **Marker** window will display point's coordinates in DMS format.

13.4. Import from DGN

The system provides possibility of vector objects import from DGN V7 format (other possible names – ISFF DGN/Intergraph DGN). This is exchange format with *.dgn extension, that is used in the *MicroStation 7*.



The DGN V8 format, that is used in the *MicroStation 8* and later versions is not supported. In this case to perform data exchange it is necessary in *MicroStation* to convert DGN file to V7 format.

In order to import vector objects from the DGN format perform the following actions:

1. Choose **Vectors > Import > DGN**. The **Import from DGN format** window opens.

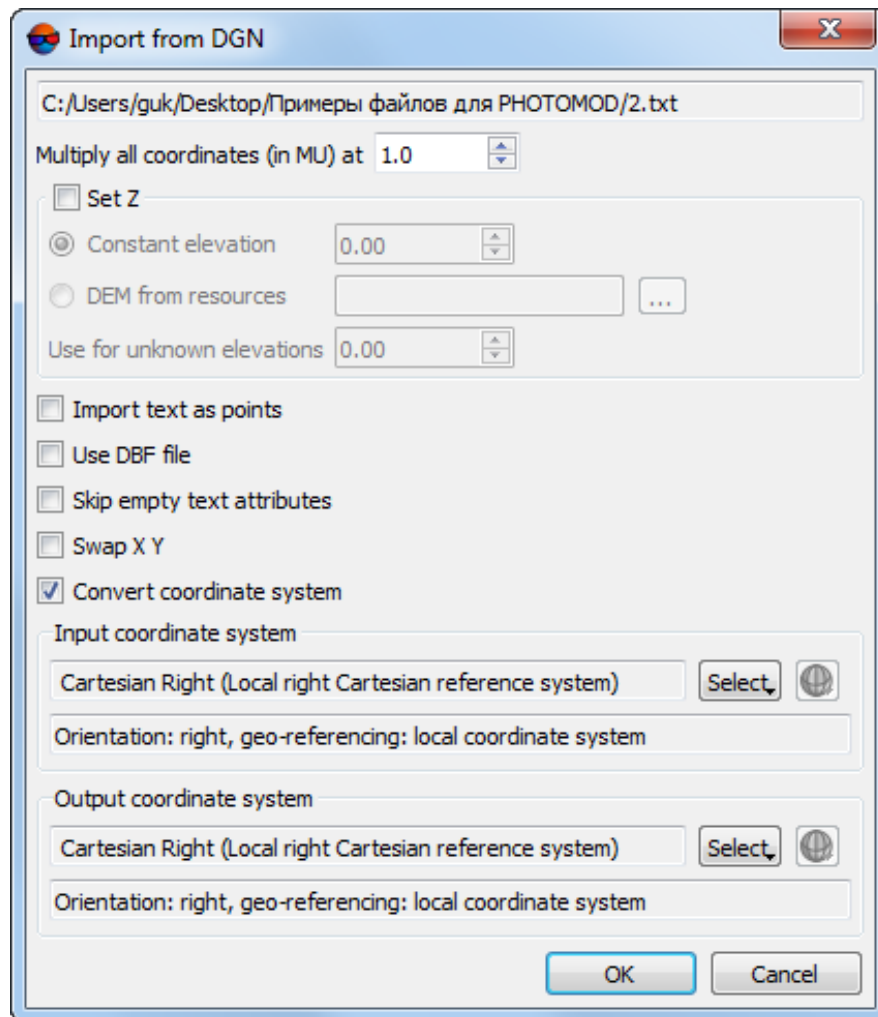

Fig. 221. Import from DGN

2. [optional] To multiply all coordinates of objects vertices during import specify the coefficient in the **Scale** field.
3. In the Z for 2D objects section define one of the calculation ways of Z coordinates of objects vertices:
 - **Constant elevation** – allows to assign the same value of Z coordinate to all objects;
 - **DEM from resources** – allows to select a resource with DEM containing Z values. Click the **...** button to choose file in active profile resources.
 - **Use for unknown elevation** – allows to fill the empty DEM cells with a predetermined elevation values.

4. [optional] To convert text objects from DGN file into point objects with label containing source object text, set the **Import text as points** checkbox on (see [Section 6.5](#)).
5. [optional] To define additional parameters set the **Use DBF file**, **Swap X Y** and **Transform reference system** checkboxes on (see [Section 10.5](#)). If all checkboxes are set on, then when importing first XY-coordinates of points are swapped, then the system recalculates the coordinates.
6. [optional] To prevent creating text attributes with an empty value during import, set the **Do not create empty text attributes** checkbox on.



When the **Do not create empty text attributes** checkbox is on, in some cases a data loss may occur.

7. Click OK to complete the import operation.

13.5. Import from DXF

The system provides possibility of vector objects import from DXF format. This is exchange format with *.dxf extension, that is used in the *AutoCAD programs*.



The DXF format, that is used in the *AutoCAD R15* and later versions is not supported. In this case to perform data exchange it is necessary in *AutoCAD program* to convert DXF file to R14 format.



In case when 3D face objects are to be imported from the DXF format, for the user's convenience the system provides for immediate building the TIN layer on the base of imported 3D face objects (**Terrain > TIN > Import > DXF** – see the “[DTM Generation](#)” User Manual).

A user is able to import 3D face objects as a vector layer (see this chapter) and further to build a TIN on its base (see the “TIN creation” chapter in the “[DTM Generation](#)” User Manual).

The settings for both ways of data import from the DXF format are the same, because in any case, during import, a vector layer will be created at first, which will either be used for automatic TIN construction, or processed somehow by the user, depending on specific needs.

Note, that 3D face objects can be represented both by triangles and polygons. Their structure will be completely maintained when importing 3D face objects as a vector layer. When building a TIN (in every way) polygons will be split into triangles anyway.

In order to import vector objects from the DXF format perform the following actions:

1. Choose **Vectors > Import > DXF**. The **Import from DXF format** window opens:

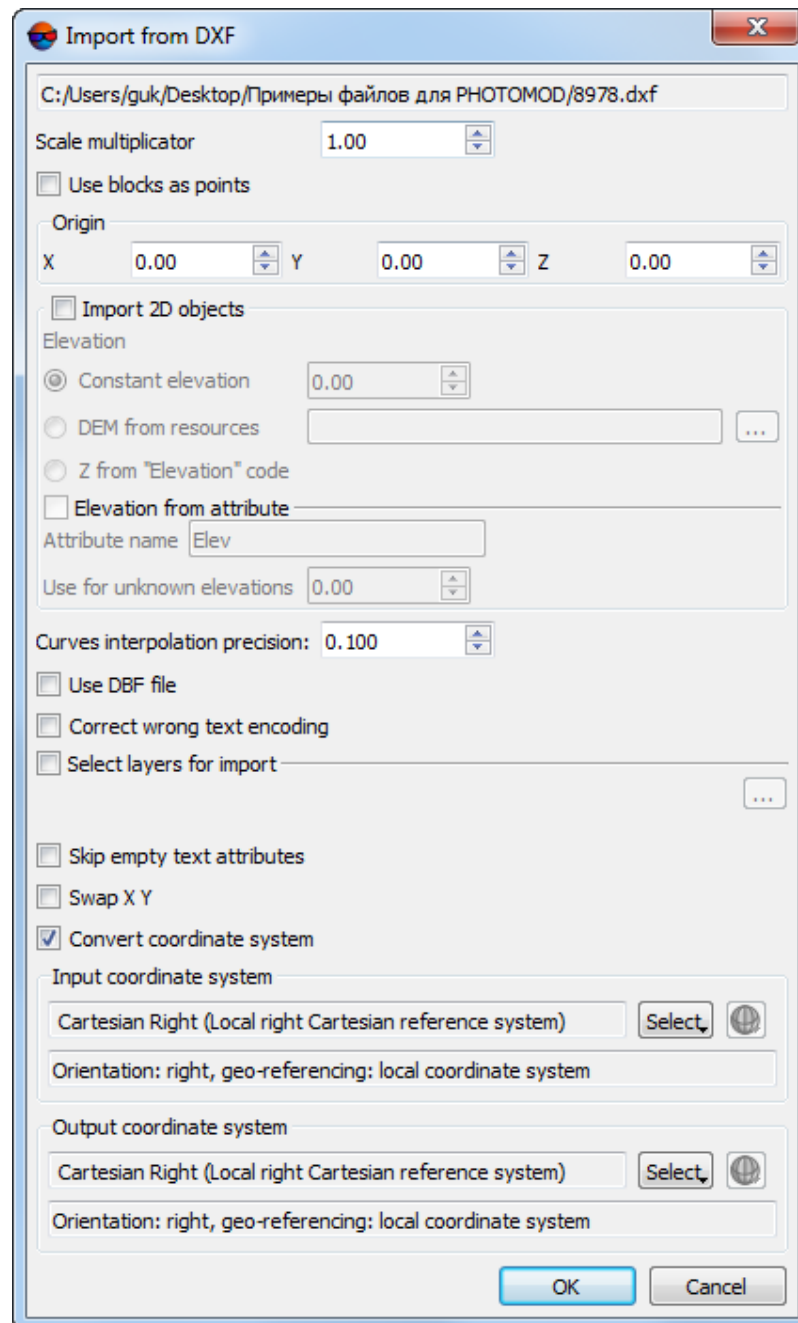



Fig. 222. Import from DXF

2. [optional] To multiply all coordinates of objects vertices during import specify the coefficient in the **Scale** field;
3. [optional] To import origin of *AutoCAD program* objects blocks as point objects, set the **Use blocks as points**;
4. In the **Point of origin** section specify origin of coordinate system;

5. [optional] To convert 2D objects from DXF file into 3D objects, set the **Import 2D objects** checkbox on. In the **Z for 2D objects** section define one of the calculation ways of Z coordinates of objects vertices:

- **Constant elevation** – allows to assign the same value of Z coordinate to all objects;
- **DEM from resources** – allows to select a resource with DEM containing Z values. Click the  button to choose file in active profile resources;
- **Z from “Elevation” code** – allows to import Z coordinate from “Elevation” code.

The **Elevation from attribute** checkbox allows to import Z coordinate from attribute, which name is specified in this field, its default value is *Elev*.

The **Use for unknown elevation** field allows to fill the empty elevations with a predetermined value.

6. [optional] To define import accuracy of objects, containing curve lines, specify the **Curves interpolation precision** parameter value.



After that the number of curve vertices may change.

7. [optional] To prevent creating text attributes with an empty value during import, set the **Do not create empty text attributes** checkbox on.



When the **Do not create empty text attributes** checkbox is on, in some cases a data loss may occur.

8. [optional] To define additional parameters set the **Use DBF file**, **Swap X Y** and **Transform reference system** checkboxes on (see [Section 10.5](#)).



If the last two checkboxes are set on, then when importing first XY-coordinates of points are swapped, then the system recalculates the coordinates.

9. [optional] To correct wrong import of text objects set the **Correct wrong text encoding** checkbox on.

10. [optional] To import a particular number of layers set the **Select layers for import** checkbox on and click the  button. The **Layers table** window is opened, where the list of layers to be imported is displayed.

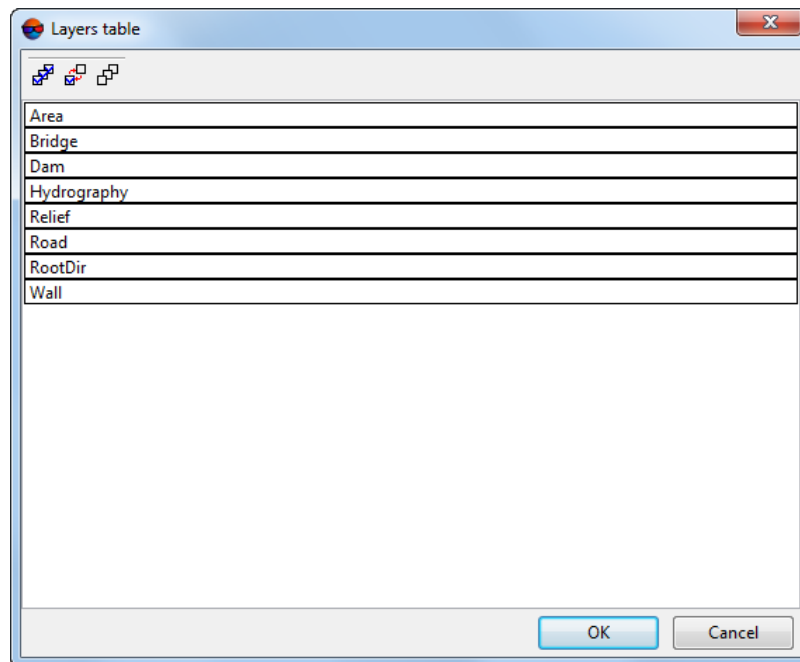



Fig. 223. Table of layers to be imported

Select layers in the table using one of the following ways:

- to import all layers, click the  button and click OK;
- to import not all layers, select them and click OK.



to invert layers selecting allows the  button, to unselect all layers – the  button.

11. Click OK to import.

13.6. Import from Generate

The system provides possibility of vector objects import from Generate format. Files with points have the *.gnp or *.pnt extension, files with polylines – *.gnl or *.lin. This format is used in the *ArcInfo* system.

In order to import vector objects from the Generate format perform the following actions:

1. Choose **Vectors** > **Import** > **Generate**. The **Import from Generate format** window opens.

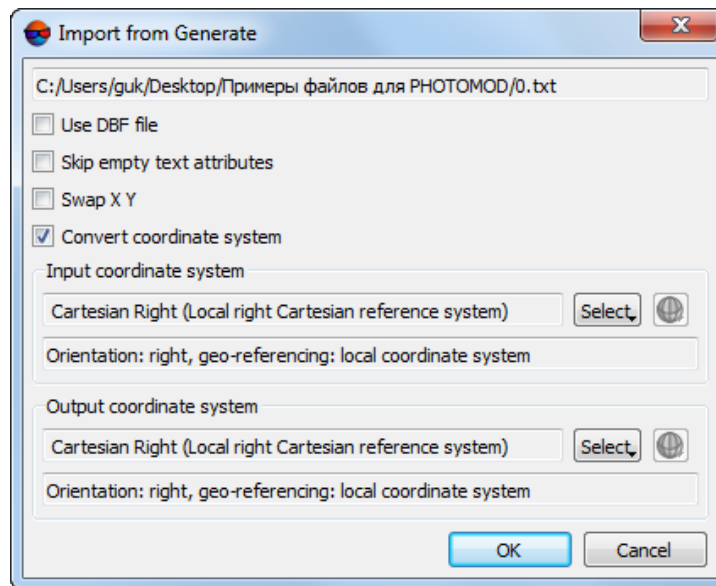

Fig. 224. Import from Generate

- [optional] To define additional parameters set the **Use DBF file**, **Swap X Y** and **Transform reference system** checkboxes on (see [Section 10.5](#)). If all checkboxes are set on, then when importing first XY-coordinates of points are swapped, then the system recalculates the coordinates.



If the **Swap X Y** checkbox is cleared, the vector objects will be imported in the right coordinate system. Otherwise, in the left one.

- [optional] To prevent creating text attributes with an empty value during import, set the **Do not create empty text attributes** checkbox on.



When the **Do not create empty text attributes** checkbox is on, in some cases a data loss may occur.

- Click OK to complete the import operation.

13.7. Import from ATLAS KLT

The system provides possibility to import vector objects from the ATLAS KLT format. Files of this format has the *.klt extension.

In order to import vector objects from the ATLAS KLT format perform the following actions:

- Choose **Vectors** > **Import** > **ATLAS KLT**. The **Import from ATLAS KLT format** window opens.

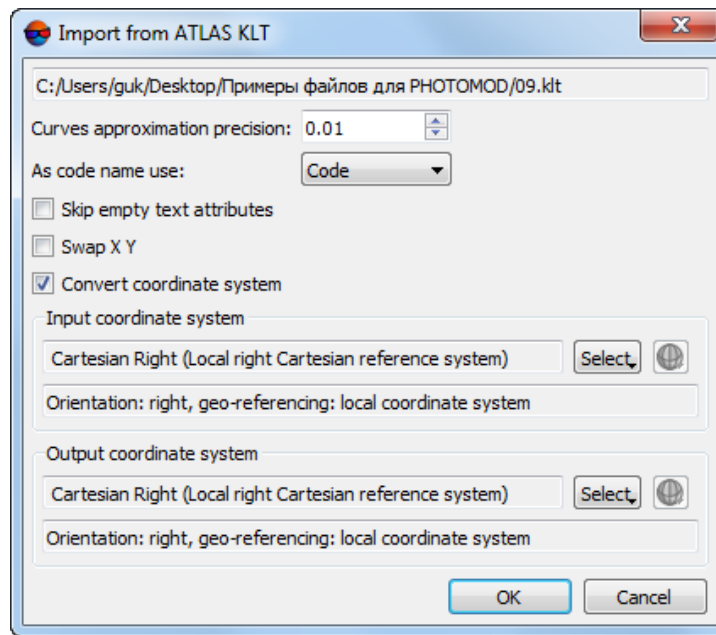

Fig. 225. Import from ATLAS KLT format

2. [optional] In order to change the number of vertices in a polyline approximating an arc, input the **Curves approximation precision** parameters value.



The higher the approximation precision, the more vertices in a polyline approximating the arc/circle.

3. Select in the **As a code name use**, list, which parameter is recorded as a code name when importing.
4. [optional] To prevent creating text attributes with an empty value during import, set the **Do not create empty text attributes** checkbox on.



When the **Do not create empty text attributes** checkbox is on, in some cases a data loss may occur.

5. [optional] In order to define standard parameters set the **Swap X Y** and **Convert coordinate system** checkboxes on (see [Section 10.5](#)). If all checkboxes are set on, then when importing first XY-coordinates of points are swapped, then the system recalculates the coordinates.



If the **Swap X Y** checkbox is cleared, the vector objects will be imported in the right coordinate system. Otherwise, in the left one.

6. Click OK to complete the import operation.

13.8. Import from KML / KMZ

The system provides possibility to import vector objects from the KML and KMZ formats. Files of this format have the *.kml (*.kmz) extension.



Import vector objects from KML (KMZ) format does not perform in projects in the local coordinate system.

In order to import vector objects from the KML (or KMZ) format perform the following actions:

1. Choose **Vectors** > **Import** > **KML, KMZ**. The **Import from KML / KMZ format** window opens.

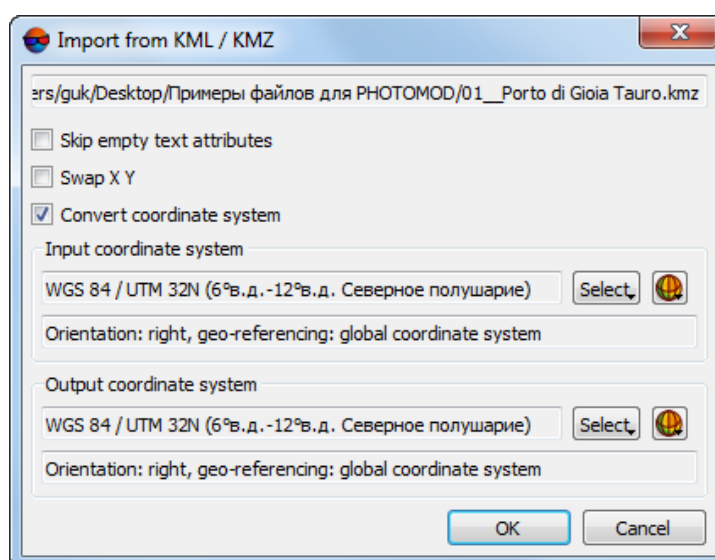

Fig. 226. Import from KML / KMZ format

2. [optional] To prevent creating text attributes with an empty value during import, set the **Do not create empty text attributes** checkbox on.



When the **Do not create empty text attributes** checkbox is on, in some cases a data loss may occur.

3. [optional] In order to define additional parameters set the **Swap X Y** and **Convert coordinate system** checkboxes on (see [Section 10.5](#)). If all checkboxes are set on, then when importing first XY-coordinates of points are swapped, then the system recalculates the coordinates.



If the **Swap X Y** checkbox is cleared, the vector objects will be imported in the right coordinate system. Otherwise, in the left one.

4. Click OK to complete the import operation.

13.9. Import from LAS

The system provides possibility to import laser scanning point cloud from LAS format. Files of this format has the *.las extension.

In order to import vector objects from the LAS format perform the following actions:

1. Choose **Vectors** > **Import** > **LAS**. The **Import from LAS format** window opens.

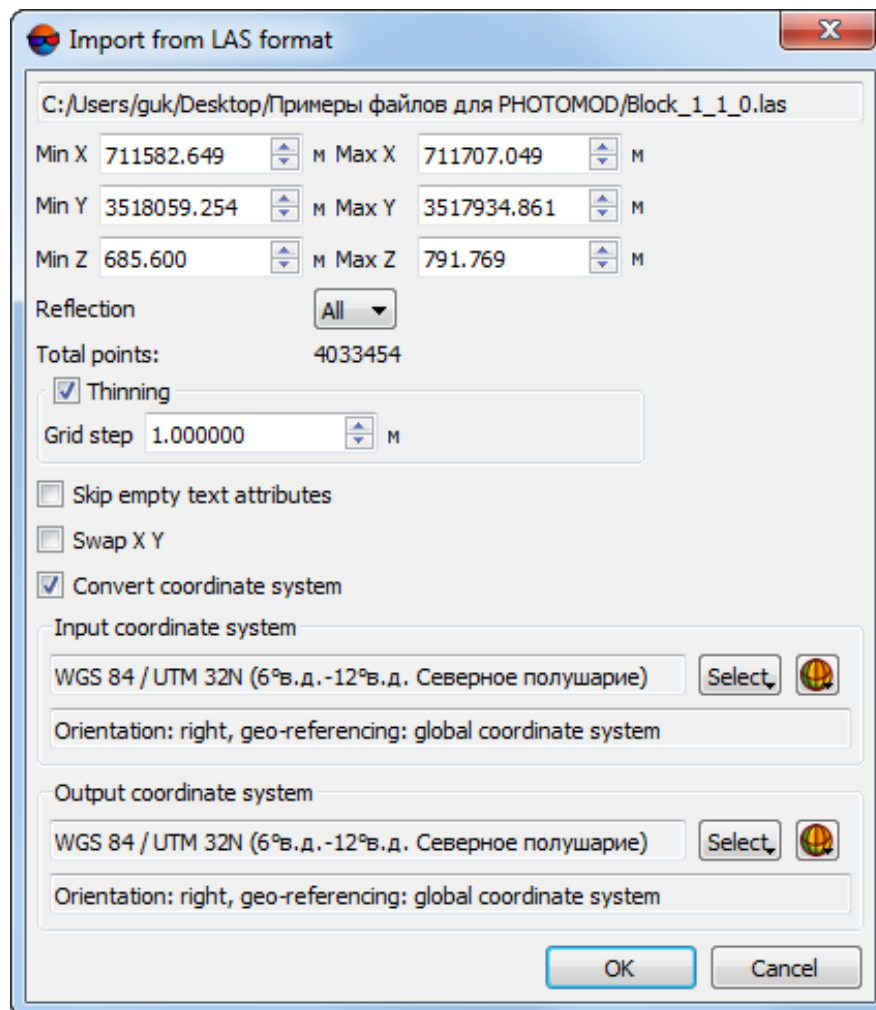

Fig. 227. Import from LAS format



In the **MinX**, **MinY**, **MinZ**, **MaxX**, **MaxY**, **MaxZ** fields the system displays coordinates range of points that are contained in imported LAS file.

2. In the **Reflection** list set a filter for the LIDAR points which are supposed to be imported in accordance with number of reflected pulses per one point (see the “[LIDAR Data processing](#)” User Manual);



The **total points** number to be imported according to the user settings is displayed in the appropriate field.

3. Input the **Thinning: grid step** value (in meters) to reduce the amount of data to be imported during the import process.



Point are thinned in such a way that the distance between them is not less than a predetermined grid step.

4. [optional] To prevent creating text attributes with an empty value during import, set the **Do not create empty text attributes** checkbox on.



When the **Do not create empty text attributes** checkbox is on, in some cases a data loss may occur.

5. [optional] In order to define additional parameters set the **Swap X Y** and **Convert coordinate system** checkboxes on (see [Section 10.5](#)). If all checkboxes are set on, then when importing first XY-coordinates of points are swapped, then the system recalculates the coordinates.



If the **Swap X Y** checkbox is cleared, the vector objects will be imported in the right coordinate system. Otherwise, in the left one.

6. Click OK to complete the import operation.

13.10. Import from LIG

The system provides possibility to import vector objects from the LIG format. Files of this format has the *.lig extension.

In order to import vector objects from the LIG format perform the following actions:

1. Choose **Vectors** › **Import** › **LIG**. The **Import from LIG format** window opens.

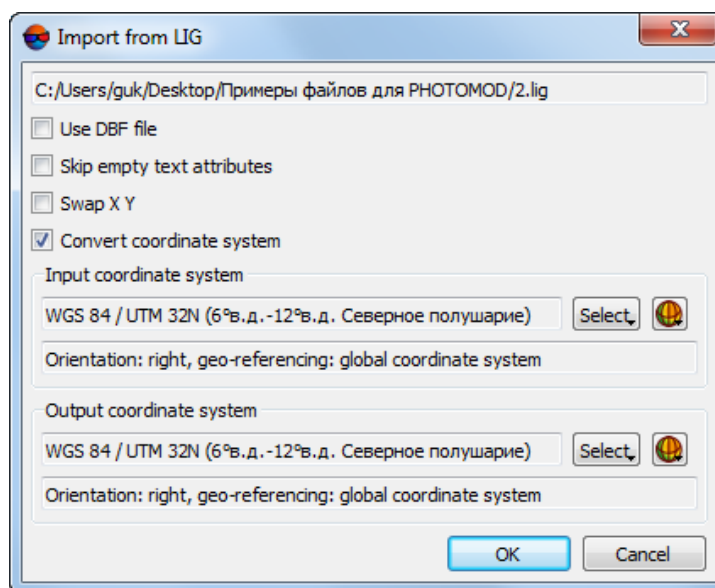

Fig. 228. Import from LIG format

- [optional] To define additional parameters set the **Use DBF file**, **Swap X Y** and **Transform reference system** checkboxes on (see [Section 10.5](#)). If all checkboxes are set on, then when importing first XY-coordinates of points are swapped, then the system recalculates the coordinates.



If the **Swap X Y** checkbox is cleared, the vector objects will be imported in the right coordinate system. Otherwise, in the left one.

- [optional] To prevent creating text attributes with an empty value during import, set the **Do not create empty text attributes** checkbox on.



When the **Do not create empty text attributes** checkbox is on, in some cases a data loss may occur.

- Click OK to complete the import operation.

13.11. Import from MIF / MID

The system provides possibility to import vector objects from the MIF/MID format. This is exchange format with `mif` extension, that is used in the *MapInfo* system.



When importing from MIF/MID format it is not allowed to use underscores in attributes names. Replace all underscore characters in attribute names with spaces.

In order to import vector objects from the MIF/MID format perform the following actions:

1. Choose **Vectors** > **Import** > **MIF/MID**. The **Import from MIF/MID format** window opens.

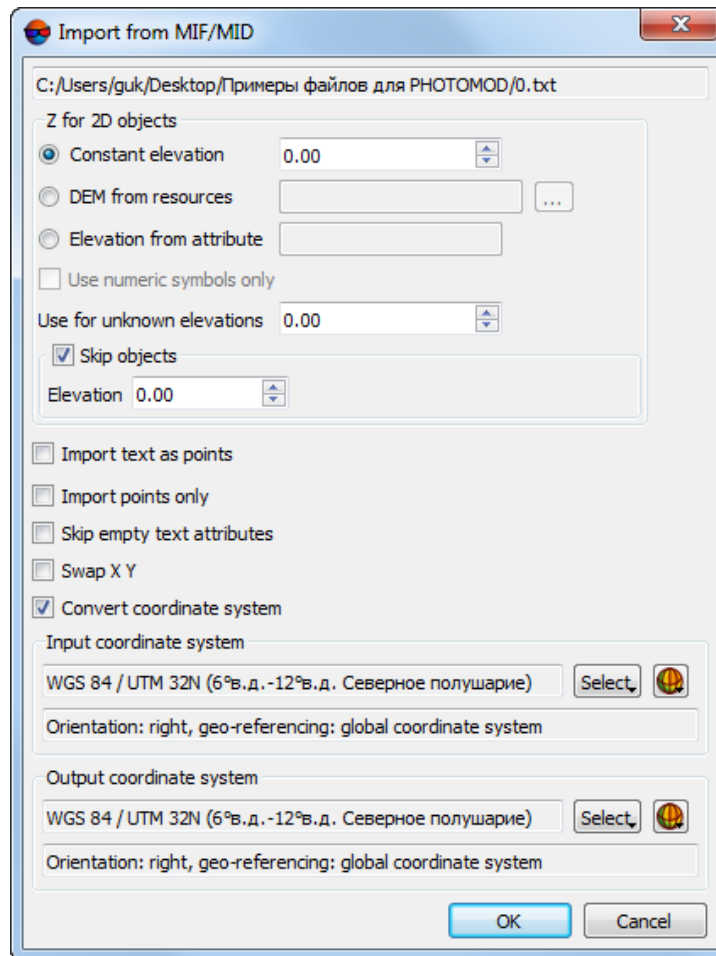



Fig. 229. Import from MIF/MID format

2. In the **Z for 2D objects** section define one of the calculation ways of Z coordinates of objects vertices:
 - **Constant elevation** – allows to assign the same value of Z coordinate to all objects;
 - **DEM from resources** – allows to select a resource with DEM containing Z values. To open necessary resource click the  button. To fill the empty DEM cells with a predetermined elevation values, change the **Use for unknown elevation** parameter value.
 - **Elevation from attribute** – allows to import Z coordinate from attribute, which name is specified in this field, its default value is Z. In order to remove all symbols

from an attribute except for digits, point, comma and minus, set the **Use numeric symbols only** checkbox;

3. [optional] In order to exclude objects with specified elevation, set the **Skip objects with elevation** checkbox on and input necessary value.
4. [optional] To convert text objects from MIF/MID file into point objects with label containing source object text, set the **Import text as points** checkbox on (see [Section 6.5](#)).
5. [optional] To split linear objects into separate points, set the **Import points only** checkbox on.
6. [optional] To prevent creating text attributes with an empty value during import, set the **Do not create empty text attributes** checkbox on.



When the **Do not create empty text attributes** checkbox is on, in some cases a data loss may occur.

7. [optional] In order to define standard parameters set the **Swap X Y** and **Convert coordinate system** checkboxes on (see [Section 10.5](#)). If all checkboxes are set on, then when importing first XY-coordinates of points are swapped, then the system recalculates the coordinates.



If the **Swap X Y** checkbox is cleared, the vector objects will be imported in the right coordinate system. Otherwise, in the left one.

8. Click OK to complete the import operation.

13.12. Import from Shape

The system provides possibility to import vector objects from the Shape format. This is exchange format with *.shp extension, that is used in *ArctInfo software* system.

The Shape format consists of three files with the same names and following extensions:

- *.shp – main file, that contains information about objects; one *Shapefile* stores objects of the only one type – points, polylines or polygons;
- *.shx – additional index file, that contains information about objects position in the main file; it is used to speed up access to the content of the *Shapefile*;
- *.dbf – additional file containing the table of DBF database (see [Section 13.14](#)).

In order to import vector objects from the Shape format perform the following actions:

1. Choose **Vectors** > **Import** > **Shape**. The **Import from Shape** window opens.

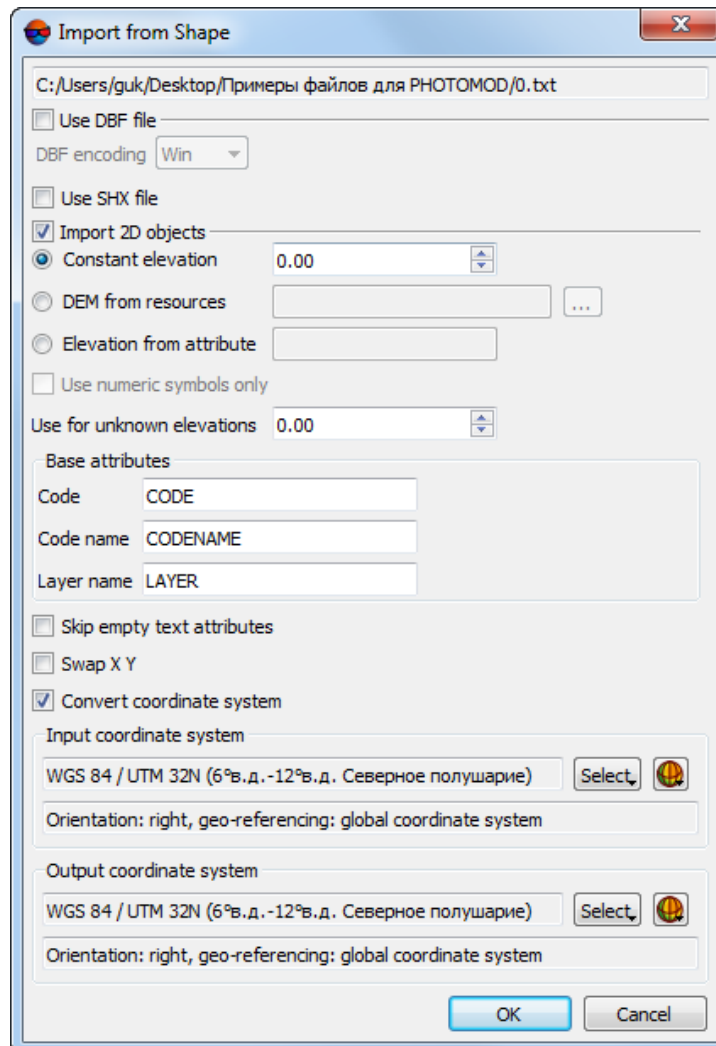

Fig. 230. Import from SHP format

2. [optional] To use file with attribute information about objects, and to assign vector objects to classifier, the **Use DBF file** checkbox is on by default (see [Section 13.14](#)).
 - Choose the DBF file encoding – **Win** or **UTF-8**.



The UTF-8 encoding may be necessary for proper export of Cyrillic symbols.

3. [optional] To use file with information about location of objects, stored in the file with *.shp extension, the **Use SHX file** checkbox is on by default.
4. [optional] To convert 2D objects from DXF file into 3D objects, set the **Import 2D objects** checkbox on.

In the **Z for 2D objects** section define one of the calculation ways of Z coordinates of objects vertices:

- **Constant elevation** – allows to assign the same value of Z coordinate to all objects;
- **DEM from resources** – allows to select a resource with DEM containing Z values. To open necessary resource click the  button. To fill the empty DEM cells with a predetermined elevation values, change the **Use for unknown elevation** parameter value;
- **Elevation from attribute** – allows to import Z coordinate from attribute, which name is specified in this field, its default value is Z. In order to remove all symbols from an attribute except for digits, point, comma and minus, set the **Use numeric symbols only** checkbox.

5. In the **Base attributes** section specify code names in the DBF file:

- **Code** – the *CODE* by default;
- **Code name** – *CODENAME* by default;
- **Layer name** – *LAYER* by default;

6. [optional] To prevent creating text attributes with an empty value during import, set the **Do not create empty text attributes** checkbox on.



When the **Do not create empty text attributes** checkbox is on, in some cases a data loss may occur.

7. [optional] In order to define standard parameters set the **Swap X Y** and **Convert coordinate system** checkboxes on (see [Section 10.5](#)). If all checkboxes are set on, then when importing first XY-coordinates of points are swapped, then the system recalculates the coordinates.



If the **Swap X Y** checkbox is cleared, the vector objects will be imported in the right coordinate system. Otherwise, in the left one.

8. Click OK to complete the import operation.

13.13. Import from Panorama

The system provides possibility of vector objects import from Panorama format. This is exchange format with *.sit and *.map extensions, that is used in *GIS Map* system.

In order to import vector objects from Panorama format perform the following actions:

1. Select **Vectors** › **Import** › **Panorama**. The **Import from Panorama format** window opens.

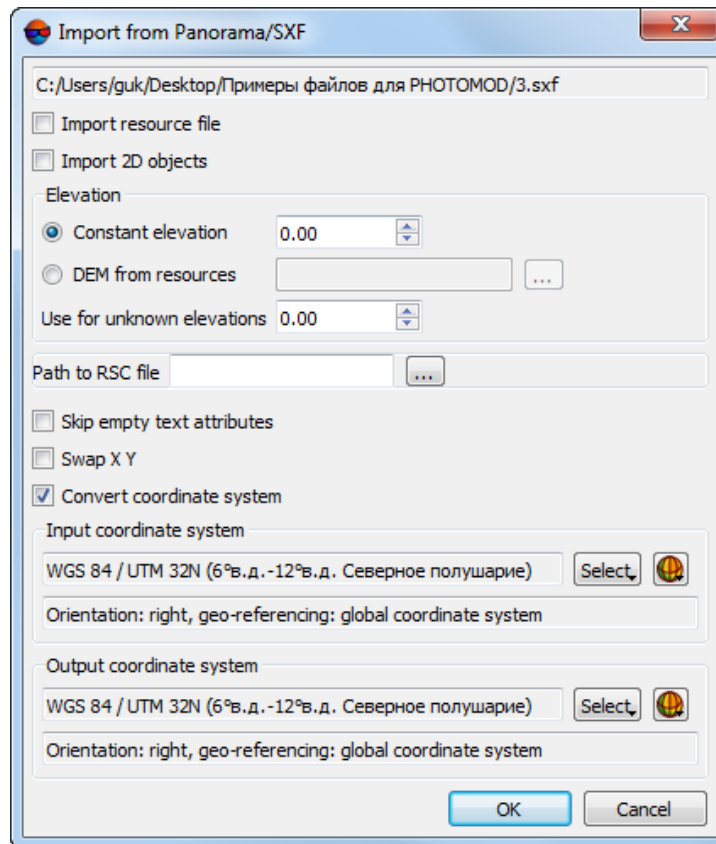



Fig. 231. Import from Panorama format

2. In order to convert the *Панорама* classifier into inner classifier of the system, the **Import classifier** checkbox is on by default (see [Section 6.4](#)).
3. [optional] To convert 2D objects from DXF file into 3D objects, set the **Import 2D objects** checkbox on. In the **Z for 2D objects** section define one of the calculation ways of Z coordinates of objects vertices:
 - **Constant elevation** – allows to assign the same value of Z coordinate to all objects;
 - **DEM from resources** – allows to select a resource with DEM containing Z values. To open necessary resource click the  button. To fill the empty DEM cells with a predetermined elevation values, change the **Use for unknown elevation** parameter value. The default value is 0.0.
4. [optional] To prevent creating text attributes with an empty value during import, set the **Do not create empty text attributes** checkbox on.



When the **Do not create empty text attributes** checkbox is on, in some cases a data loss may occur.

- [optional] In order to define standard parameters set the **Swap X Y** and **Convert coordinate system** checkboxes on (see [Section 10.5](#)). If all checkboxes are set on, then when importing first XY-coordinates of points are swapped, then the system recalculates the coordinates.



If the **Swap X Y** checkbox is cleared, the vector objects will be imported in the right coordinate system. Otherwise, in the left one.

- Click OK to complete the import operation.

The system provides possibility to import just point objects and linear object vertices without attribute from Panorama format.

Perform the following actions to do this:

- Choose **Vectors > Import > Panorama (points only)**. The **Import from Panorama format** window opens.

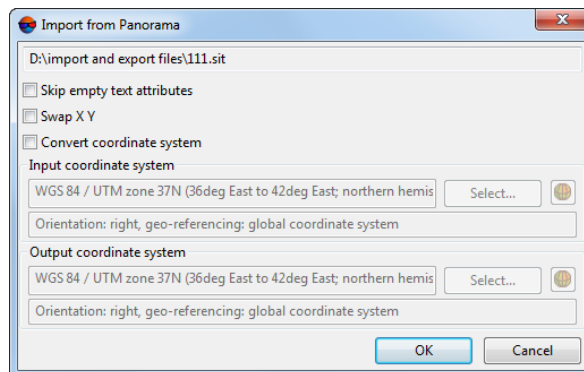

Fig. 232. Import points from Panorama format

- [optional] To prevent creating text attributes with an empty value during import, set the **Do not create empty text attributes** checkbox on.



When the **Do not create empty text attributes** checkbox is on, in some cases a data loss may occur.

- [optional] In order to define additional parameters set the **Swap X Y** and **Convert coordinate system** checkboxes on (see [Section 10.5](#)). If all checkboxes are set on, then when importing first XY-coordinates of points are swapped, then the system recalculates the coordinates.



If the **Swap X Y** checkbox is cleared, the vector objects will be imported in the right coordinate system. Otherwise, in the left one.

4. Click OK to complete the import operation.

13.14. Using DBF file

The system allows to use DBF file if it is near to imported file. This is a file with the *.dbf extension contains dBASE database table and is used as a file with attribute information about objects, as well as for assigning vector objects to classifier.

Set the **Use DBF** checkbox on in the import settings window to use DBF file.

The database fields contain attribute information. In the first four fields DBF file stores the following information:

- *NAME* – a unique object name;
- *CODE* – a code in classifier, to which the object is assigned;
- *CODENAME* – a code name in classifier, to which the object is assigned;
- *LAYER* – the layer name in the classifier, in which there is the object's code.

Starting with the fifth field in the file are stored both basic and additional attributes of vector objects.

When importing objects with the classifier from external exchange formats the objects are attached to the current codes of [classifier](#). To do this the system uses the information stored in the main importing file or in DBF file. Objects are assigned to classifier during import in the following way:

1. From the main importing file or from DBF file the system reads code name, code, object type (point, polyline, polygon) and layer name.
2. The system checks a presence of code in loaded classifier. If the code is present in the classifier, the object is assigned to it automatically. If there is no such code in the classifier, the system creates a new layer and imported objects are assigned to it.

13.15. Batch import

The system allows to perform import of multiple files with vector objects of any format.

To perform import of triangulation points catalogue perform the following actions:

1. Choose **Vectors** > **Import** > **necessary_format**. The system opens the window used to select files to be imported.
2. To choose files for import, click on them while the **Shift** key pressed.
3. Click the **Open** button. The import parameters window opens (more details on the import options see in the relevant paragraphs of this section).
4. Setup import parameters and click OK. The **Loading** window opens.

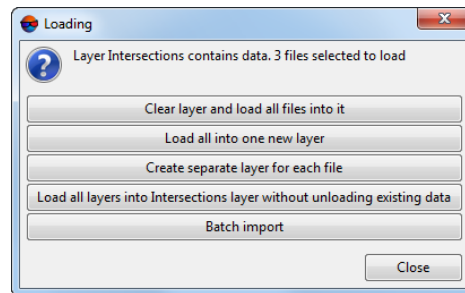

Fig. 233. Ways of multiple file loading

5. Select one of the following ways of imported layers loading:
 - **Clear layer and load all files into it** – vector data of active layer is replaced by data from loading layers;
 - **Load all into one new layer** – vector data is loaded to a single new vector layer;
 - **Create separate layer for each file** – vector data of each file are loaded to separate layers;
 - **Load all layers into Vectors without unloading existing data** – during loading vector data is added to objects of active vector layer.
 - **Batch import** – vector data is imported to system's internal format and are saved to the selected folder in active profile resources. At that the data are not loaded in the project and new layers are not created.



If there are no loaded layers in the project, the **Clear layer and load all files into it** and **Load all layers into Vectors without unloading existing data** loading options does not display.

13.16. Import from GDAL formats

The system provides possibility to import vector objects from formats supported by GDAL library. To perform such import choose **Vectors** > **Import** > **GDAL formats**.

13.16.1. Import from GeoPDF

The system provides possibility to import vector objects from the GeoPDF format (if such data is available in current GeoPDF file). Files of this format has the *.pdf extension.



The system allows to load GeoPDF file as a georeferenced raster file (see the “Georeferenced external data” chapter of the “[Aerial triangulation](#)” User Manual).

In order to import vector objects from the GeoPDF format perform the following actions:

1. **Create** empty vector layer with classifier.
2. Choose **Vectors** › **Import** › **GDAL formats...**. The **Import from GDAL formats** window opens.

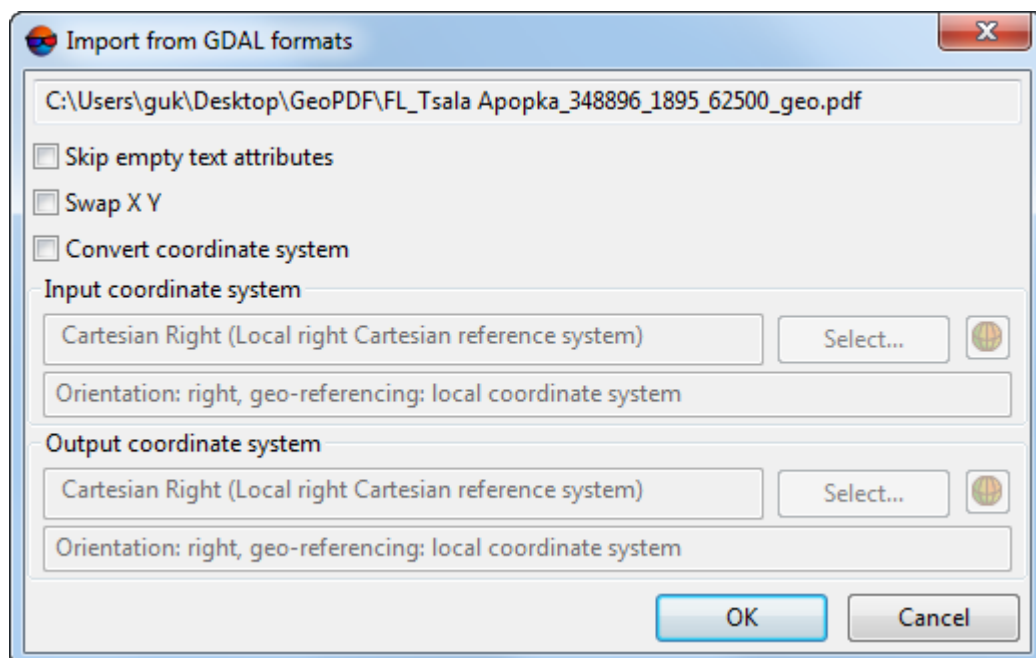

Fig. 234. Import from GeoPDF

3. [optional] In order to define standard parameters set the **Swap X Y** and **Convert coordinate system** checkboxes on (see [Section 10.5](#)). If all checkboxes are set on, then when importing first XY-coordinates of points are swapped, then the system recalculates the coordinates.



If the **Swap X Y** checkbox is cleared, the vector objects will be imported in the right coordinate system. Otherwise, in the left one.

- [optional] To prevent creating text attributes without value during import, set the **Do not create empty text attributes** checkbox on.



When the **Do not create empty text attributes** checkbox is on, in some cases a data loss may occur.

- Click OK to complete the import operation.

14. Export of vector objects

14.1. Export to ASCII

The system provides possibility of export to ASCII format. In ASCII format, each vector object is referred to as a sequence of vertices with three-dimensional coordinates. A description of the file format see in the [Section 13.1](#).

In order to export vector objects to ASCII format perform the following actions:

- Select **Vectors** > **Export** > **ASCII**. The **Export to ASCII** window opens.

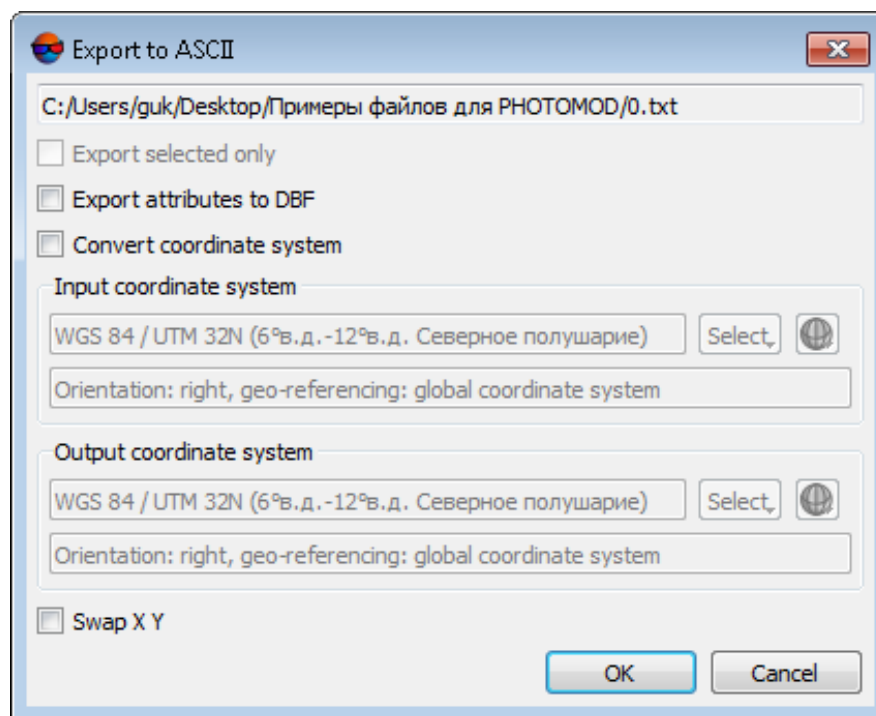

Fig. 235. Export to ASCII format

- [optional] In order to export just selected points, set the **Export selected only** checkbox.

3. [optional] To create file with attribute information about objects, and to assign vector objects to classifier, set the **Export attributes to DBF file** checkbox on.
4. [optional] In order to define standard parameters set the **Swap X Y** and **Convert coordinate system** checkboxes on (see [Section 10.5](#)).



If the **Swap X Y** checkbox is set off, the vector objects will be exported in the right coordinate system. Otherwise, in the left one.

5. Click OK to complete the export operation.

14.2. Export to ASCII-A

The system provides possibility of vector objects export to ASCII-A format. ASCII-A format contains information about coordinates of vector objects vertices, as well as information about object type, layer number, attributes name and value. A description of the file format see in the [Section 13.2](#).

In order to export vector objects to ASCII-A format perform the following actions:

1. Choose **Vectors > Export > ASCII-A**. The **Export to ASCII-A format** window opens.

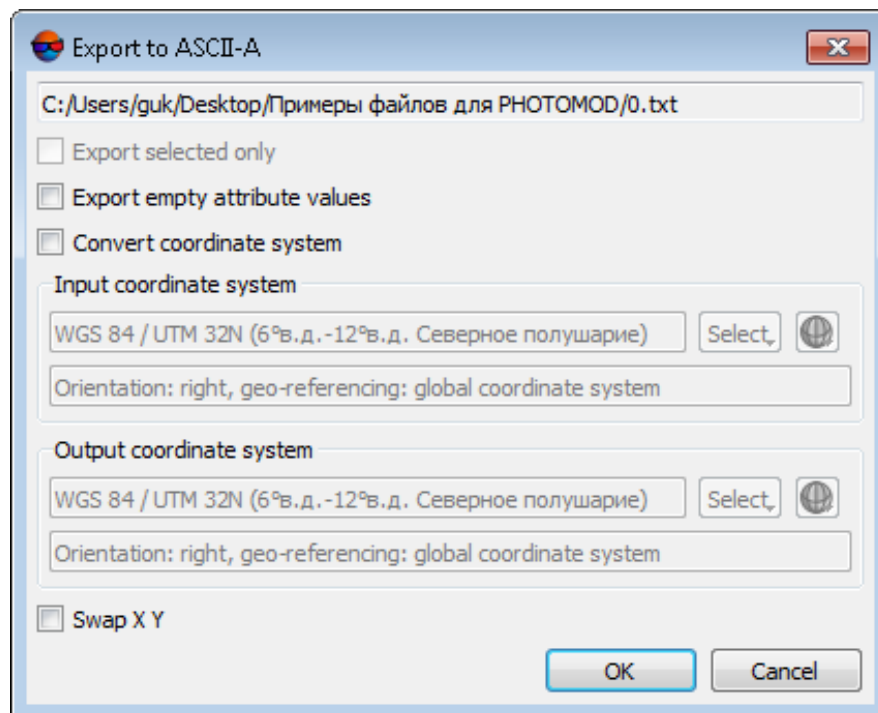

Fig. 236. Export to ASCII-A format

2. [optional] In order to export just selected points, set the **Export selected only** checkbox.

3. [optional] In order to export data without attribute information, set the **Export empty attribute values** checkbox.
4. [optional] In order to define standard parameters set the **Swap X Y** and **Convert coordinate system** checkboxes on (see [Section 10.5](#)).



If the **Swap X Y** checkbox is set off, the vector objects will be exported in the right coordinate system. Otherwise, in the left one.

5. Click OK to complete the export operation.

14.3. Export to CSV

The system provides possibility of export to CSV format. CSV format is exchange text format with csv extension, which is supported by major applications in different industries. It is used as exchange format when special geospatial data formats are not applicable for some reason. In particular, CSV format is often used the exchange data about orthomosaic splitting into sheets.

In order to export vector objects to CSV format perform the following actions:

1. Select **Vectors** › **Export** › **CSV**. The **Export to CSV** window opens.

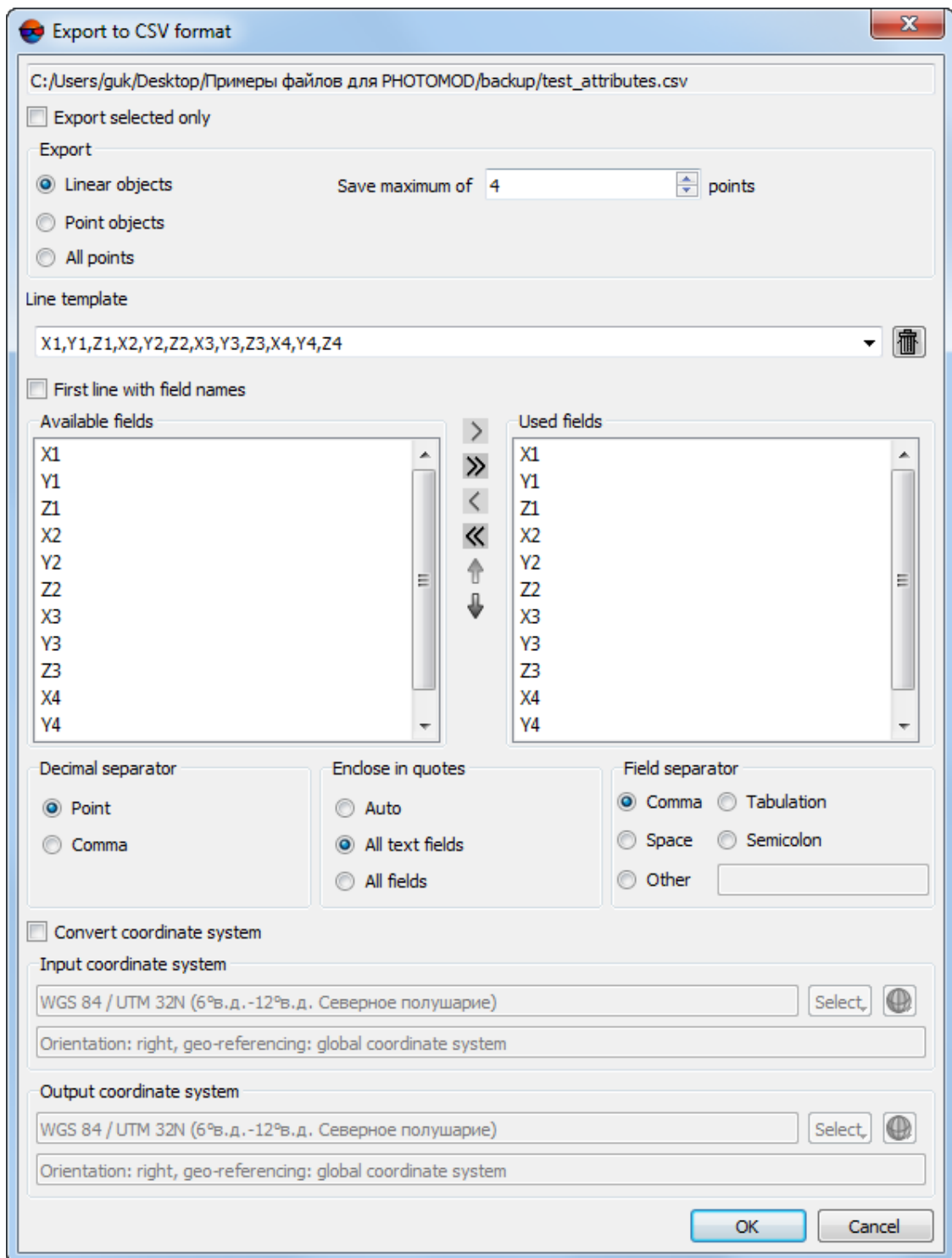



Fig. 237. Export to CSV format

2. [optional] In order to export selected points only, set the **Export selected only** checkbox on.

3. [optional] In order to export one type of objects, in the **Export** section choose objects type:
 - **Linear objects** – only polylines is exported. In the **Save maximum of .. points** field is defined maximum number of vertices of polyline for export. The other vertices are not export and polyline is cutting out;
 - **Point objects** – only points is exported;
 - **All points** – both points and vertices are exported.
4. The **Line template** field displays the list of fields of each line of CSV-file. Define the following additional parameters of data in file:









The  button allows to clear the **Line template** field.

- **First line with field names** – allows to add **Line template** in the first line of file;
- **Maximum decimal places** – allows to specify number of decimal places in points coordinates.



Line template could be specified manually or with **Available/Used fields** lists.

5. In the **Available fields** list are displayed names of fields could be used as **line template** for export. In the **Used fields** is displayed list of fields that are used as **Line template**. Prepare template with the following buttons:
 -  – allows to add selected **Available field** to the **Used fields** list (add to the template);
 -  – allows to add all **Available fields** to a line template;
 -  – allows to remove selected field name from the **Used fields** list;
 -  – allows to remove all fields names from this list;
 -  – allows to move down field selected in the **Used fields** list;
 -  – allows to move up field selected in the **Used fields** list.
6. In the **Decimal separator** section choose, point or comma to be used to separate coordinates.
7. [optional] In order to limit required parts of exported list of coordinates by quotes, in the **Enclose in quotes** section choose one of the following options:

- **Auto** – fields limit by quotes automatically;
 - **All text fields** – only text fields are limited by quotes;
 - **All fields** – allows to limit by quotes each field, which is located in the exported file.
8. In the **Field separator** section choose, what is used to separate fields: **comma**, **space**, **tab**, **semicolon** or **other**.
-  If a **comma** is used as *field separator*, it is strongly not recommended for the **Decimal separator** use **point or comma**, since objects will export incorrect.
9. [optional] To define standard parameters set the **Transform reference system** checkbox on (see [Section 10.5.2](#)).
10. Click OK to complete the export operation.

14.4. Export to DGN

The system provides possibility of export to DGN V7 format (another names are *ISFF DGN/Intergraph DGN*). This is exchange format with *.dgn extension, that is used in *MicroStation 7*.



The DGN V8 format, that is used in the *MicroStation 8* and later versions is not supported. In this case to perform data exchange it is necessary in *MicroStation* to convert DGN file to V7 format. Exported file in DGN V7 format could be opened in any *MicroStation* version, however, format features imposes restrictions on the completeness of exported data.

The file of this format contains code, code name, object type, and object attributes. Coordinates in DGN format are presented as main units *Position Units* in the range from 0 to $4 \cdot 10^9$. For floating-point numbers the additional units *Sub Units (SU)* and *Master Units (MU)* are used.



The ratio of measurement units:

$$1 \text{ SU} = N \text{ Pos.units}$$

$$1 \text{ MU} = M \text{ SU} ,$$

where N and M -- integer numbers, stored as constants in DGN file.

In order to export vector objects to DGN format perform the following actions:

1. Select **Vectors** > **Export** > **DGN**. The **Export to DGN** window opens.

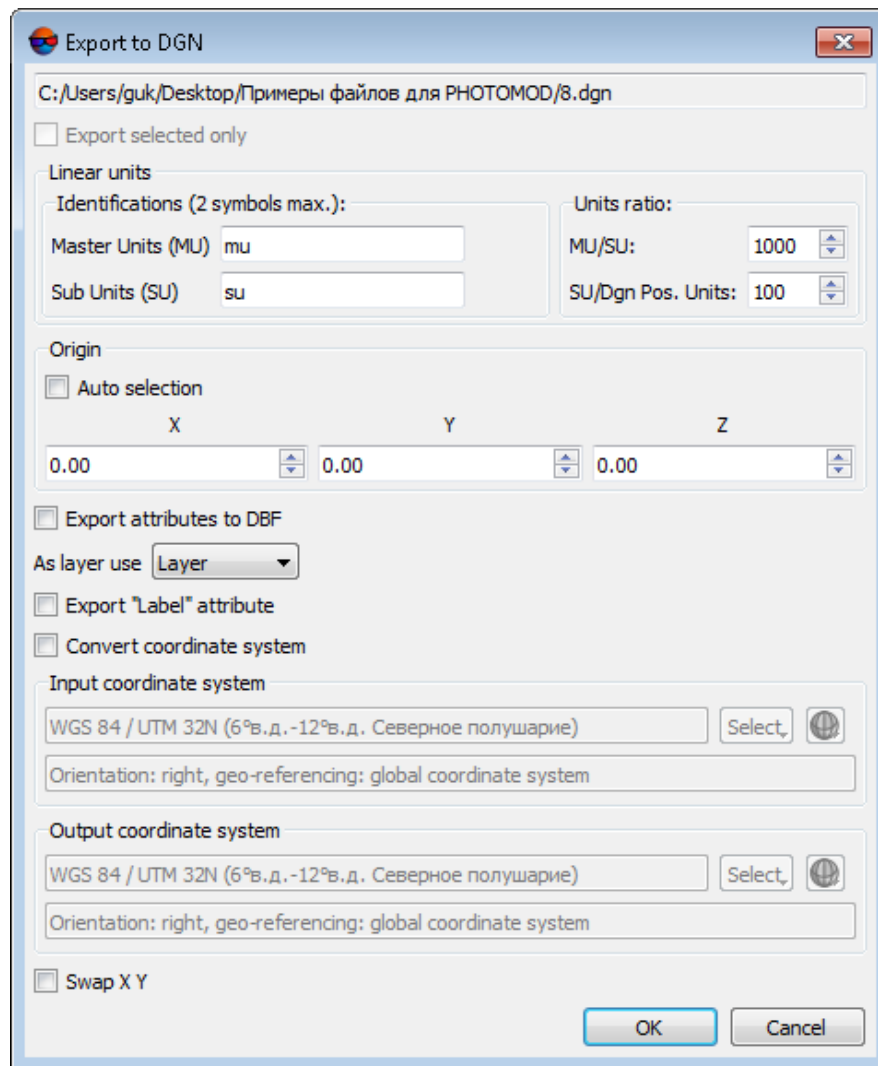

Fig. 238. Export to DGN format

2. [optional] In order to export just selected points, set the **Export selected only** checkbox.
3. [optional] To rename *Sub Units (SU)* and *Master Units (MU)*, in the **Linear units** section input notations containing two symbols. To change the ratio of units, change the **MU/SU** or **SU/DGN Pos. parameters Units**.
4. In the **Point of origin** section specify origin coordinates. The **Auto selection** checkbox allows to define coordinate system origin as as the center of parallelepiped circumscribing all available objects.
5. [optional] To create file with attribute information about objects, and to assign vector objects to classifier, set the **Export attributes to DBF file** checkbox on.

6. In order to specify what to assign vector objects after export, select the **As layer use:** parameter in the list.



By default the system assigns objects using layer name. After that the system creates file with *.lvl extension, which contains selected layers names.



The system allows to use assignment by object code or by the code name.

7. [optional] In order to export special objects labels (see [Section 6.5](#)), set the **Export Label attribute** checkbox.

8. [optional] To define standard parameters set the **Swap X Y** and **Transform reference system** checkboxes on (see [Section 10.5](#)).



If the **Swap X Y** checkbox is set off, the vector objects will be exported in the right coordinate system. Otherwise, in the left one.

9. Click OK to complete the export operation.

14.5. Export to DXF

The system provides possibility of export to DXF format. This is exchange format with *.dxf extension, that is used in the *AutoCAD program*.



The DXF format, that is used in the *AutoCAD R15* and later versions is not supported. In this case to perform data exchange it is necessary in *AutoCAD program* to convert DXF file to R14 format. During vector objects export the system also preserves the selected line style used when exported DXF file is opened in the *AutoCAD program*.



Vector objects are exported as 3D-polylines by default. For the convenience of AutoCad users, the system also provides for the export of vector objects as 2D-polylines (see **Save as 2D** checkbox below).



When exporting vector objects as 2D polylines, the system allows one to **export Z to “Elevation” attribute**. If the appropriate checkbox is set, a value of the first polyline/polygon vertex elevation is exported into the Elevation attribute. Thus, this function is for the export of vector object elevation values in case when all their vertices have the same elevation, e.g. contours.

In order to export vector objects to DXF format perform the following actions:

1. Load a vector layer with points.
2. Select **Vectors > Export > DXF**. The **Export to DXF format** window opens.

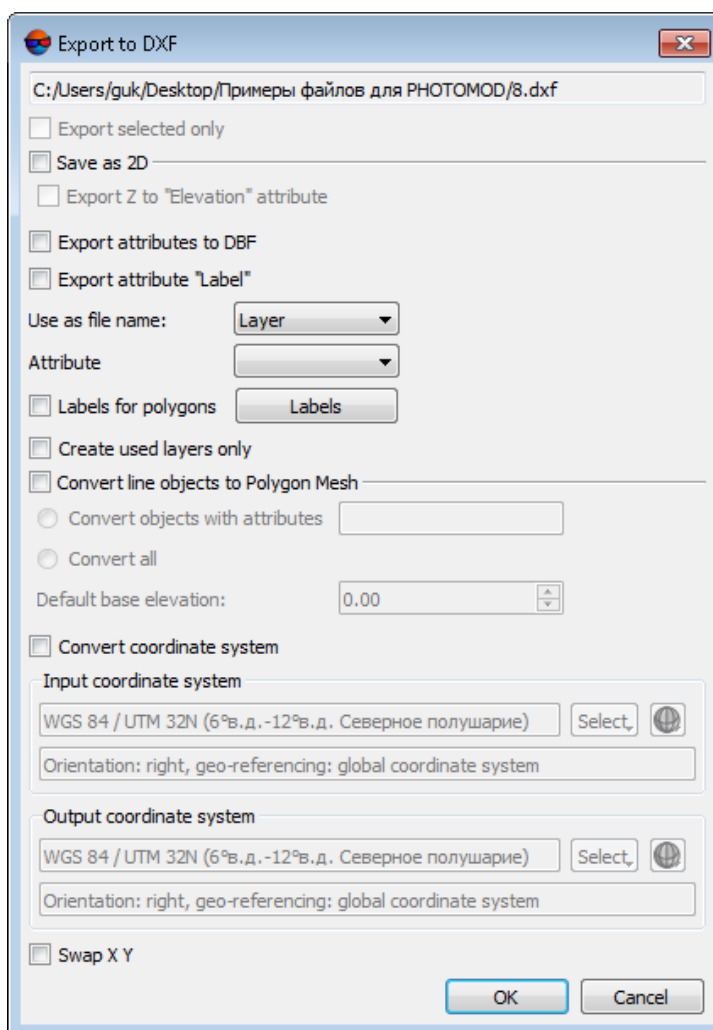

Fig. 239. Export to DXF format

3. Specify the following parameters of export:

- **Export selected only** – allows to export only selected object from active layer;
- **Export attributes to DBF** – allows to create file with with attribute information about objects, as well as for assigning vector objects to classifier;
- **Export attribute “Label”** – allows to export special object labels (see [Section 6.5](#));
- **Use as layer** – allows to choose what to assign vector objects after export;



By default the system assigns objects using layer name. After that the system creates file with *.lvl extension, which contains selected layers names.



The system allows to use assignment by object code or by the code name. When vector objects are assigned by attribute value, select the *Label* name in the **Attribute** list.

- **Create used layers only** – allows to export only classifier layers with vector objects;
- **Labels for polygons** – allows to export labels for polygons in a separate layer. Click the **Labels** button to specify parameters of labels export.

The **Labels for polygons** window opens.

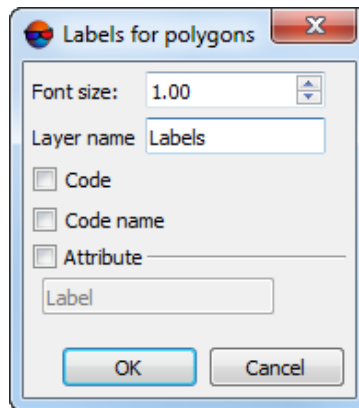

Fig. 240. Parameters polygon labels

Define the following parameters:

- **Font size** of labels;
 - **Layer name** – name of layer with labels;
 - **Code, Code name** or **Attribute** – allows to specify layer name (see [Section 7.3.1](#)).
4. [optional] To convert linear objects to polyhedral object (see example below) set the **Convert linear objects to Polygon Mesh** checkbox on and specify, what objects to convert:
 - **Convert objects with attributes** – used to convert linear objects with attribute;
 - **Convert all** – used to convert all linear objects; to set the orthogonal projection of a linear object on a horizontal plane, change the **Default base elevation**.
 5. [Optional] To export vector objects without elevations, set the **Save as 2D** checkbox.
 6. [optional] In order to define additional parameters set the **Swap X Y** and **Convert coordinate system** checkboxes on (see [Section 10.5](#)).
 7. Click OK to complete the export operation.

There is an example of export vector objects to DXF format with converting them to a polyhedral object.

1. Load a *Roofs* layer with vector objects (roofs) to export in DXF format with converting on polyhedral object.

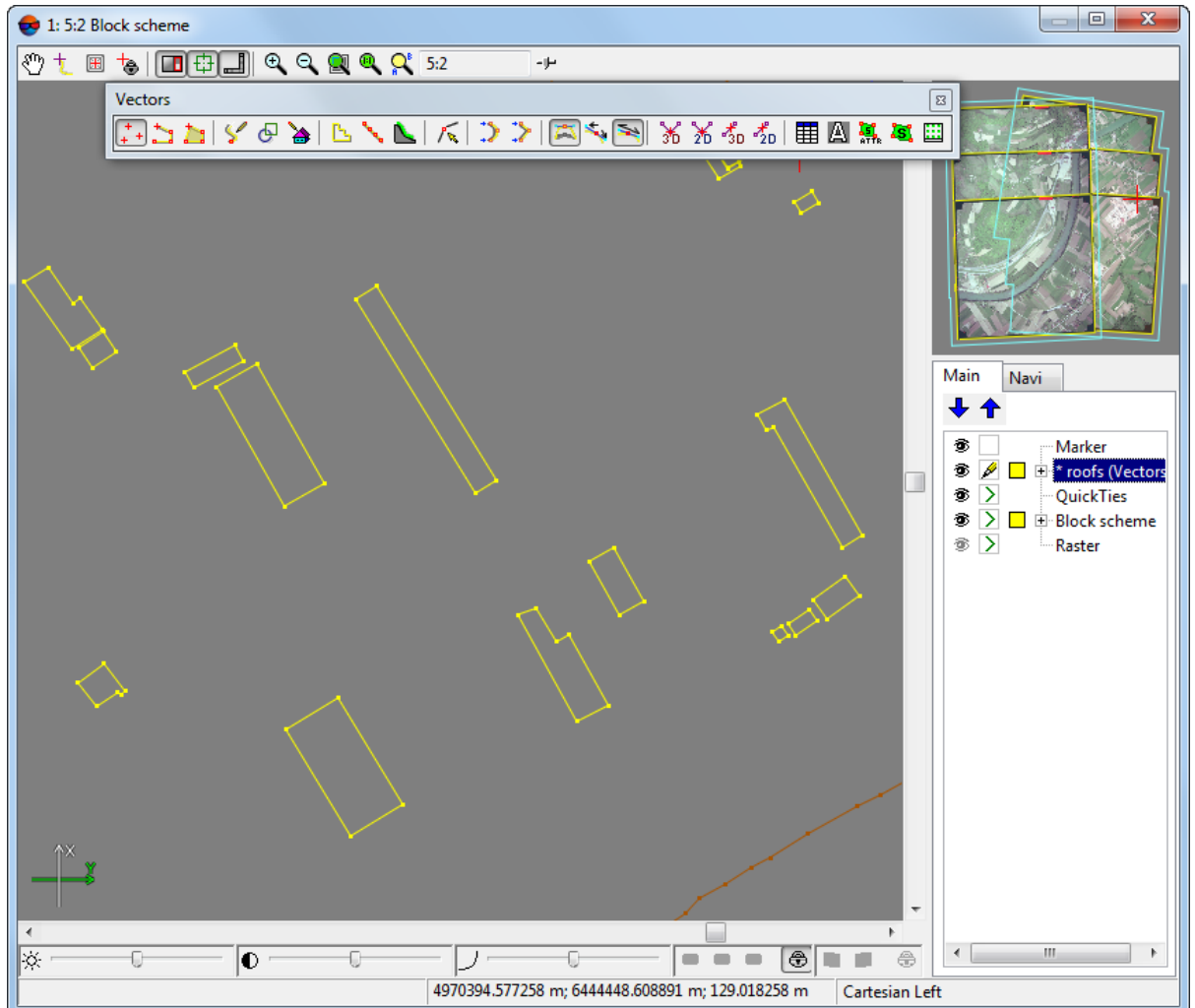

Fig. 241. Source vector layer

2. In the **Export to DXF** window set the set the **Convert linear objects to Polygon Mesh** checkbox on and export objects to a DXF file.

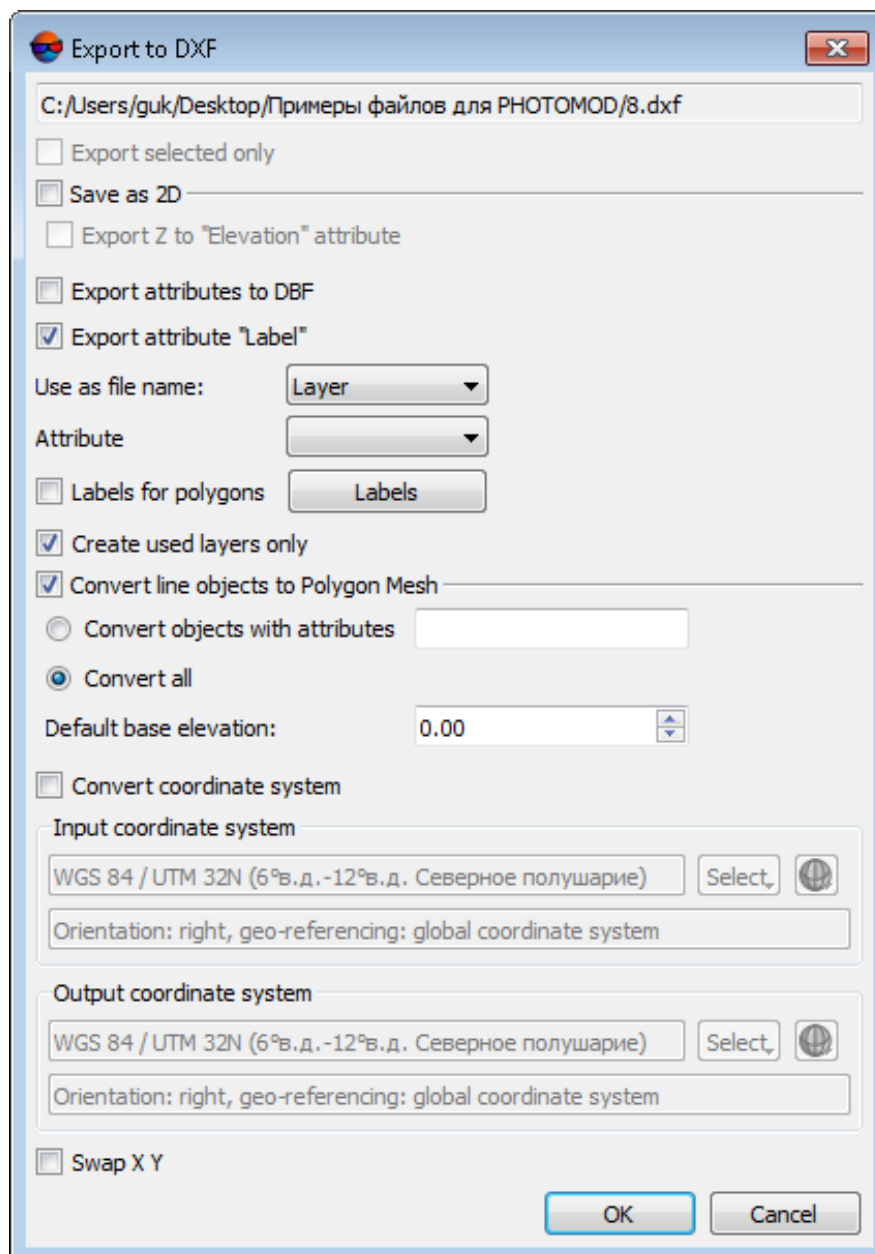

Fig. 242. Parameters of export to DXF format

3. Open exported file in the *Autodesk* program. Roofs are displayed as polyhedral objects.

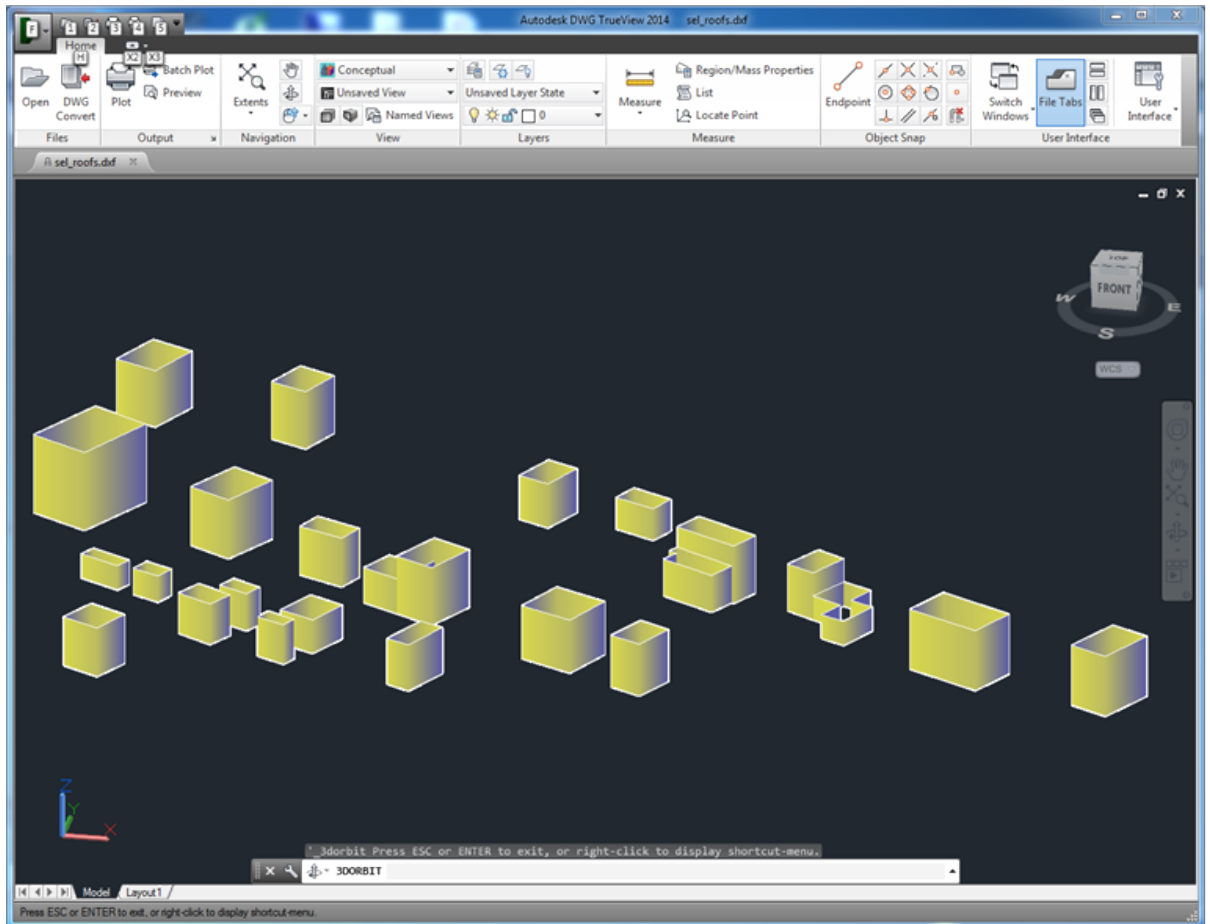

Fig. 243. Roofs, displayed as polyhedral objects

The system also provides possibility of batch vector objects export to DXF format. Batch export is used to export classifier layer to separate files.

Perform the following actions to do this:

1. Open a layer with classifier.
2. Select **Vectors** › **Batch export by classifier** › **DXF**. The **Browse for folder** window opens.
3. Select folder to export files.
4. Click OK. The **Export to DXF** window opens.

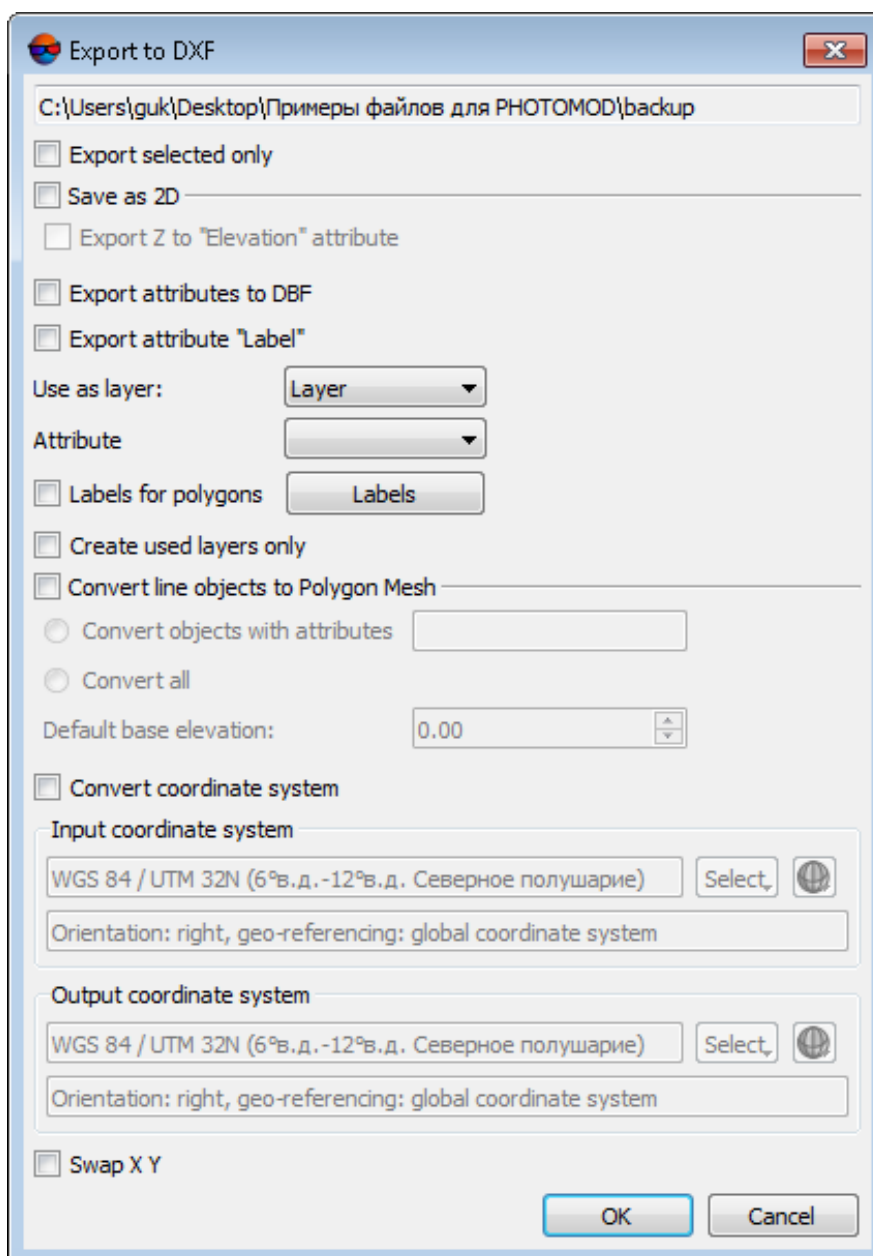

Fig. 244. Batch export to DXF format

5. Choose in the **As file name use** list classifier parameter, by which vector data divides to files and names assign to these files: **Layer**, **Code Code name** or **Attribute value**.
6. Configure the rest parameters of export in the same way as for usual export to DXF format.
7. Click OK. In chosen path are created files, each of them contains data of only selected classifier layer (or parameter).

14.6. Export to Generate format

The system provides possibility of export to Generate format. This format is used in *ArcInfo* softwaresystem. Files with points have the *.gnp or *.pnt extension, files with polylines – *.gnl or *.lin.

During export to *Arc Generate* integer index is assigned to each object. If the layer with classifier is exported, the object code, which is an integer is used as this index. Otherwise, the object is assigned an index equal to the maximum value of all already used codes plus 1.

In order to export vector objects to Generate format perform the following actions:

1. Select **Vectors** > **Export** > **Generate**. The **Export to Generate** window opens.

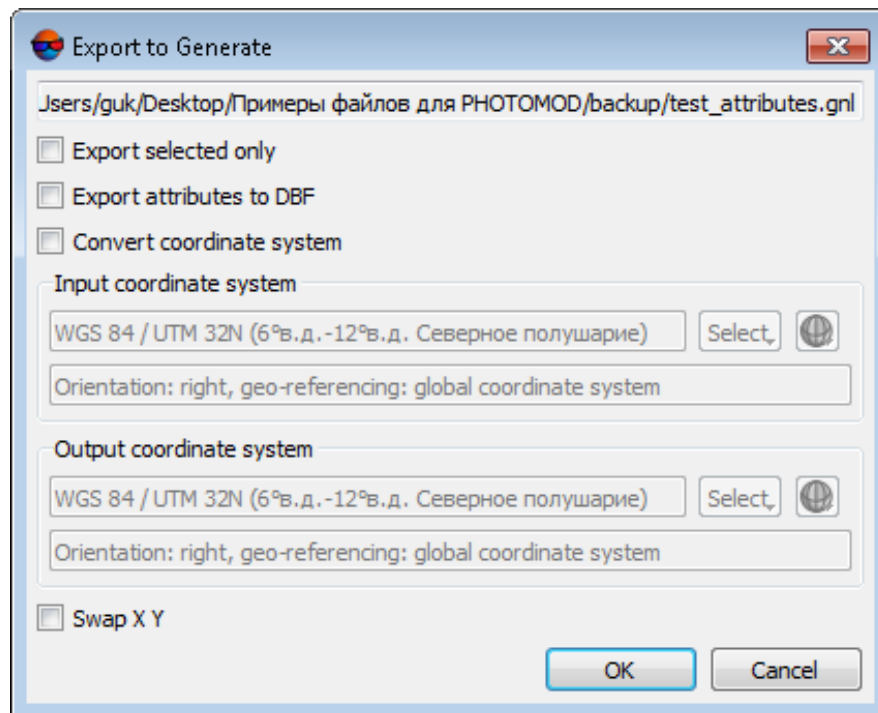

Fig. 245. Export to Generate format

2. [optional] In order to export just selected points, set the **Export selected only** checkbox.
3. [optional] To create file with attribute information about objects, and to assign vector objects to classifier, set the **Export attributes to DBF file** checkbox on.
4. [optional] In order to define standard parameters set the **Swap X Y** and **Convert coordinate system** checkboxes on (see [Section 10.5](#)).



If the **Swap X Y** checkbox is set off, the vector objects will be exported in the right coordinate system. Otherwise, in the left one.

- Click OK to complete the export operation.

14.7. Export to ATLAS KLT format

The system provides possibility of vector objects export to ATLAS KLT format.

Files of this format has the *.klt extension.

In order to export vector objects to ATLAS KLT format perform the following actions:

- Choose **Vectors** > **Export** > **ATLAS KLT**. The **Export to ATLAS KLT format** window opens.

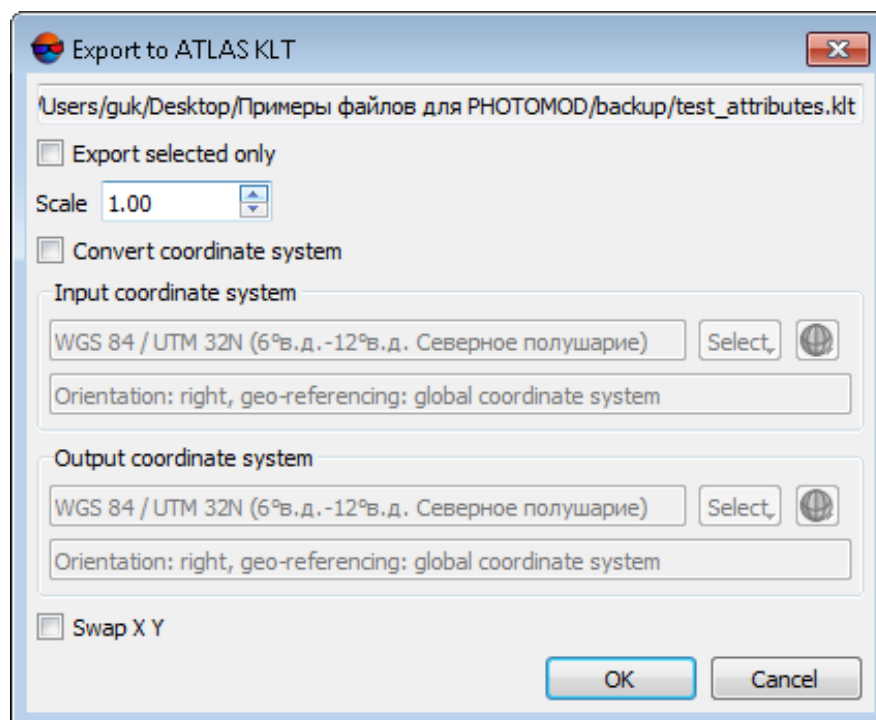

Fig. 246. Export to ATLAS KLT format

- Define the following parameters of datum: [optional] In order to export just selected points, set the **Export selected only** checkbox.
 - **Export selected only** – allows to export only selected object from active layer;
 - **Scale** – allows to change scale that adds in the head of file.



Scale value adds in the head of ATLAS KLT file. By default scale is 10 000.

- [optional] In order to define additional parameters set the **Swap X Y** and **Convert coordinate system** checkboxes on (see [Section 10.5](#)).



If the **Swap X Y** checkbox is set off, the vector objects will be exported in the right coordinate system. Otherwise, in the left one.

- Click OK to complete the export operation.

14.8. Export to KML / KMZ

The system provides possibility of vector objects export to KML (KMZ) format. Files of this format has the *.kml (*.kmz) extension.



Vector objects in local coordinate system could not be exported in the KML (KMZ) format. To perform export change the coordinate system to the global one (see [Section 10.5.2](#)).

In order to export vector objects to KML (KMZ) format perform the following actions:

- Select **Vectors** > **Export** > **KML, KMZ**. The **Export to KML / KMZ format** window opens.

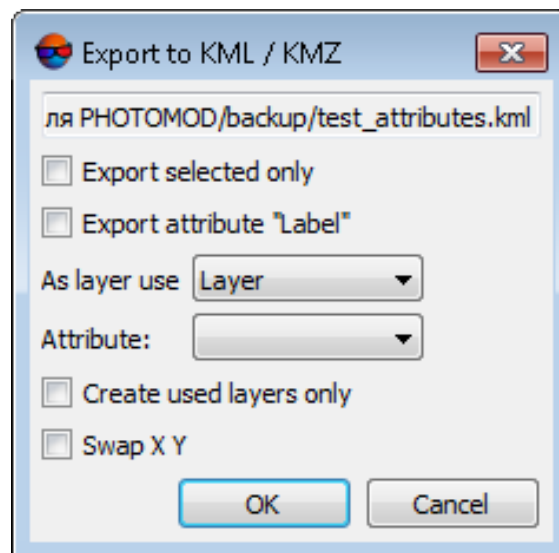

Fig. 247. Export to KML / KMZ format

- Specify the following parameters of export:

- **Export selected only** – allows to export only selected object from active layer;

- **Export attribute “Label”** – allows to export special object labels (see [Section 6.5](#));
- **Use as layer** – allows to choose what to assign vector objects after export;



The system allows to use assigning by classifier layer, object code, name of this code or attribute value. When vector objects are assigned by attribute value, choose **Attribute** in the list.

- **Create used layers only** – allows to export only classifier layers with vector objects;

3. [optional] To define additional parameters set the **Swap X Y** checkbox on (see [Section 10.5](#)).



If the **Swap X Y** checkbox is set off, the vector objects will be exported in the right coordinate system. Otherwise, in the left one.

4. Click OK to complete the export operation.

14.9. Export to LAS

The system provides possibility of vector objects export to LAS format (see the “[LIDAR Data processing](#)” User Manual). Files of this format has the *.las extension.

In order to export vector objects to LAS format perform the following actions:

1. Select **Vectors** › **Export** › **LAS**;
2. Specify the output LAS file location in *Windows* file system;
3. Click OK to complete the export operation.

14.10. Export to LIG

The system provides possibility of vector objects export to LIG format. Files of this format has the *.lig extension.

In order to export vector objects to LIG format perform the following actions:

1. Select **Vectors** › **Export** › **LIG**. The **Export to LIG** window opens.

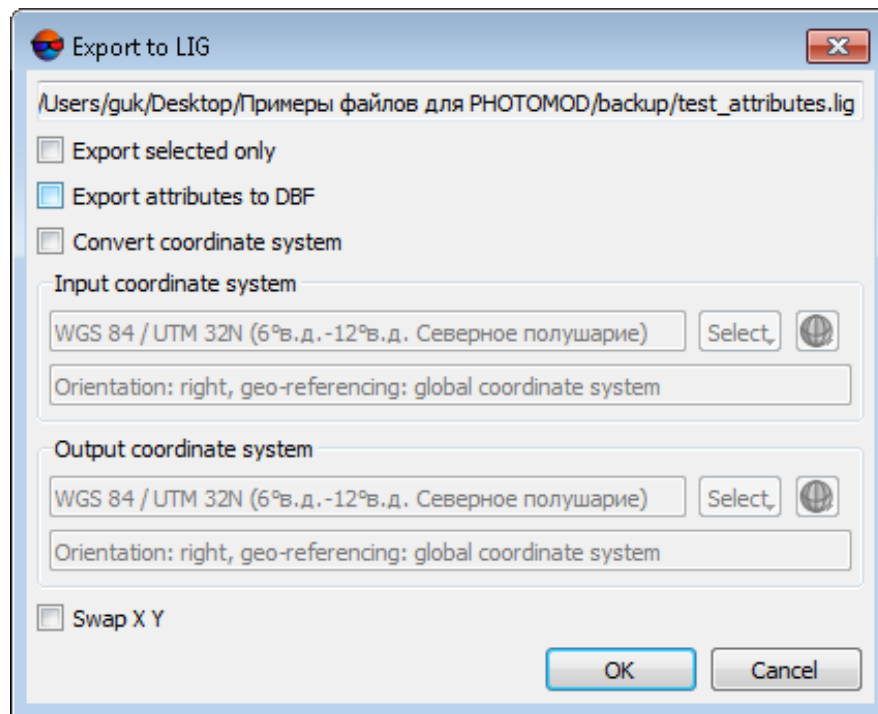

Fig. 248. Export to LIG format

2. Specify the following parameters of export:
 - **Export selected only** – allows to export only selected object from active layer;
 - **Export attributes to DBF** – allows to create file with with attribute information about objects, as well as for assigning vector objects to classifier.
3. [optional] In order to define additional parameters set the **Swap X Y** and **Convert coordinate system** checkboxes on (see [Section 10.5](#)).
4. Click OK to complete the export operation.

14.11. Export to MIF / MID

The system provides possibility of export to MIF/MID format. The MIF/MID format is the exchange format with `mif` extension, that is used in the *MapInfo* system.



When exporting to MIF/MID format it is not allowed to use space in attributes names. Replace all spaces in attribute names with underscores.

In order to export vector objects to MIF/MID format perform the following actions:

1. Choose **Vectors** > **Export** > **MIF/MID**. The **Export to MIF/MID** window opens.

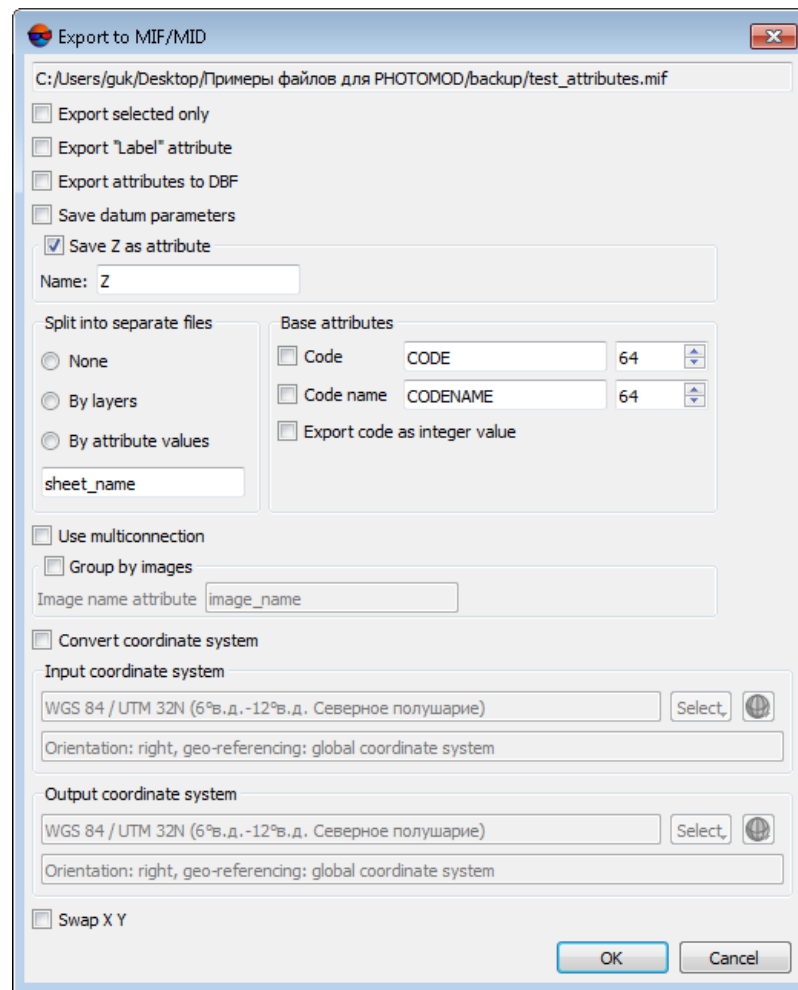



Fig. 249. Export to MIF/MID format

2. [optional] In order to export just selected points, set the **Export selected only** checkbox.
3. Specify the following parameters of export:
 - [optional] the **Export selected only** checkbox allows to export only selected object from active layer;
 - [optional] the **Export Label attribute** checkbox allows to export special object labels (see [Section 6.5](#));
 - [optional] the **Export attributes to DBF** checkbox allows to create file with with attribute information about objects, as well as for assigning vector objects to classifier;
 - [optional] In order to export splitting into sheets as separate objects (for example, to export separately polygons that correspond to images borders, and separately

- “gaps”), set the **Use multiconnected** checkbox on. To merge separate objects with the same attributes (for example, to group just “gaps”) set the **Group by images** checkbox on and input attribute name into the **Image name attribute:** field;
- [optional] To preserve Z coordinate as attribute in classifier, set the **Save Z as attribute** checkbox and specify attribute name in the **Name** field;
 - [optional] The **Save datum parameters** checkbox allows to save seven parameters of coordinate system to metadata.
4. In the **Split into separate files** section specify one of the ways of export to a separate file:
 - **None** – all objects of opened layer are exported in one file;
 - **By layers** – each layer of classifier is exported to separate file, file is named with name of corresponding classifier layer;
 - **By attribute values** – used to export objects of opened layer by attribute value, which name is specified in this field below.
 5. [optional] In the **Base attribute** section choose classifier attributes for DBF-file: **Code** and/or **Code name**. Define their names and line length of attribute in correspondent fields.

 Attribute line has default length – 64 symbols. If it is necessary to display in *MapInfo* attributes with code with are not integer, set the **Export code as integer value** checkbox on.
 6. [optional] In order to define additional parameters set the **Swap X Y** and **Convert coordinate system** checkboxes on (see [Section 10.5](#)).

 If the **Swap X Y** checkbox is set off, the vector objects will be exported in the right coordinate system. Otherwise, in the left one.
 7. Click OK to complete the export operation. Two files with the same names is created. The first file has the *.mif extension and contains vector objects. The second file has the *.mid extension and contains attributes of these vector objects.

14.12. Export to PLY

The system provides possibility of vector objects export to PLY format. Files of this format has the *.ply extension.

In order to export vector objects to PLY format perform the following actions:

1. Select **Vectors** > **Export** > **PLY**. The **Export to PLY format** window opens.

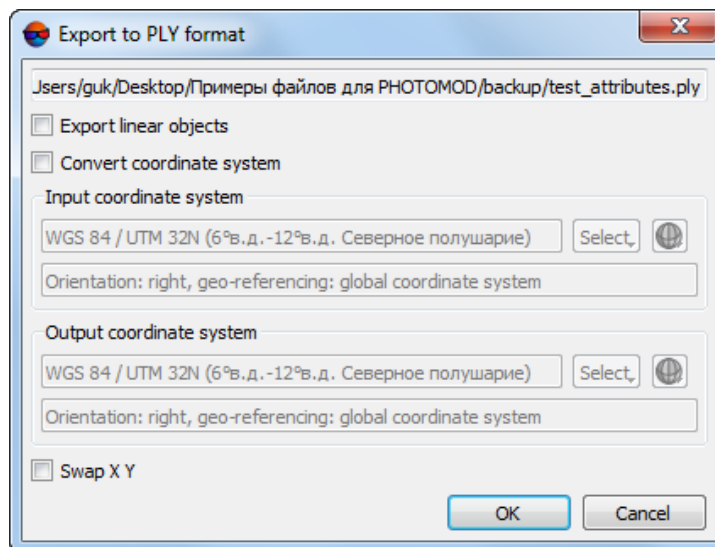

Fig. 250. Export to PLY format

2. [optional] In order to export just linear objects, set the **Export selected only** checkbox.
3. [optional] In order to define standard parameters set the **Swap X Y** and **Convert coordinate system** checkboxes on (see [Section 10.5](#)).



If the **Swap X Y** checkbox is set off, the vector objects will be exported in the right coordinate system. Otherwise, in the left one.

4. Click OK to complete the export operation.

14.13. Export to Shape

The system provides possibility of export to Shape format. This is exchange format with *.shp extension, that is used in *ArcInfo* system.

The Shape format consists of three files with the same names and following extensions:

- *.shp – main file, that contains information about objects; one *Shapefile* stores objects of the only one type – points, polylines or polygons;
- *.shx – additional index file, that contains information about objects position in the main file; it is used to speed up access to the content of the shape-file;
- *.dbf – additional file containing the table of DBF database (see [Section 13.14](#)).

- *.prj – additional file containing parameters of project projection.

In order to export vector objects to Shape format perform the following actions:

1. Select **Vectors** › **Export** › **Shape**. The **Export to Shape** window opens.

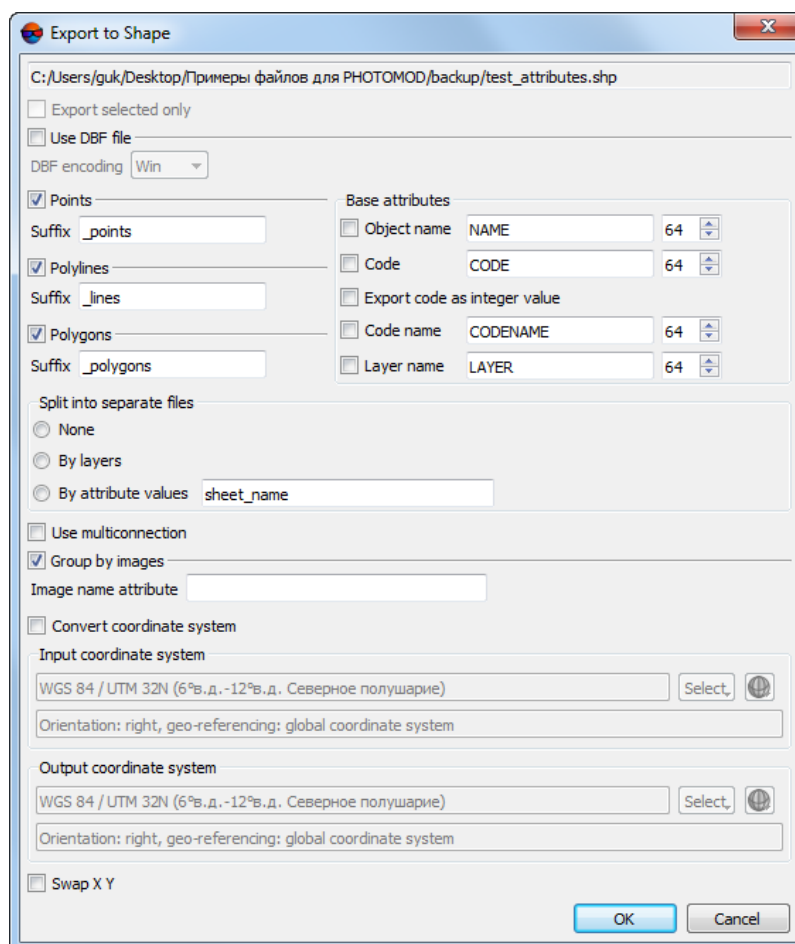

Fig. 251. Export to SHP format

2. Specify the following parameters of export:

- **Export selected only** – allows to export only selected object from active layer;
- **Export attributes to DBF** – allows to create file with with attribute information about objects, as well as for assigning vector objects to classifier.
 - Select DBF file encoding, **Win** or **UTF-8**.



UTF-8 encoding may be necessary for correct export of Cyrillic characters.

3. Select object types for export: **Points**, **Polylines**, **Polygpns** and specify names of objects types.
4. In the **Split into separate files** section specify one of the ways of export to a separate file:
 - **No** – used to export all objects of one layer to a single file.
 - **By layers** – used to export each layer to separate file; each file receives the name of the corresponding layer;
 - **By attribute values** – used to export objects of opened layer by attribute value, which name is specified in this field.
5. [optional] To specify code names in classifier of the DBF file, in the **Base attributes** section the **Object name**, **Code**, **Code name**, and **Layer name** checkboxes are set on by default.



Attribute line has default length – 64 symbols. If it is necessary to display in *ArcInfo software* attributes with code with are not integer, set the **Export code as integer value** checkbox on.

6. [optional] In order to export splitting into sheets as separate objects (for example, to export separately polygons that correspond to images borders, and separately “gaps”), set the **Use multiconnection** checkbox on. To merge separate objects with the same attributes (for example, to group just “gaps”) set the **Group by images** checkbox on and input attribute name into the **Image name attribute:** field.
7. [optional] In order to define additional parameters set the **Swap X Y** and **Convert coordinate system** checkboxes on (see [Section 10.5](#)).



If the **Swap X Y** checkbox is set off, the vector objects will be exported in the right coordinate system. Otherwise, in the left one.

8. Click OK to complete the export operation.

14.14. Export to Panorama / SXF

The system provides possibility of vector objects export to the Panorama or *.sxf (*.txf) format. The Panorama format is exchange format with *.sit and *.map extensions, that is used in *GIS Map* system.

SXF (Storage and eXchange Format) is the open format for terrain digital information. This format was developed in 1992 by the Topographic Service of the Armed Forces of the Russian Federation and in 1993 was approved as the main exchange format for terrain digital information for the Russian Armed Forces and for some federal services

of the Russian Federation. There are the binary and text (*.txf) forms of data storage in the SXF format.

In order to export vector objects to Panorama / SXF format perform the following actions:

1. Select **Vectors** > **Export** > **Panorama/SXF**. Specify the export file name and click the **Save** button. The **Export to Panorama/SXF** window opens:

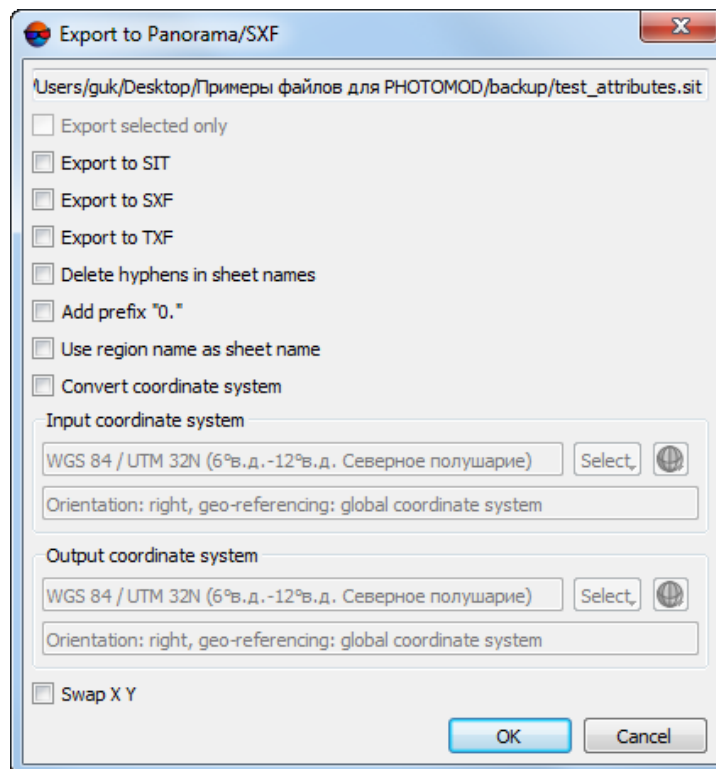

Fig. 252. Export to Panorama / SXF

2. [optional] In order to export just selected points, set the **Export selected only** checkbox;
3. Set or clear the following checkboxes to select at least one export format:
 - **Export to SIT**;
 - **Export to SXF**;
 - **Export to TXF**.



At least one format must be chosen (for that reason, if only one checkbox is set, the program will not allow you to clear it).

4. [optional] In order to **delete hyphens in sheet names**, set the appropriate checkbox;

5. [optional] To **use region name as sheet name**, set the appropriate checkbox (recommended for further data processing in *GIS Map*);



If the checkbox is cleared, a user-entered file name is used as a sheet name (see above).

If the checkbox is set, the **District name** entered by the user is used as a sheet name (see below).

6. [optional] To define standard parameters set the **Swap X Y** and **Transform reference system** checkboxes on (see [Section 10.5](#));



If the **Swap X Y** checkbox is set off, the vector objects will be exported in the right coordinate system. Otherwise, in the left one.

7. Click OK. The **Creation of Panorama map** window opens:

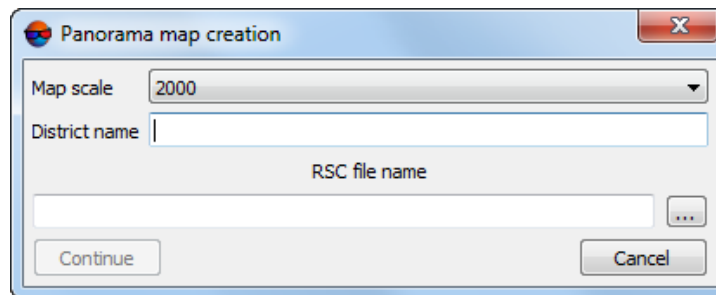

Fig. 253. Creation of Panorama map

8. Select in the list the **map scale** to create a map of particular scale (in a range from 2 000 to 1 000 000);
9. In the **District name** field input necessary name;
10. In the **Output file** section click the **...** button to choose classifier file (with *.rsc extension);
11. Click the **Continue** button to complete the export.

14.15. Batch export of layers

The system provides possibility of batch vector objects export to separate files with the same extension.

To export multiple vector layers perform the following actions:

1. **Open** at least two vector layers.

2. Select **Vectors** › **Export** › **Batch export of layers**. The **Export opened vector layers** window opens.

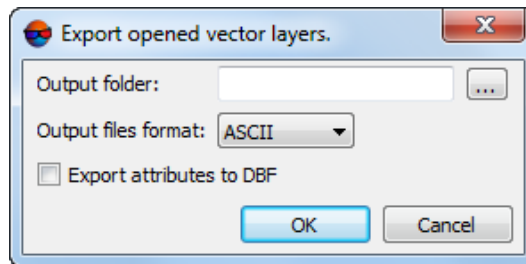

Fig. 254. The Export opened vector layers window

3. Click the **...** button to choose destination folder for files export.
4. Choose one of the following formats from the list:
 - ASCII;
 - ASCII-A;
 - CSV;
 - DGN;
 - DXF;
 - Generate;
 - ATLAS KLT;
 - KML;
 - LIG;
 - MIF/MID;
 - PLY;
 - Shape;
 - Panorama.
5. Set the export parameters, according to the chosen format.
6. Click OK to export multiple vector objects to separate files with the same extension.

14.16. Batch export of resources

The system provides possibility of batch vector objects export from resources to separate files with the same extension.

To do this perform the following actions:

1. Select **Vectors** > **Export** > **Batch export of resources**. The **Parameters** window opens.

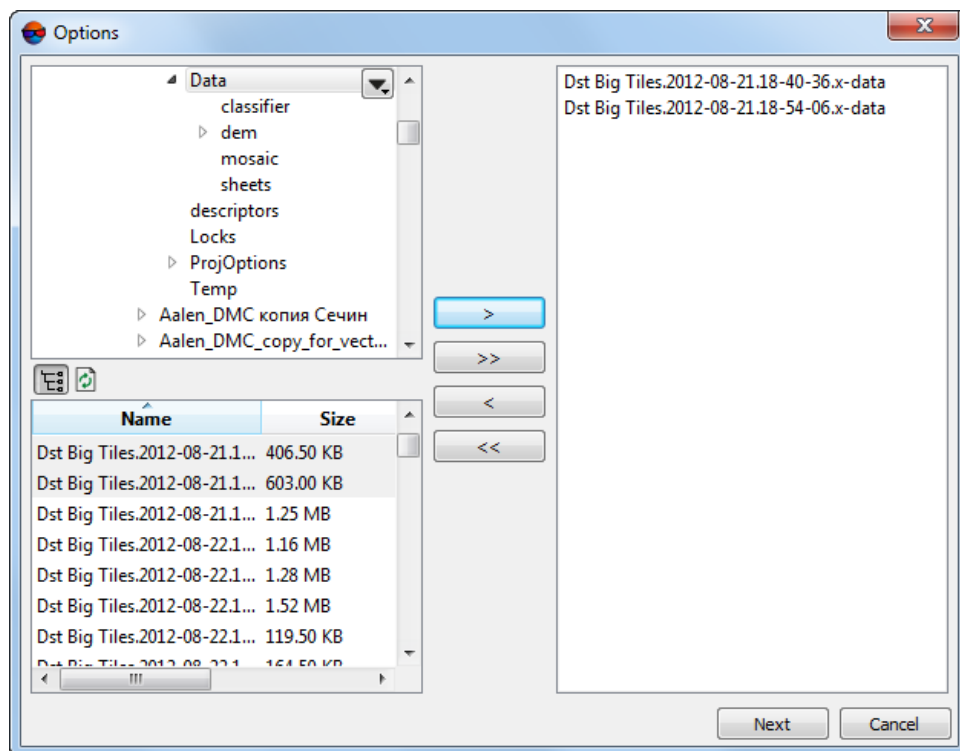











Fig. 255. The Parameters window

2. Choose a folder containing vector objects in resources tree.

 The  button allows to display all available resources in nested files. The  button allows to refresh part of the window with resources.

 The  button allows to show a list with 10 recently selected resources.

3. Select file with vector objects in the list and click the  button to add a layer.

 The  and  buttons allow to add to the list or remove from it all added files with vector objects, the  button allows to remove selected file from the list.

4. Repeat the 2 and 3 steps to add next files with vector objects.
5. Click the **Next** button. The **Options** window opens.

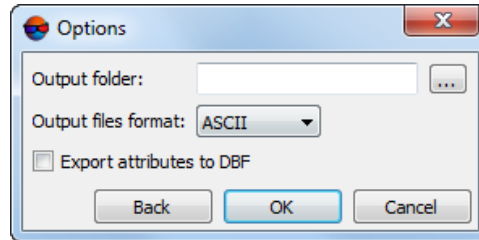

Fig. 256. The Options window

6. Click the **...** button to choose destination folder for files export.
7. Choose one of the following formats from the list:
 - ASCII;
 - ASCII-A;
 - CSV;
 - DGN;
 - DXF;
 - Generate;
 - ATLAS KLT;
 - KML;
 - LIG;
 - MIF/MID;
 - PLY;
 - Shape;
 - Panorama.
8. Set the export parameters, according to the chosen format.
9. Click OK to export multiple vector objects to separate files with the same extension.

15. Generators of splitting into sheets

15.1. Standard orthomap sheet frames generator

The program provides possibility to split survey area for notation sheets of chosen scale, which consist of vector polygons.

Generators of splitting into sheets are used to:

- to split orthomaps into sheets by images;
- for further use in the *GeoMosaic* program;
- for contours sheets export.

Perform the following to split survey area to notation sheets of chosen scale:

1. Choose **Vectors** > **Create standard orthomap sheet frames**. The **Generate standard sheets** window opens.

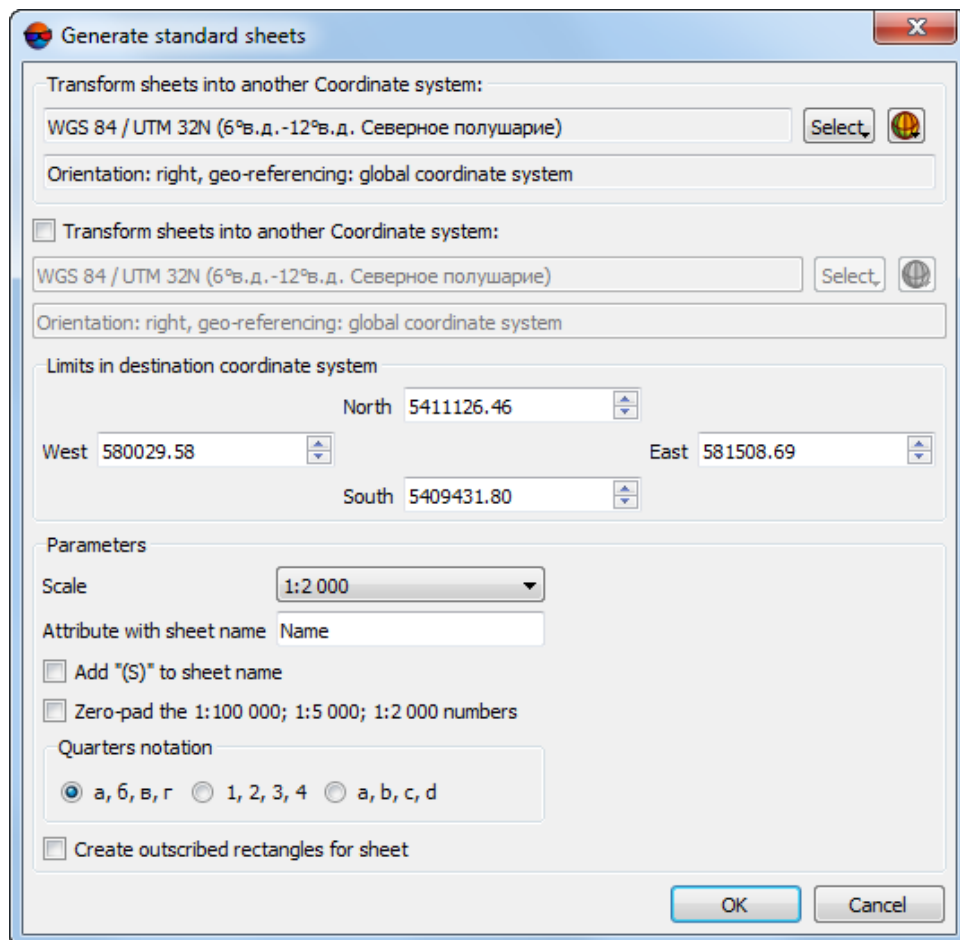

Fig. 257. Standard orthomap sheet frames generator parameters

2. In the **Geographic coordinate system** section choose the input coordinate system, which is used to specify splitting into sheets by latitude and longitude.
3. In the **Destination coordinate system** section choose the coordinate system to recalculate coordinate system of sheets during splitting into sheets (coordinate system of the project, for example).
4. In the **Limits in destination coordinate system** section are specified coordinates of area borders for splitting into sheets. To change area size input coordinates of corners in the **North, West, East, South** fields.



The program provides possibility to split survey area for **predefined by user** notation sheets of chosen scale.

5. Choose the scale of orthomap in the **Scale** section.
6. In the **Parameters** section define the following settings:
 - **Attribute with sheet name** – allows to define the name of attribute to write the sheet names;
 - **Add “(S)” to sheet name** – allows to clarify map position, located in south hemisphere;
 - **Zero-pad the 1:100 000 number** – allows to add zeros before zone numbers to notation for lists of 1:100 000 scale;
 - **Quarters notation** – allows to choose type of quarters notation.
7. [optional] In case when 1:5 000 or 1:2 000 scale is chosen, set on the **Create outscribed rectangles for sheet** checkbox.
8. Click OK. After that the system starts the splitting orthomaps into sheets with specified notation.

The figure below displays an example of splitting of the survey area on map sheets with the following data: orthophotomap scale – 1:200 000; geographic coordinate system – Latitude-Longitude Pulkovo 1942; target coordinate system – SK-42, Zone 6.

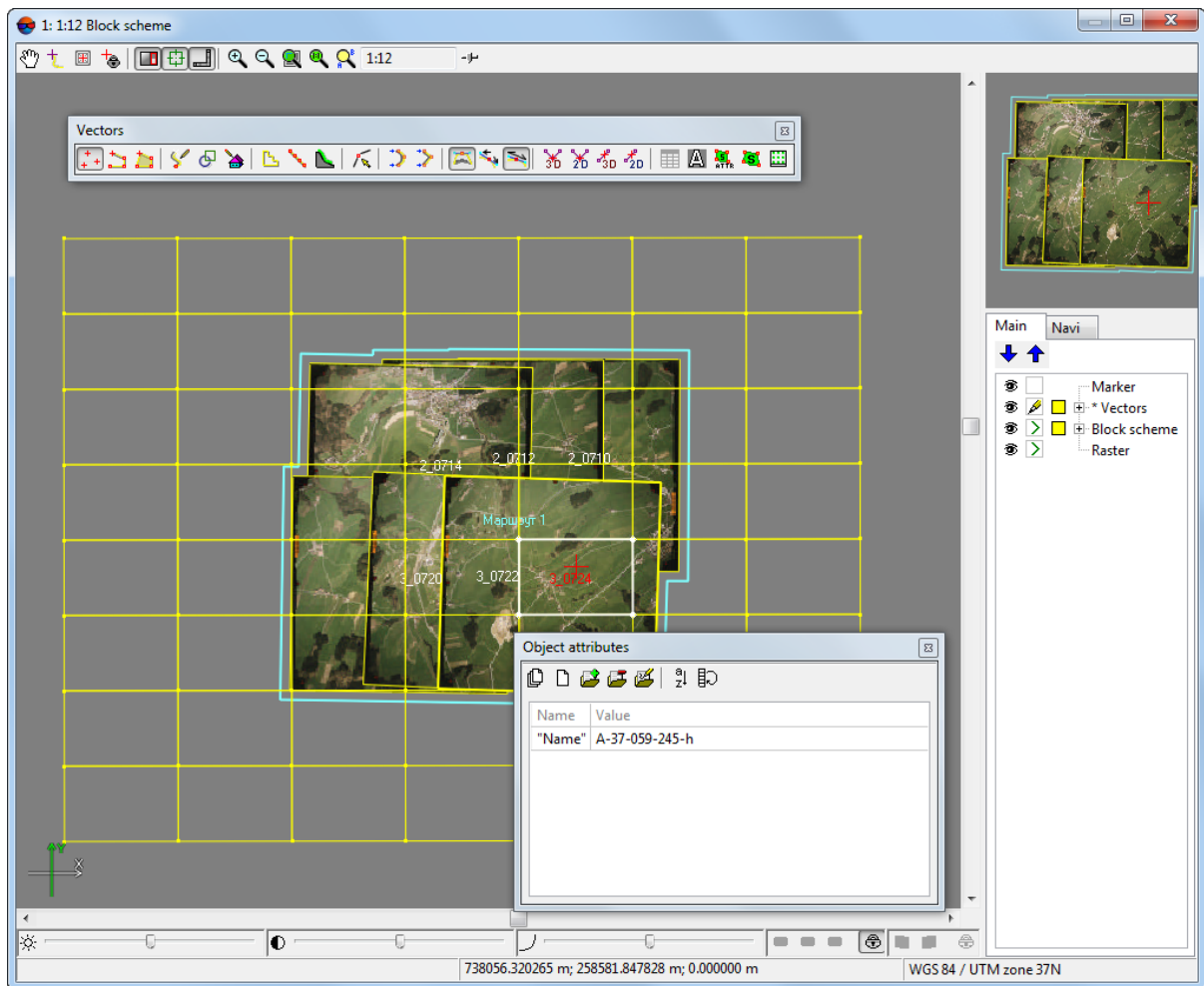

Fig. 258. Example of splitting orthomaps into sheets with specified notation

15.2. Custom orthomap sheet frames generator

Program provides possibility creating sheets from several orthomaps, merged by cutlines and created in local coordinate system.

Perform the following to split orthomaps by notation sheets in local coordinate system:

1. Choose **Vectors** > **Create custom orthomap sheet frames**. The **Generate arbitrary sheets** window opens.

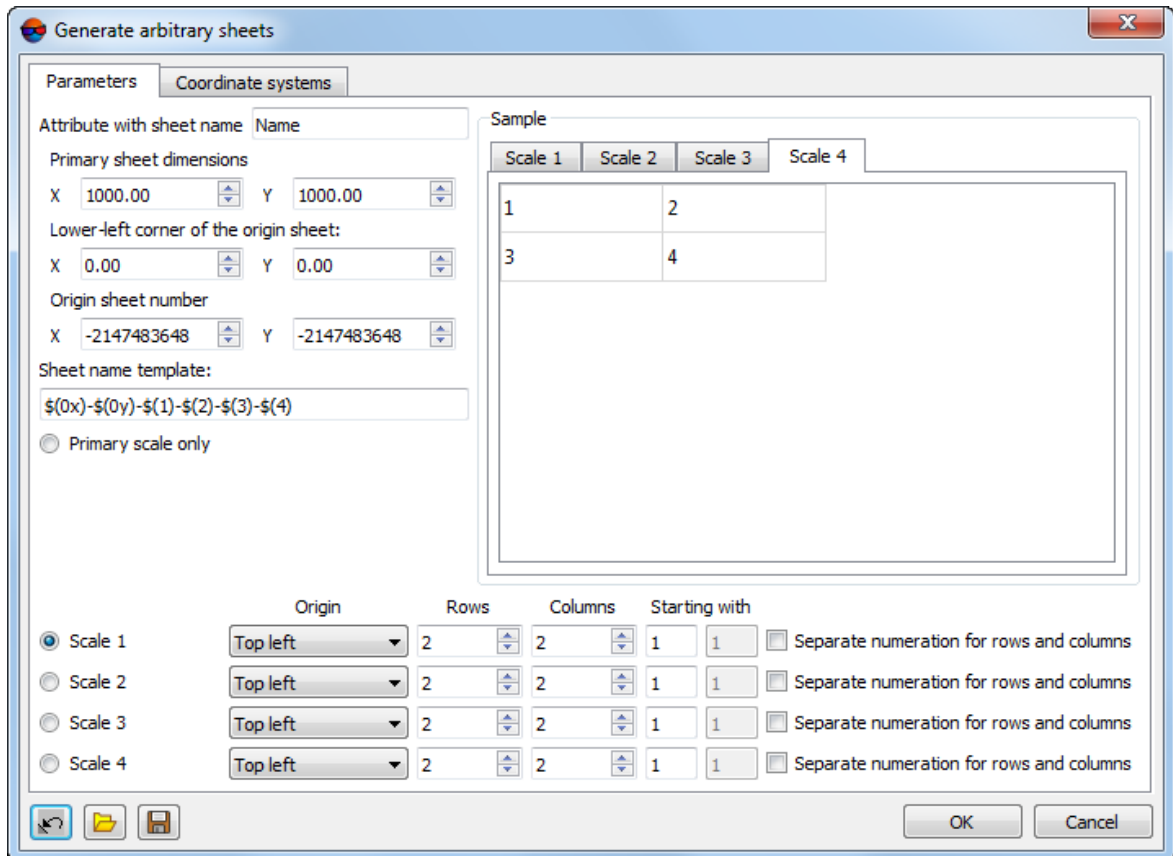





Fig. 259. Custom orthomap sheet frames generator parameters

The bottom toolbar of window contains the following buttons:

-  – allows to reset parameters to default;
-  – allows to load parameters from the file;
-  – allows to save parameters into a file.

2. Specify the following parameters of primary scale sheet:



In case of using the custom orthomap sheet frames generator it is possible to use up to 5 levels of splitting orthomaps into sheets: primary and 4 additional scales. Each next level is created by splitting the previous level.

- **Attribute with sheet name** – allows to define the name of attribute to write the sheet names;
- **Primary sheet dimension** – the primary scale sheet size;
- **Lower-left corner of the origin sheet** – allows to set coordinates of the origin sheet;



Choose the reference point lower and left from work area.



The coordinates of origins of the others sheets are calculated based on this information.

- **Origin sheet number** – allows to input a number of sheet that starts numeration;
- **Sheet name template** – displays the template by which sheet names are created. By default, \$(0x) -\$(0y) -\$(1) -\$(2) -\$(3) -\$(4), where
 - \$(0x) – number by X on primary scale;
 - \$(0y) – number by Y on primary scale;
 - \$(1), \$(2), \$(3), \$(4) – number on the first and next levels in case if the **Separate numeration for rows and columns** checkbox is set off;
 - \$(1x) – number by X in case if the **Separate numeration for rows and columns** checkbox is set on;
 - \$(1y) – number by Y in case if the **Separate numeration for rows and columns** checkbox is set on;

Notation adds as attribute of each sheet.



If template does not correspond to selected number of splitting levels, attributes are created incorrectly correct.

3. [optional] To use only one base list choose **Primary scale only** and click OK. Otherwise move to the 7 step.
4. Specify the following parameters of primary scale sheet:
 1. Choose number of additional levels of splitting: **Scale 1, Scale 2, Scale 3, Scale 4.**
 2. Select origin of sheets of additional level in the **Origin** list.
 3. Define number of **Rows** and **Columns** for each level.
 4. Define arbitrary symbol (letter or number) as a start sheet number in the **Starting with** field.



Notation with all types, except using Roman numerals, could be created.

- [optional] Sheets is numbered sequenced by row. To change numeration order set the **Separate numeration for rows and columns** checkbox on.



All changes of parameters are shown in the **Sample** table.

- In Coordinate systems tab specify the following parameters:

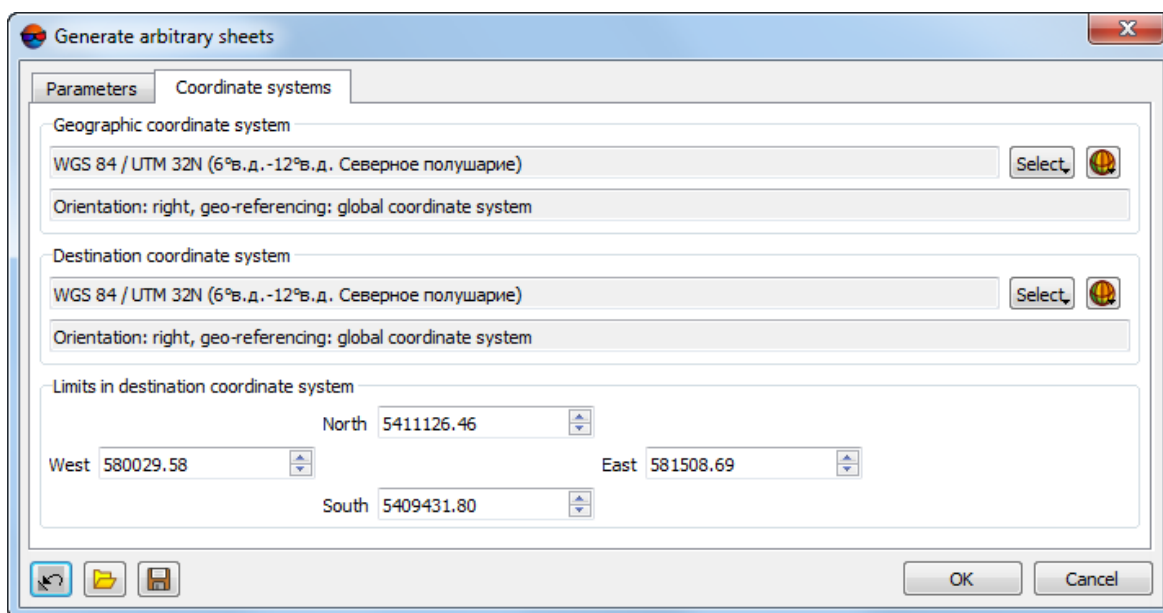

Fig. 260. Custom orthomap sheet frames generator parameters

- In the **Geographic coordinate system** section choose the input coordinate system, which is used to specify splitting into sheets by latitude and longitude.
 - In the **Destination coordinate system** section choose the coordinate system to recalculate coordinate system of sheets during splitting into sheets (coordinate system of the project, for example).
 - In the **Limits in destination coordinate system** section are specified coordinates of area borders for splitting into sheets. To change area size input coordinates of corners in the **North, West, East, South** fields.
- Click OK. After that the system starts the splitting orthomaps into sheets with specified notation. New vector layer creates. Sheets are displayed in 2D-window.

15.3. Standard orthomap sheet frames importer

The program provides possibility to split survey area for predefined by user notation sheets of chosen scale, which consist of vector polygons. The names of notation sheets are specified in input CSV-file with *.csv or *.txt extension.



The program provides possibility to split survey area for notation sheets of chosen scale, by [setting the coordinates of area borders for splitting into sheets](#).

An input CSV-file must meet the following requirements:

- Names of notation sheets in input *.csv or *.txt files must be sequentially rowwise arranged. Field delimiter symbols as **comma**, **space**, **tab**, **semicolon** or **other** are not applicable;
- An input CSV-file must contain names of notation sheets of only one scale;
- Names of notation sheets in the input CSV-file must contain a unified **Quarters notation**;
- All names of notation sheets in the input CSV-file must have either only standard or only numeric form;
- The input CSV-file must contain the names of notation sheets located in one hemisphere.

Perform the following to split survey area to predefined notation sheets of chosen scale:

1. Choose **Vectors › Import standard orthomap sheet frames**. The **Import standard sheets** window opens.

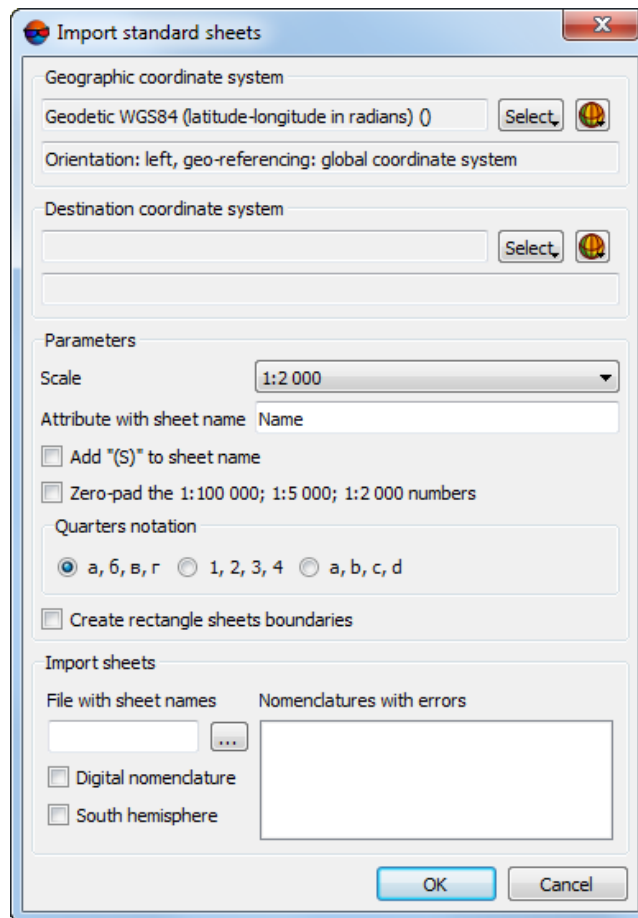

Fig. 261. Standard orthomap sheet frames import parameters

2. In the **Geographic coordinate system** section choose the input coordinate system, which is used to specify splitting into sheets by latitude and longitude.
3. In the **Destination coordinate system** section choose the coordinate system to recalculate coordinate system of sheets during splitting into sheets (coordinate system of the project, for example).
4. In the **Scale** section choose the scale of notation sheets, which names will be imported.



An input CSV-file must contain the names of notation sheets of the same **scale** which matches the selected one;

5. In the **Parameters** section define the following settings:
 - **Attribute with sheet name** – allows to define the name of attribute to write the sheet names;

- **Add “(S)” to sheet name** – allows to clarify map position, located in south hemisphere;
- **Zero-pad the 1:100 000 number** – allows to add zeros before zone numbers to notation for lists of 1:100 000 scale;
- **Quarters notation** – allows to choose type of quarters notation.



The names of notation sheets in the input CSV-file must contain a unified **Quarters notation** which matches the selected one;

6. [optional] In case when 1:5 000 or 1:2 000 scale is chosen, set on the **Create outscribed rectangles for sheet** checkbox;
7. In the **Import sheets** section click the  button, to select input CSV-file with **sheet names** with *.csv or *.txt extension;



Names of notation sheets in input *.csv or *.txt files are sequentially rowwise arranged. Field delimiter symbols as **comma**, **space**, **tab**, **semicolon** or **other** are not applicable.

8. [optional] In case when notation sheets have solely numeric names, set on the **numeric names** checkbox;



All names of notation sheets in the input CSV-file must have either standard or numeric form.



In numeric form of notation sheets names, each letter denoting zones is replaced by double figures. These figures correspond to the counting number of the zone (or the letter in the Latin alphabet). For example, A — 01, B — 02, C — 03, D — 04, E — 05, and F — 06. The numeric notation of a sheet of 1:1 000 000 K-38 map will be 11-38. Each sheet of 1:200 000 map is denoted by a double figure from 01 to 36, and 1:100 000 map is denoted by three figures from 001 to 144. Letters in 1:500 000, 1:50 000, and 1:25 000 map sheet notations are replaced by the figures 1, 2, 3, and 4, respectively.

Table 16. Numeric form of notation sheets names for 1:1 000 000 - 1:25 000 scales

Map scale	Standard notations	Numeric notations
1:1 000 000	K-38	11-38
1:500 000	K-38-Б	11-38-2
1:200 000	K-38-XXXVI	11-38-36
1:100 000	K-38-99	11-38-099
1:50 000	K-38-99-B	11-38-099-3
1:25 000	K-38-99-B-Г	11-38-099-3-4

9. [optional] In case when notation sheets are located in southern hemisphere, set on the **South hemisphere** checkbox;



An input CSV-file must contain the names of notation sheets located in one hemisphere.

10. Click OK. After that the system starts the splitting orthomaps into sheets with specified notation.

If errors are detected in the input CSV-file, the operation fails. An information message showing the number of detected errors appears. The names of notation sheets with errors are displayed in the **Names with errors** field.

16. Co-editing vector layers

The system provides an algorithm for collaborative editing of a vector layer by several users at once. The program allows for coordination of operators' actions by tracking changes made to the vector layer in different units of *PHOTOMOD*. This allows us to optimize the processing of large arrays of vector data, performed simultaneously on several workstations, while avoiding the shortcomings that may arise when editing the same resource by different users.



First of all, this functionality was developed to facilitate the work with the so-called *cutlines*, i.e. topologically connected vector polygons, created in *PHOTOMOD Geomosaic* (see "Cutlines creation" in the "Orthophotomaps creation" User Manual and the recommendations in [Section 16.1](#)).

Vector layers available for co-editing have *.cx-data extension. The entire set of tools and functionality of the system, designed to work with "standard" vector layers, is also available for co-edited layers, unless otherwise noted.



Co-editing is not supported for [layers with a classifier](#).

Collaborative editing means simultaneous processing of *different* objects of the same vector layer by several operators. Coordination of user actions is achieved by tracking the state of each individual vector object and the algorithm for saving the changes made, taking into account the actions of all operators:

- If a user has edited only "their" objects (not affected by other operators since the layer was loaded in the current *PHOTOMOD* module), the vector layer is **saved** as usual;
- If, during a session with a layer, the user has made changes to at least one object that was simultaneously edited (saving data) in another *PHOTOMOD* module, then, when trying to overwrite data, a dialog box is displayed notifying the user about the conflict that has arisen.

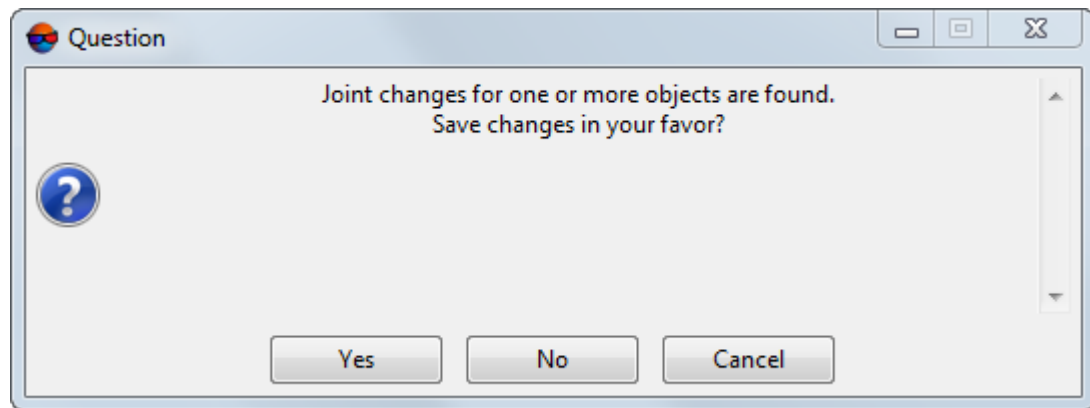

Fig. 262. A dialog box

The user can:

- Save their changes – force save changes in all objects edited by them, including co-edited objects, overwriting the changes made to these objects by other users by clicking **Yes**;
- Overwrite only “their own” edited objects, without introducing “their own” changes to objects that have already been processed by other operators, from the moment the layer was loaded in the current *PHOTOMOD* unit, by clicking **No**;
- Cancel saving vector layer.



The system does not provide for highlighting conflict vector objects, as well as for displaying their number. However, for co-edited vector layers, as well as for “common” vector objects, it is possible to [cancel editing](#).

In this case, if sequential cancellation of editing operations is carried out after saving the data, then sequentially, in order of priority, all recent changes made to vector objects (in current *PHOTOMOD* unit) are canceled - both by the current user and by other operators. Operations with the action log are taken into account when checking for shared changes of vector objects before saving the layer.

Despite the fact that the functionality of co-editing greatly facilitates group work with data, in order to optimize the process of stereovectorization, users are strongly recommended to split the work among themselves within the vector layer being processed, and also to [save](#) the results of their efforts quite often, especially when processing topologically connected objects (see below).

After the layer has been saved (regardless of the save mode selected by the user), the information in the 2D window of the program is updated, displaying the last saved version of the data, taking into account the changes made by all operators

To load the last saved version of the active vector layer without saving “your” changes, choose **Vectors** > **Revert**. The 2D window of the program displays the last saved changes in the active layer made by other users (if there are such changes).

The algorithm for co-editing of vector objects takes into account not only changes made directly to the objects themselves, but also operations with [vector object attributes](#) (created in a layer without a classifier).

The system does not provide for co-editing various *elements of the same object* by different users – the fact of shared changes will be recorded in any case, even if different elements (or attributes) of the object in question were changed by operators

16.1. Co-editing topologically connected vector objects

When several users work in groups on a co-edited vector layer, special attention should be paid to topological operations, i.e. work with [topologically connected objects](#), since the changes made affect not only this particular object, but also its neighbors topologically connected to it.

A special case of topologically connected objects are the so-called *cutlines* that are topologically connected vector polygons created by *PHOTOMOD Geomosaic*. In case of automatic cutline creation, the resulting vector layer is primarily available for collaborative editing by several users and has *.cx-data extension (see “Cutlines creation” in the “[Orthophotomaps creation](#)” User Manual).

Despite the fact that the functionality of vector object co-editing greatly facilitates manual *cutline* co-editing in *PHOTOMOD Geomosaic*, users are strongly recommended to split the work among themselves and pay special attention to the actions performed at the “junctions” of their work areas, and also save the results of their work quite often.

When working with *cutlines*, it is recommended to use the “save your changes” functionality carefully. If, when working with topologically unconnected vector objects, this operation can simply lead to the loss of the results of the work of one or several operators, then, with incoordinated deletion, addition or movement of the node vertices of cutlines, it is very likely that extremely undesirable elements will appear in the layer with cutlines – so-called “gaps” (see “[Orthophotomaps creation](#)” User Manual).

When copying *PHOTOMOD GeoMosaic* projects containing cutlines, it is important to pay special attention to whether the **vector data link to the project** (see “General parameters” in the “[Orthophotomaps creation](#)” User Manual).

17. ArcSync. Synchronized vector edition

17.1. The main window of ArcSync

The **ArcSync: Synchronize to ArcInfo map** window is used to terrain objects vectorization at the same time in the PHOTOMOD system and in third-party software.

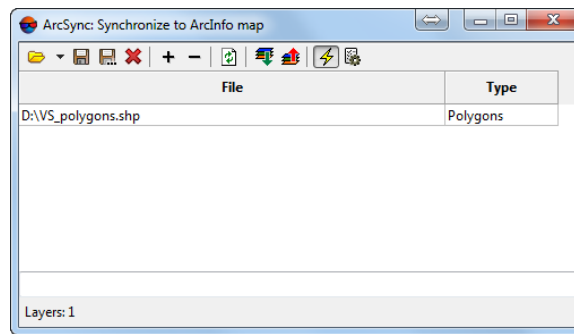













Fig. 263. The main window of ArcSync

List of synchronization files is a table. File path is displayed in the **File** column. In the **Type** column is displayed type of object chosen in layer export (points, polylines or polygons).

The **ArcSync: Synchronize to ArcInfo map** window toolbar contains the following buttons:

-  – allows to open created ArcSync map;
-  – allows to save vector layers as ArcSync map;
-  – allows to save vector layers as ArcSync map using unique name;
-  – allows to close ArcSync map or added layers;
-  – allows to add vector layer in the table;
-  – allows to remove vector layer from the table;
-  – allows to synchronize maps manually;
-  – allows to import opened layer into 2D-window;
-  – allows to save opened layers in a Shape-file;
-  – allows to enable auto synchronization mode;
-  – allows to setup auto synchronization parameters.

17.2. Workflow

To terrain objects vectorization at the same time in the PHOTOMOD system and in third-party software is used the *ArcSync module*.

To Shape-files in Windows during simultaneously vector editing in PHOTOMOD and/or another program, changes add to files gradually. It is not required to save files again after editing.

It is recommended to create Shape-files in the third-party software or export vectors from PHOTOMOD.

To terrain objects vectorization at the same time in the PHOTOMOD system and in third-party software perform the following:

1. [optional] [Export vector layer to Shape-file](#).



During export polygons to a Shape format it is strongly recommended to set on all checkboxes **Export attributes to DBF** and **Polygons/Polylines/Points**.

2. Choose **Vectors** › **Import** › **Shape** in the system and import a vector layer. Imported layer displays in 2D-window.



If DBF file was created during export, set the **Use DBF-file** checkbox on.

3. Choose **Vectors** › **ArcSync** › **Map settings window** or click the  button of the **ArcSync** toolbar. The **ArcSync: Synchronize to ArcInfo map** window opens.

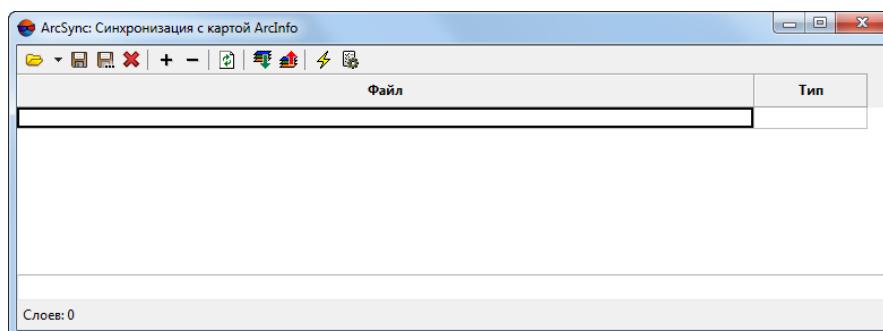

Fig. 264. The main window of ArcSync

4. Click the **+** button. The **Add files** window opens. Choose Shape file and click the **Open** button. The file adds to the table.

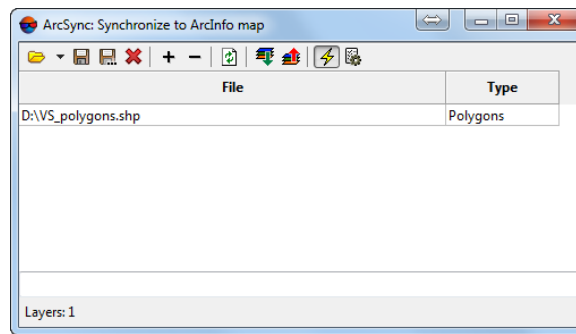

Fig. 265. Adding file in the table

5. Open second program and load the same vector file in it.

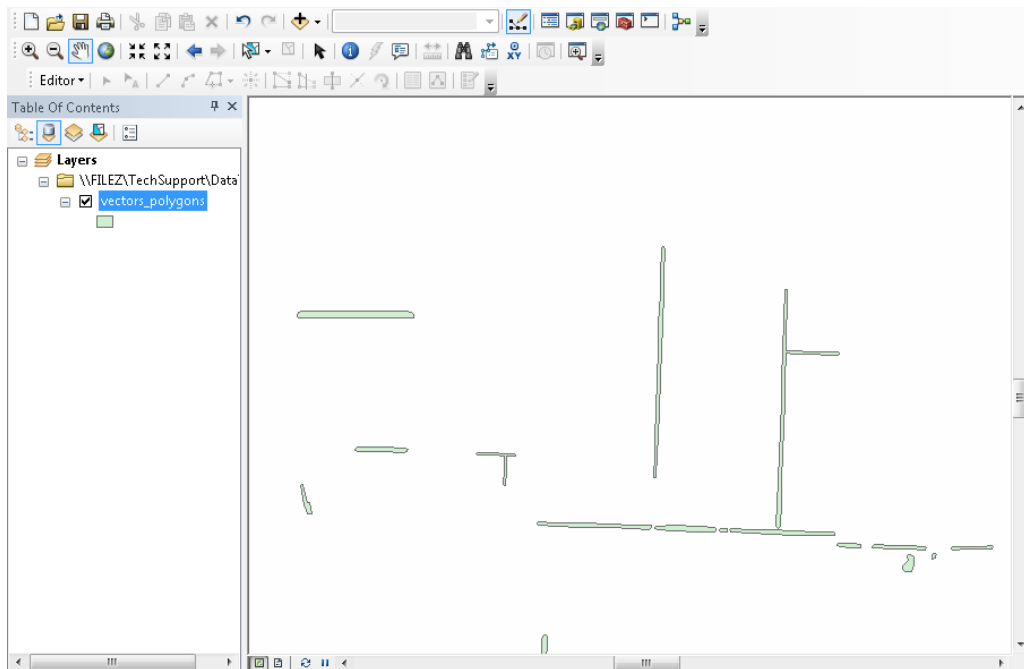

Fig. 266. Vector layer in the third party program

6. In the **ArcSync: Synchronize to ArcInfo map** window click the  button. The **Settings** window opens.

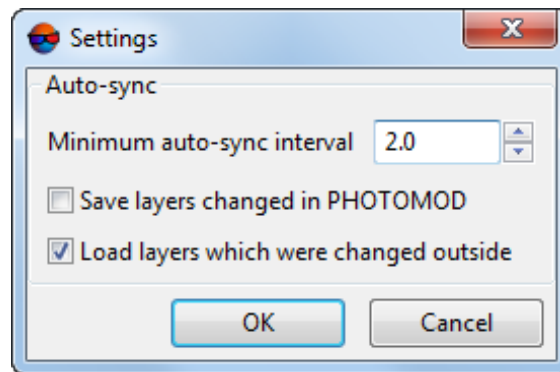

Fig. 267. Synchronization parameters

7. Define the **Minimum auto-sync interval** in seconds.
8. Set on one or more checkboxes:
 - **Save layers changed in PHOTOMOD** – changes made in PHOTOMOD are shown in the third-party program;
 - **Load layers which were changed outside** – changes made in the third-party program are shown in PHOTOMOD 2D-window.
9. Click OK to save parameters.
10. Click the ⚡ button. Auto-sync mode enables.

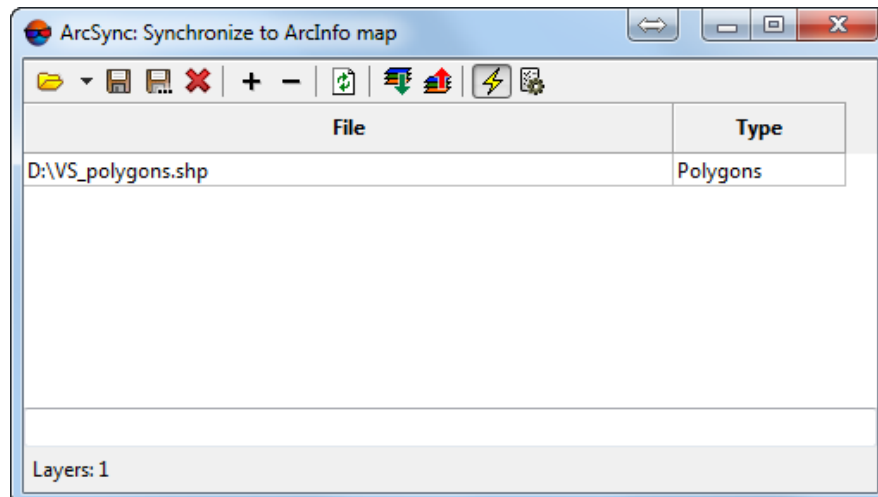

Fig. 268. Auto-sync mode is enabled

11. Change vector layer in the system.

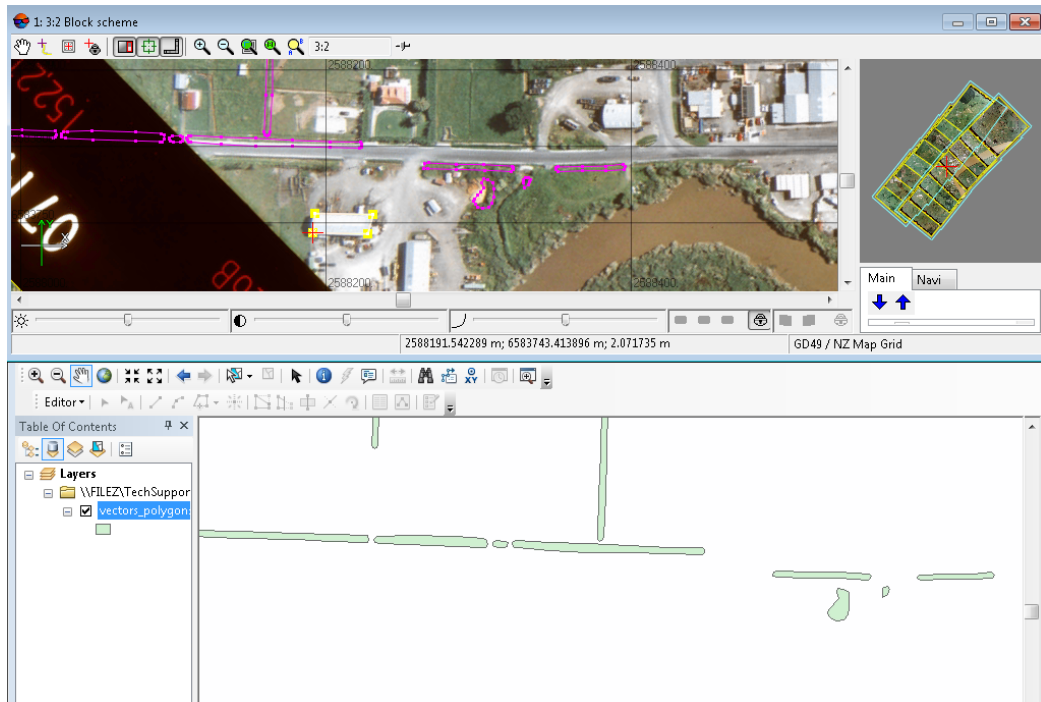

Fig. 269. Changes on vector layer in the system

12. In the other program click the **Refresh** button. As a result, changes display in this program.

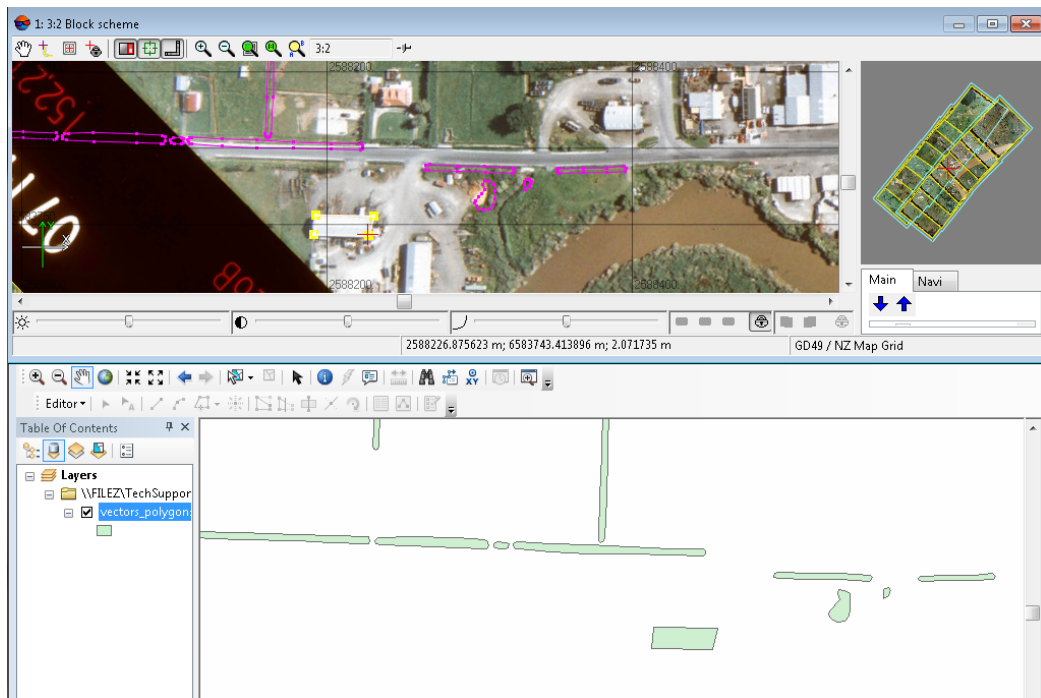



Fig. 270. Changes displaying in the third-party program

13. To save changes in file, in the **ArcSync: Synchronize to ArcInfo map** window click the  button.
14. To save changes in Shape-file of ArcSync format, in the **ArcSync: Synchronize to ArcInfo map** window click the  button and input filename.